

Neosys Technology Inc.

Nuvo-7000VTC Series

User Manual

Revision 1.8

Table of Contents

Table of Contents	2
Legal Information	5
Contact Information	6
Declaration of Conformity	6
Copyright Notice	7
Safety Precautions	8
Hot Surface Warning	8
Battery Warning	8
Service and Maintenance	9
ESD Precautions	9
Restricted Access Location	9
About This Manual	10
1 Introduction	
1.1 Nuvo-7100VTC Series Specifications	13
1.1.1 Nuvo-7100VTC Specifications	13
1.1.2 Nuvo-7104VTC Specifications	15
1.1.3 Nuvo-7108VTC Specifications	17
1.2 Nuvo-7200VTC Series Specifications	19
1.2.1 Nuvo-7200VTC Specifications	19
1.2.2 Nuvo-7204VTC Specifications	21
1.2.3 Nuvo-7208VTC Specifications	23
1.3 Nuvo-7250VTC Series Specifications	25
1.3.1 Nuvo-7250VTC Specifications	25
1.3.2 Nuvo-7254VTC Specifications	27
1.3.3 Nuvo-7258VTC Specifications	29
1.4 Isolated DIO Specifications	31
1.5 Supported CPUs	31
1.6 Nuvo-7100VTC Series Dimension	32
1.6.1 Nuvo-7100VTC Series Front Panel View	32
1.6.2 Nuvo-7100VTC Series Rear Panel View	32
1.6.3 Nuvo-7100VTC Series Top View	33
1.6.4 Nuvo-7100VTC Series Bottom View	34
1.6.5 Nuvo-7100VTC Series with Wall Mount Bracket	34
1.7 Nuvo-7200VTC Series Dimension	35
1.7.1 Nuvo-7200VTC Series Front Panel View	35
1.7.2 Nuvo-7200VTC Series Rear Panel View	35
1.7.3 Nuvo-7200VTC Series Top View	36
1.7.4 Nuvo-7200VTC Series Bottom View	37
1.7.5 Nuvo-7200VTC Series with Wall Mount Bracket	37
1.8 Nuvo-7250VTC Series Dimension	38
1.8.1 Nuvo-7250VTC Series Front Panel View	38
1.8.2 Nuvo-7250VTC Series Rear Panel View	38
1.8.3 Nuvo-7250VTC Series Top Panel View	39
1.8.4 Nuvo-7250VTC Series Bottom View	40
1.8.5 Nuvo-7250VTC Series with Wall Mount Bracket	40
2 System Overview	
2.1 Packing List	41
2.1.1 Nuvo-7100VTC Series Packing List	41
2.1.2 Nuvo-7200VTC Series Packing List	41
2.1.3 Nuvo-7250VTC Series Packing List	42
2.2 Nuvo-7000VTC Series Front Panel I/O	43
2.2.1 USB3.1 Gen2 Port	45
2.2.2 USB3.1 Gen1 Port	45
2.2.3 DVI Port	46
2.2.4 VGA Port	47

2.2.5	DisplayPort.....	48
2.2.6	Micro-SIM (3FF) 1 & 2 Slots.....	49
2.2.7	Ethernet Port/ PoE+	50
2.2.8	Reset Button	51
2.2.9	LED Indicators	51
2.2.10	Power Button	52
2.2.11	Hot-swappable 2.5" HDD/ SSD Slot.....	53
2.3	Nuvo-7000VTC Series Rear Panel I/O	54
2.3.1	CAN bus Port.....	56
2.3.2	M12 Power over Ethernet Port (Nuvo-7100/ 7200/ 7250VTC).....	57
2.3.3	RJ45 Power over Ethernet Port (Nuvo-7104/ 7254/ 7108/ 7258VTC).....	58
2.3.4	Digital Input/ Output	59
2.3.5	COM Ports	61
2.3.6	3-Pin Terminal Block for DC and Ignition Input.....	62
2.3.7	3-Pin Remote On/ Off	62
2.3.8	PB-2500J LED Status Indicators (Nuvo-7250VTC Series Only)	63
2.4	Internal I/O Functions.....	64
2.4.1	Clear CMOS Button	64
2.4.2	Dual SODIMM DRAM Slot.....	65
2.4.3	Dual Mode mSATA/ mini-PCIe Socket & Pin Definition.....	66
2.4.4	M.2 2242 (B Key), Mini-SIM Card Slot & Pin Definition.....	68
2.4.5	SATA Ports.....	70
2.4.6	DIP Switch	71
2.4.7	On/ Off Ctrl & Status Output.....	72
2.4.8	Internal USB 2.0 Port.....	73
2.4.9	M.2 2280 (M Key) Slot for NVMe SSD or Optane™ Memory.....	74
2.4.10	M.2 Socket on MezIO™ Module	76
2.4.11	mini-PCIe Socket on MezIO™ Module.....	78
2.4.12	Ignition Switch on MezIO™ Module (Nuvo-7100/ 7200/ 7250VTC only).....	80
2.4.13	MezIO™ Interface & Pin Definition.....	81

3 System Installation

3.1	Disassembling the System	84
3.2	Installing Internal Components.....	92
3.2.1	CPU Installation Procedure.....	92
3.2.2	DDR4 SO-DIMM Installation	98
3.2.3	mPCIe Module, Mini-SIM (2FF) Card and Antenna Installation	100
3.2.4	M.2 2242 (B Key) Module and Micro-SIM (3FF) Card Installation.....	103
3.2.5	M.2 2280 NVMe SSD or Intel® Optane™ Memory Installation.....	106
3.2.6	MezIO™ Module Installation	108
3.2.7	HDD/ SSD Installation (Nuvo-7100 VTC Series Systems).....	111
3.2.8	HDD/ SSD Installation to Hot-swappable Tray.....	114
3.2.9	Ethernet/ PoE+ Port Panel Screw Fix	116
3.2.10	PCIe Card Installation into Cassette Module (Nuvo-7200VTC)	117
3.3	PB-2500J Installation/ Replacement (Nuvo-7250VTC Series Only).....	120
3.4	Installing the System Enclosure	124
3.5	Wall Mount Bracket/ DIN-rail Installation.....	129
3.5.1	Nuvo-7100VTC Series Wall Mount Bracket Installation	129
3.5.2	Nuvo-7200/ 7250VTC Series Wall Mount Bracket Installation	131
3.5.3	DIN-rail Installation (Optional).....	132
3.6	Powering On the System	133
3.6.1	Powering On Using the Power Button.....	133
3.6.2	Powering On Using External Non-latched Switch	134
3.6.3	Powering On Using Wake-on-LAN.....	135
3.7	Ignition Power Control.....	137
3.7.1	Principles of Ignition Power Control	137
3.7.2	Additional Features of Ignition Power Control	138
3.7.3	Wiring Ignition Signal	139
3.7.4	Configure your Windows system.....	140
3.7.5	Operation Modes of Ignition Power Control	141
3.7.6	BIOS Ignition Power Control [Mode 15 (F)].....	143

4 System Configuration

4.1	BIOS Settings	147
4.1.1	COM Port Configuration	148
4.1.2	COM Port High Speed Mode	149
4.1.3	Delay for PEG Initialization	150
4.1.4	SATA Configuration	151
4.1.5	TPM Availability	153
4.1.6	Auto Wake on S5	154
4.1.7	Power On After Power Failure Option	155
4.1.8	Power & Performance (CPU SKU Power Configuration)	156
4.1.9	Wake on LAN Option	157
4.1.10	Boot Menu	158
4.1.11	Boot Type (Legacy/ UEFI)	160
4.1.12	Position New Boot Device	161
4.1.13	Watchdog Timer for Booting	162
4.1.14	Legacy/ UEFI Boot Device	163
4.2	AMT Configuration	164
4.3	RAID Configuration	165
4.3.1	Legacy Mode RAID Configuration	165
4.3.2	UEFI Mode RAID Configuration	171

5 OS Support and Driver Installation

5.1	Operating System Compatibility	181
5.2	Driver Installation	182
5.2.1	Install Drivers Automatically	182
5.2.2	Install Drivers Manually	183
5.3	Driver Installation for Watchdog Timer Control	184
5.4	Intel® Optane™ Memory BIOS Setup and Driver Installation	185

Appendix A Using WDT & DIO

WDT and DIO Library Installation	195
WDT Functions	197
InitWDT	197
SetWDT	197
StartWDT	198
ResetWDT	198
StopWDT	198
Using DIO Function	199
Wiring for DIO	199
DIO Pin Definition	200
DIO Function Reference	201
InitDIO	201
DIReadLine	201
DIReadPort	201
DOWriteLine	202
DOWritePort	202
DOWriteLineChecked	203
DOWritePortChecked	203
COS Function Reference	204
SetupDICOS	204
RegisterCallbackDICOS	205
StartDICOS	205
StopDICOS	206
DI COS Example	206

Appendix B PoE On/ Off Control

GetStatusPoEPort	209
EnablePoEPort	210
DisablePoEPort	211

Legal Information

All Neosys Technology Inc. products shall be subject to the latest Standard Warranty Policy

Neosys Technology Inc. may modify, update or upgrade the software, firmware or any accompanying user documentation without any prior notice. Neosys Technology Inc. will provide access to these new software, firmware or documentation releases from download sections of our website or through our service partners.

Before installing any software, applications or components provided by a third party, customer should ensure that they are compatible and interoperable with Neosys Technology Inc. product by checking in advance with Neosys Technology Inc.. Customer is solely responsible for ensuring the compatibility and interoperability of the third party's products. Customer is further solely responsible for ensuring its systems, software, and data are adequately backed up as a precaution against possible failures, alternation, or loss.

For questions in regards to hardware/ software compatibility, customers should contact Neosys Technology Inc. sales representative or technical support.

To the extent permitted by applicable laws, Neosys Technology Inc. shall NOT be responsible for any interoperability or compatibility issues that may arise when (1) products, software, or options not certified and supported; (2) configurations not certified and supported are used; (3) parts intended for one system is installed in another system of different make or model.

Contact Information

Headquarters
(Taipei, Taiwan)

Neosys Technology Inc.
15F, No.868-3, Zhongzheng Rd., Zhonghe Dist., New Taipei City, 23586, Taiwan
Tel: +886-2-2223-6182 Fax: +886-2-2223-6183 [Email](#), [Website](#)

Americas
(Illinois, USA)

Neosys Technology America Inc.
3384 Commercial Avenue, Northbrook, IL 60062, USA
Tel: +1-847-656-3298 [Email](#), [Website](#)

China

Neosys Technology (China) Ltd.
Room 612, Building 32, Guiping Road 680, Shanghai
Tel: +86-2161155366 [Email](#), [Website](#)

Declaration of Conformity

FCC

This equipment has been tested and found to comply with the limits for a Class A digital device, pursuant to part 15 of the FCC Rules. These limits are designed to provide reasonable protection against harmful interference when the equipment is operated in a commercial environment. This equipment generates, uses, and can radiate radio frequency energy and, if not installed and used in accordance with the instruction manual, may cause harmful interference to radio communications. Operation of this equipment in a residential area is likely to cause harmful interference in which case the user will be required to correct the interference at own expense.

CE

The product(s) described in this manual complies with all applicable European Union (CE) directives if it has a CE marking. For computer systems to remain CE compliant, only CE-compliant parts may be used. Maintaining CE compliance also requires proper cable and cabling techniques.

Copyright Notice

All rights reserved. This publication may not be reproduced, transmitted, transcribed, stored in a retrieval system, or translated into any language or computer language, in any form or by any means, electronic, mechanical, magnetic, optical, chemical, manual or otherwise, without the prior written consent of Neosys Technology, Inc.

Disclaimer

This manual is intended to be used as an informative guide only and is subject to change without prior notice. It does not represent commitment from Neosys Technology Inc. Neosys Technology Inc. shall not be liable for any direct, indirect, special, incidental, or consequential damages arising from the use of the product or documentation, nor for any infringement on third party rights.

Patents and Trademarks

Neosys, the Neosys logo, Expansion Cassette, MezIO™ are registered patents and trademarks of Neosys Technology, Inc.

Windows is a registered trademark of Microsoft Corporation.

Intel®, Core™ are registered trademarks of Intel Corporation

NVIDIA® is a registered trademark of NVIDIA Corporation

All other names, brands, products or services are trademarks or registered trademarks of their respective owners.

Safety Precautions

- Read these instructions carefully before you install, operate, or transport the system.
- Install the system or DIN rail associated with, at a sturdy location
- Install the power socket outlet near the system where it is easily accessible
- Secure each system module(s) using its retaining screws
- Place power cords and other connection cables away from foot traffic. Do not place items over power cords and make sure they do not rest against data cables
- Shutdown, disconnect all cables from the system and ground yourself before touching internal modules
- Ensure that the correct power range is being used before powering the device
- Should a module fail, arrange for a replacement as soon as possible to minimize down-time
- By means of a power cord connected to a socket-outlet with earthing connection
- This product is intended to be supplied by a Listed Power Adapter or DC power source, rated 24Vdc, 16A, Tma 60 degree C and 5000m altitude during operation. If further assistance is required, please contact Neousys Technology
- If the system is not going to be used for a long time, disconnect it from mains (power socket) to avoid transient over-voltage

Hot Surface Warning



HOT SURFACE. DO NOT TOUCH. "ATTENTION: Surface chaude. Ne pas toucher."

WARNING!

Components/ parts inside the equipment may be hot to touch!
Please wait one-half hour after switching off before handling parts.

Battery Warning

Caution!



- Batteries are at risk of exploding if incorrectly installed
- Do not attempt to recharge, force open, or heat the battery
- Replace the battery only with the same or equivalent type recommended by the manufacturer

Service and Maintenance

- ONLY qualified personnel should service the system
- Shutdown the system, disconnect the power cord and all other connections before servicing the system
- When replacing/ installing additional components (expansion card, memory module, etc.), insert them as gently as possible while assuring proper connector engagement

ESD Precautions

- Handle add-on module, motherboard by their retention screws or the module's frame/ heat sink. Avoid touching the PCB circuit board or add-on module connector pins
- Use a grounded wrist strap and an anti-static work pad to discharge static electricity when installing or maintaining the system
- Avoid dust, debris, carpets, plastic, vinyl and styrofoam in your work area.
- Do not remove any module or component from its anti-static bag before installation

Restricted Access Location

The controller is intended for installation only in the certain environment where both these condition apply:

- Access can only be gained by SERVICE PERSONS or by USERS who have been instructed about the reasons for the restrictions applied to the location and about any precautions that shall be taken
- Access is through the use of a TOOL or lock and key, or other means of security, and is controlled by the authority responsible for the location.

About This Manual

This manual introduces Neusys' in-vehicle Nuvo-7000VTC series featuring Intel® 9th/ 8th Gen Core™ I hexa-core 35W/ 65W TDP LGA1151 processors.

The guide also demonstrates the system's disassembly and installation procedures.

Revision History

Version	Date	Description
1.0	Apr. 2020	Initial release
1.1	Jul. 2020	Nuvo-7100VTC rear panel illustration update
1.2	Aug. 2020	DIO pin-out definition update Updated Nuvo-7200VTC wall mount installation
1.3	Oct. 2021	Updated DIP switch configuration
1.4	Dec. 2021	Updated "Operation Modes of Ignition Power Control" – rotary switch location
1.5	May. 2022	Updated PoE+ power delivery per port and total power budget information
1.6	Jul. 2022	Updated digital input/ output function/ reference in Appendix A
1.7	Oct. 2022	Updated DIN rail installation
1.8	Jun. 2023	Updated ignition control Mode 15 configuration

1 Introduction

Nuvo-7000VTC series are rugged in-vehicle controllers featuring purpose-built set and effortless connectivity. Powered by Intel® 9th/ 8th Gen Core™ processors with up to 8-core/ 16-thread, 64GB DDR4 memory, isolated CAN bus for in-vehicle communication, isolated DIO for sensor/ actuator control, 8~35V wide-range DC input with ignition power control and is in compliance with E-Mark and EN 50155. It is the perfect solution with extraordinary reliability for various in-vehicle applications.



Nuvo-7100VTC series

Nuvo-7200VTC is a rugged in-vehicle controller featuring Neosys' patented Cassette module with a x16 PCIe slot for add-on such as a graphics card for application-specific capability and flexibility. The system is ideal for advance in-vehicle applications.



Nuvo-7200VTC series

Nuvo-7250VTC is a rugged in-vehicle controller that utilizes Neosys' innovative supercapacitor-based power backup solution. The supercapacitor technology provides 2500 watt-second stored energy to sustain the system to safely shutdown during unforeseen power outages.



Nuvo-7250VTC series

Nuvo-7000VTC series are the latest rugged in-vehicle controllers featuring purpose-built set and effortless connectivity, powered by Intel® 8th-Gen Core™ processors with up to 6-core/ 12-thread when using 8th Gen or 8-core/ 8-thread when using 9th Gen Core CPU architecture and 64GB DDR4 memory that gets a significant performance increase over previous generations for versatile in-vehicle applications. The Nuvo-7000VTC series lineup include Nuvo-7100VTC series, Nuvo-7200VTC series and Nuvo-7250VTC series; with each system variation serving a special functionality.

Nuvo-7000VTC series offer four or eight 802.3at PoE+ ports to supply 25W power to connected devices such as IP cameras with M12 (x-coded connectors) and connector screw-lock mechanisms on computer I/Os like Gigabit Ethernet, USB3.0 and USB3.1 to guarantee extreme rugged connectivity in shock/ vibration environments. Wireless connectivity are essential for modern day in-vehicle applications and you can simultaneously utilize two M.2 and three mini-PCIe sockets with corresponding wireless

modules for 3G/ 4G, WIFI, GPS, and CAN module for communication. Additionally, there is a 4G cellular module option that is certified to work with renowned US telecommunications company which can save you implementation time and cost. On top of all that, Nuvo-7000VTC series also feature isolated CAN bus for in-vehicle communication, isolated DIO for sensor/ actuator control, 8~35V wide-range DC input with ignition power control and is in compliance with E-Mark and EN 50155. Nuvo-7100VTC is an ideal solution with extraordinary reliability for various in-vehicle application needs; Nuvo-7200VTC features dual 2.5" removable drives and Neosys' patented Cassette module with a PCIe slot for flexible in-vehicle applications; Nuvo-7250VTC utilizes Neosys' supercapacitor-based power backup solution to secure and save data from sudden power loss.

1.1 Nuvo-7100VTC Series Specifications

1.1.1 Nuvo-7100VTC Specifications

System Core	
Processor	Supporting Intel® 9th/ 8th-generation Coffee Lake CPU (LGA1151 socket, 35W TDP)* - Intel® Core™ i7-8700/ i7-8700T/ i7-9700TE - Intel® Core™ i5-8500/ i5-8500T/ i5-9500TE - Intel® Core™ i3-8100/ i3-8100T/ i3-9100TE
Chipset	Intel® Q370 Platform Controller Hub
Graphics	Integrated Intel® HD Graphics 630
Memory	Up to 64GB DDR4 2666/ 2400 SDRAM (two SODIMM slots)
AMT	Supports AMT 12.0
TPM	Supports TPM 2.0
I/O Interface	
Ethernet port	2x Gigabit Ethernet ports by I219 and I210
PoE+	4x IEEE 802.3at (25.5W per port, or 100W total power budget) Gigabit PoE+ ports (M12 x-coded) by Intel® I210
CAN	1x isolated CAN 2.0 port
Isolated DIO	4x isolated DI and 4x isolated DO
USB	4x USB 3.1 Gen2 (10Gbps) ports 4x USB 3.1 Gen1 (5Gbps) ports
Video Port	1x VGA connector, supporting 1920 x 1200 resolution 1x DVI-D connector, supporting 1920 x 1200 resolution 1x DisplayPort connector, supporting 4096 x 2304 resolution
COM Port	2x software-programmable RS-232/ 422/ 485 ports (COM1/ COM2) 2x RS-232 ports (COM3/ COM4)
Audio	1x mic-in and 1x speaker-out
Storage Interface	
SATA HDD	1x hot-swappable HDD tray for 2.5" HDD/ SSD installation 1x Internal SATA port for 2.5" HDD/ SSD installation, supporting RAID 0/1
M.2 NVMe	1x M.2 2280 M key NVMe socket (PCIe Gen3 x4) for NVMe SSD or Intel® Optane™ memory installation
mSATA	1x full-size mSATA port (mux with mini-PCIe)
Internal Expansion Bus	

Mini PCI-E	1x full-size mini PCI Express socket with internal SIM socket (mux with mSATA) 2x full-size mini-PCIe sockets (USB signals only) with internal SIM sockets
M.2	2x M.2 2242 B key socket with dual front-accessible SIM sockets supporting dual SIM mode with selected M.2 LTE module
Power Supply	
DC Input	1x 3-pin pluggable terminal block for 8~35VDC DC input
Remote Ctrl. & LED Output	1x 3-pin pluggable terminal block for remote control and PWR LED output
Maximum Power Consumption	With i7-8700T (35W mode): 72W (Max.) @ 24V With i5-8500T (35W mode): 68.4W (Max.) @ 24V With i3-8100T (35W mode): 62.64W (Max.) @ 24V
Mechanical	
Dimension	240 mm (W) x 225 mm (D) x 84 mm (H)
Weight	3.5Kg (approx.)
Mounting	Neosys' patented damping bracket (standard) or optional DIN-rail mounting
Environmental	
Operating Temperature	-40°C ~ 70°C */ **
Storage Temperature	-40°C ~ 85°C
Humidity	10%~90% , non-condensing
Vibration	Operating, MIL-STD-810G, Method 514.6, Category 4
Shock	Operating, MIL-STD-810G, Method 516.6, Procedure I, Table 516.6-II
EMC	CE/ FCC Class A, according to EN 55032 & EN 55024

When running CPUs with greater than 35W TDP, the maximum operating temperature shall be limited to 50°C and thermal throttling may occur when sustained full-load is applied. Users can configure CPU power in BIOS to obtain higher operating temperature.

*** For sub-zero operating temperature, a wide temperature HDD or Solid State Disk (SSD) is required.*

1.1.2 Nuvo-7104VTC Specifications

System Core	
Processor	Supporting Intel® 9th/ 8th-generation Coffee Lake CPU (LGA1151 socket, 35W TDP)* - Intel® Core™ i7-8700/ i7-8700T/ i7-9700TE - Intel® Core™ i5-8500/ i5-8500T/ i5-9500TE - Intel® Core™ i3-8100/ i3-8100T/ i3-9100TE
Chipset	Intel® Q370 Platform Controller Hub
Graphics	Integrated Intel® HD Graphics 630
Memory	Up to 64GB DDR4 2666/ 2400 SDRAM (two SODIMM slots)
AMT	Supports AMT 12.0
TPM	Supports TPM 2.0
I/O Interface	
Ethernet port	2x Gigabit Ethernet ports by I219 and I210
PoE+	4x IEEE 802.3at (25.5W per port, or 100W total power budget) Gigabit PoE+ ports (RJ45) by Intel® I210
CAN	1x isolated CAN 2.0 port
Isolated DIO	4x isolated DI and 4x isolated DO
USB	4x USB 3.1 Gen2 (10Gbps) ports 4x USB 3.1 Gen1 (5Gbps) ports
Video Port	1x VGA connector, supporting 1920 x 1200 resolution 1x DVI-D connector, supporting 1920 x 1200 resolution 1x DisplayPort connector, supporting 4096 x 2304 resolution
COM Port	2x software-programmable RS-232/ 422/ 485 ports (COM1/ COM2) 2x RS-232 ports (COM3/ COM4)
Audio	1x mic-in and 1x speaker-out
Storage Interface	
SATA HDD	1x hot-swappable HDD tray for 2.5" HDD/ SSD installation 1x Internal SATA port for 2.5" HDD/ SSD installation, supporting RAID 0/1
M.2 NVMe	1x M.2 2280 M key NVMe socket (PCIe Gen3 x4) for NVMe SSD or Intel® Optane™ memory installation
mSATA	1x full-size mSATA port (mux with mini-PCIe)
Internal Expansion Bus	
Mini PCI-E	1x full-size mini PCI Express socket with internal SIM socket (mux with mSATA)

	2x full-size mini-PCIe sockets (USB signals only) with internal SIM sockets
M.2	2x M.2 2242 B key socket with dual front-accessible SIM sockets supporting dual SIM mode with selected M.2 LTE module
Power Supply	
DC Input	1x 3-pin pluggable terminal block for 8~35VDC DC input
Remote Ctrl. & LED Output	1x 3-pin pluggable terminal block for remote control and PWR LED output
Maximum Power Consumption	With i7-8700T (35W mode): 72W (Max.) @ 24V With i5-8500T (35W mode): 68.4W (Max.) @ 24V With i3-8100T (35W mode): 62.64W (Max.) @ 24V
Mechanical	
Dimension	240 mm (W) x 225 mm (D) x 84 mm (H)
Weight	3.5Kg (approx.)
Mounting	Neosys' patented damping bracket (standard) or optional DIN-rail mounting
Environmental	
Operating Temperature	-40°C ~ 70°C * / **
Storage Temperature	-40°C ~ 85°C
Humidity	10%~90% , non-condensing
Vibration	Operating, MIL-STD-810G, Method 514.6, Category 4
Shock	Operating, MIL-STD-810G, Method 516.6, Procedure I, Table 516.6-II
EMC	CE/ FCC Class A, according to EN 55032 & EN 55024

** When running CPUs with greater than 35W TDP, the maximum operating temperature shall be limited to 50°C and thermal throttling may occur when sustained full-load is applied. Users can configure CPU power in BIOS to obtain higher operating temperature.*

*** For sub-zero operating temperature, a wide temperature HDD or Solid State Disk (SSD) is required.*

1.1.3 Nuvo-7108VTC Specifications

System Core	
Processor	Supporting Intel® 9th/ 8th-generation Coffee Lake CPU (LGA1151 socket, 35W TDP)* - Intel® Core™ i7-8700/ i7-8700T/ i7-9700TE - Intel® Core™ i5-8500/ i5-8500T/ i5-9500TE - Intel® Core™ i3-8100/ i3-8100T/ i3-9100TE
Chipset	Intel® Q370 Platform Controller Hub
Graphics	Integrated Intel® HD Graphics 630
Memory	Up to 64GB DDR4 2666/ 2400 SDRAM (two SODIMM slots)
AMT	Supports AMT 12.0
TPM	Supports TPM 2.0
I/O Interface	
Ethernet port	2x Gigabit Ethernet ports by I219 and I210
PoE+	8x IEEE 802.3at (25.5W per port, or 100W total power budget) Gigabit PoE+ ports (RJ45) by Intel® I210
CAN	1x isolated CAN 2.0 port
Isolated DIO	4x isolated DI and 4x isolated DO
USB	4x USB 3.1 Gen2 (10Gbps) ports 4x USB 3.1 Gen1 (5Gbps) ports
Video Port	1x VGA connector, supporting 1920 x 1200 resolution 1x DVI-D connector, supporting 1920 x 1200 resolution 1x DisplayPort connector, supporting 4096 x 2304 resolution
COM Port	2x software-programmable RS-232/ 422/ 485 ports (COM1/ COM2) 2x RS-232 ports (COM3/ COM4)
Audio	1x mic-in and 1x speaker-out
Storage Interface	
SATA HDD	1x hot-swappable HDD tray for 2.5" HDD/ SSD installation 1x Internal SATA port for 2.5" HDD/ SSD installation, supporting RAID 0/1
M.2 NVMe	1x M.2 2280 M key NVMe socket (PCIe Gen3 x4) for NVMe SSD or Intel® Optane™ memory installation
mSATA	1x full-size mSATA port (mux with mini-PCIe)
Internal Expansion Bus	
Mini PCI-E	1x full-size mini PCI Express socket with internal SIM socket (mux with mSATA)

	2x full-size mini-PCIe sockets (USB signals only) with internal SIM sockets
M.2	2x M.2 2242 B key socket with dual front-accessible SIM sockets supporting dual SIM mode with selected M.2 LTE module
Power Supply	
DC Input	1x 3-pin pluggable terminal block for 8~35VDC DC input
Remote Ctrl. & LED Output	1x 3-pin pluggable terminal block for remote control and PWR LED output
Maximum Power Consumption	With i7-8700T (35W mode): 72W (Max.) @ 24V With i5-8500T (35W mode): 68.4W (Max.) @ 24V With i3-8100T (35W mode): 62.64W (Max.) @ 24V
Mechanical	
Dimension	240 mm (W) x 225 mm (D) x 84 mm (H)
Weight	3.5Kg (approx.)
Mounting	Neosys' patented damping bracket (standard) or optional DIN-rail mounting
Environmental	
Operating Temperature	-40°C ~ 70°C * / **
Storage Temperature	-40°C ~ 85°C
Humidity	10%~90% , non-condensing
Vibration	Operating, MIL-STD-810G, Method 514.6, Category 4
Shock	Operating, MIL-STD-810G, Method 516.6, Procedure I, Table 516.6-II
EMC	CE/ FCC Class A, according to EN 55032 & EN 55024

** When running CPUs with greater than 35W TDP, the maximum operating temperature shall be limited to 50°C and thermal throttling may occur when sustained full-load is applied. Users can configure CPU power in BIOS to obtain higher operating temperature.*

*** For sub-zero operating temperature, a wide temperature HDD or Solid State Disk (SSD) is required.*

1.2 Nuvo-7200VTC Series Specifications

1.2.1 Nuvo-7200VTC Specifications

System Core	
Processor	Supporting Intel® 9th/ 8th-generation Coffee Lake CPU (LGA1151 socket, 35W TDP)* - Intel® Core™ i7-8700/ i7-8700T/ i7-9700TE - Intel® Core™ i5-8500/ i5-8500T/ i5-9500TE - Intel® Core™ i3-8100/ i3-8100T/ i3-9100TE
Chipset	Intel® Q370 Platform Controller Hub
Graphics	Integrated Intel® HD Graphics 630
Memory	Up to 64GB DDR4 2666/ 2400 SDRAM (two SODIMM slots)
AMT	Supports AMT 12.0
TPM	Supports TPM 2.0
I/O Interface	
Ethernet port	2x Gigabit Ethernet ports by I219 and I210
PoE+	4x IEEE 802.3at (25.5W per port, or 100W total power budget) Gigabit PoE+ ports (M12 x-coded) by Intel® I210
CAN	1x isolated CAN 2.0 port
Isolated DIO	4x isolated DI and 4x isolated DO
USB	4x USB 3.1 Gen2 (10Gbps) ports 4x USB 3.1 Gen1 (5Gbps) ports
Video Port	1x VGA connector, supporting 1920 x 1200 resolution 1x DVI-D connector, supporting 1920 x 1200 resolution 1x DisplayPort connector, supporting 4096 x 2304 resolution
COM Port	2x software-programmable RS-232/ 422/ 485 ports (COM1/ COM2) 2x RS-232 ports (COM3/ COM4)
Audio	1x mic-in and 1x speaker-out
Storage Interface	
SATA HDD	1x hot-swappable HDD tray for 2.5" HDD/ SSD installation 1x Internal SATA port for 2.5" HDD/ SSD installation, supporting RAID 0/1
M.2 NVMe	1x M.2 2280 M key NVMe socket (PCIe Gen3 x4) for NVMe SSD or Intel® Optane™ memory installation
mSATA	1x full-size mSATA port (mux with mini-PCIe)
Internal Expansion Bus	

PCI Express	1x PCIe x16 slot@Gen3, 16-lanes PCIe signal in Cassette
Mini PCI-E	1x full-size mini PCI Express socket with internal SIM socket (mux with mSATA) 2x full-size mini-PCIe sockets (USB signals only) with internal SIM sockets
M.2	2x M.2 2242 B key socket with dual front-accessible SIM sockets supporting dual SIM mode with selected M.2 LTE module
Power Supply	
DC Input	1x 3-pin pluggable terminal block for 8~35VDC DC input
Remote Ctrl. & LED Output	1x 3-pin pluggable terminal block for remote control and PWR LED output
Maximum Power Consumption	With i7-8700T (35W mode): 72W (Max.) @ 24V With i5-8500T (35W mode): 68.4W (Max.) @ 24V With i3-8100T (35W mode): 62.64W (Max.) @ 24V
Mechanical	
Dimension	240 mm (W) x 225 mm (D) x 103 mm (H)
Weight	3.5Kg (approx.)
Mounting	Neosys' patented damping bracket (standard) or optional DIN-rail mounting
Environmental	
Operating Temperature	-40°C ~ 70°C */ **
Storage Temperature	-40°C ~ 85°C
Humidity	10%~90% , non-condensing
Vibration	Operating, MIL-STD-810G, Method 514.6, Category 4
Shock	Operating, MIL-STD-810G, Method 516.6, Procedure I, Table 516.6-II
EMC	CE/ FCC Class A, according to EN 55032 & EN 55024

** When running CPUs with greater than 35W TDP, the maximum operating temperature shall be limited to 50°C and thermal throttling may occur when sustained full-load is applied. Users can configure CPU power in BIOS to obtain higher operating temperature.*

*** For sub-zero operating temperature, a wide temperature HDD or Solid State Disk (SSD) is required.*

1.2.2 Nuvo-7204VTC Specifications

System Core	
Processor	Supporting Intel® 9th/ 8th-generation Coffee Lake CPU (LGA1151 socket, 35W TDP)* - Intel® Core™ i7-8700/ i7-8700T/ i7-9700TE - Intel® Core™ i5-8500/ i5-8500T/ i5-9500TE - Intel® Core™ i3-8100/ i3-8100T/ i3-9100TE
Chipset	Intel® Q370 Platform Controller Hub
Graphics	Integrated Intel® HD Graphics 630
Memory	Up to 64GB DDR4 2666/ 2400 SDRAM (two SODIMM slots)
AMT	Supports AMT 12.0
TPM	Supports TPM 2.0
I/O Interface	
Ethernet port	2x Gigabit Ethernet ports by I219 and I210
PoE+	4x IEEE 802.3at (25.5W per port, or 100W total power budget) Gigabit PoE+ ports (RJ45) by Intel® I210
CAN	1x isolated CAN 2.0 port
Isolated DIO	4x isolated DI and 4x isolated DO
USB	4x USB 3.1 Gen2 (10Gbps) ports 4x USB 3.1 Gen1 (5Gbps) ports
Video Port	1x VGA connector, supporting 1920 x 1200 resolution 1x DVI-D connector, supporting 1920 x 1200 resolution 1x DisplayPort connector, supporting 4096 x 2304 resolution
COM Port	2x software-programmable RS-232/ 422/ 485 ports (COM1/ COM2) 2x RS-232 ports (COM3/ COM4)
Audio	1x mic-in and 1x speaker-out
Storage Interface	
SATA HDD	1x hot-swappable HDD tray for 2.5" HDD/ SSD installation 1x Internal SATA port for 2.5" HDD/ SSD installation, supporting RAID 0/1
M.2 NVMe	1x M.2 2280 M key NVMe socket (PCIe Gen3 x4) for NVMe SSD or Intel® Optane™ memory installation
mSATA	1x full-size mSATA port (mux with mini-PCIe)
Internal Expansion Bus	
PCI Express	1x PCIe x16 slot@Gen3, 16-lanes PCIe signal in Cassette
Mini PCI-E	1x full-size mini PCI Express socket with internal SIM socket (mux with

	mSATA) 2x full-size mini-PCIe sockets (USB signals only) with internal SIM sockets
M.2	2x M.2 2242 B key socket with dual front-accessible SIM sockets supporting dual SIM mode with selected M.2 LTE module
Power Supply	
DC Input	1x 3-pin pluggable terminal block for 8~35VDC DC input
Remote Ctrl. & LED Output	1x 3-pin pluggable terminal block for remote control and PWR LED output
Maximum Power Consumption	With i7-8700T (35W mode): 72W (Max.) @ 24V With i5-8500T (35W mode): 68.4W (Max.) @ 24V With i3-8100T (35W mode): 62.64W (Max.) @ 24V
Mechanical	
Dimension	240 mm (W) x 225 mm (D) x 103 mm (H)
Weight	3.5Kg (approx.)
Mounting	Neosys' patented damping bracket (standard) or optional DIN-rail mounting
Environmental	
Operating Temperature	-40°C ~ 70°C */ **
Storage Temperature	-40°C ~ 85°C
Humidity	10%~90% , non-condensing
Vibration	Operating, MIL-STD-810G, Method 514.6, Category 4
Shock	Operating, MIL-STD-810G, Method 516.6, Procedure I, Table 516.6-II
EMC	CE/ FCC Class A, according to EN 55032 & EN 55024

** When running CPUs with greater than 35W TDP, the maximum operating temperature shall be limited to 50°C and thermal throttling may occur when sustained full-load is applied. Users can configure CPU power in BIOS to obtain higher operating temperature.*

*** For sub-zero operating temperature, a wide temperature HDD or Solid State Disk (SSD) is required.*

1.2.3 Nuvo-7208VTC Specifications

System Core	
Processor	Supporting Intel® 9th/ 8th-generation Coffee Lake CPU (LGA1151 socket, 35W TDP)* - Intel® Core™ i7-8700/ i7-8700T/ i7-9700TE - Intel® Core™ i5-8500/ i5-8500T/ i5-9500TE - Intel® Core™ i3-8100/ i3-8100T/ i3-9100TE
Chipset	Intel® Q370 Platform Controller Hub
Graphics	Integrated Intel® HD Graphics 630
Memory	Up to 64GB DDR4 2666/ 2400 SDRAM (two SODIMM slots)
AMT	Supports AMT 12.0
TPM	Supports TPM 2.0
I/O Interface	
Ethernet port	2x Gigabit Ethernet ports by I219 and I210
PoE+	8x IEEE 802.3at (25.5W per port, or 100W total power budget) Gigabit PoE+ ports (RJ45) by Intel® I210
CAN	1x isolated CAN 2.0 port
Isolated DIO	4x isolated DI and 4x isolated DO
USB	4x USB 3.1 Gen2 (10Gbps) ports 4x USB 3.1 Gen1 (5Gbps) ports
Video Port	1x VGA connector, supporting 1920 x 1200 resolution 1x DVI-D connector, supporting 1920 x 1200 resolution 1x DisplayPort connector, supporting 4096 x 2304 resolution
COM Port	2x software-programmable RS-232/ 422/ 485 ports (COM1/ COM2) 2x RS-232 ports (COM3/ COM4)
Audio	1x mic-in and 1x speaker-out
Storage Interface	
SATA HDD	1x hot-swappable HDD tray for 2.5" HDD/ SSD installation 1x Internal SATA port for 2.5" HDD/ SSD installation, supporting RAID 0/1
M.2 NVMe	1x M.2 2280 M key NVMe socket (PCIe Gen3 x4) for NVMe SSD or Intel® Optane™ memory installation
mSATA	1x full-size mSATA port (mux with mini-PCIe)
Internal Expansion Bus	
PCI Express	1x PCIe x16 slot@Gen3, 16-lanes PCIe signal in Cassette
Mini PCI-E	1x full-size mini PCI Express socket with internal SIM socket (mux with

	mSATA) 2x full-size mini-PCIe sockets (USB signals only) with internal SIM sockets
M.2	2x M.2 2242 B key socket with dual front-accessible SIM sockets supporting dual SIM mode with selected M.2 LTE module
Power Supply	
DC Input	1x 3-pin pluggable terminal block for 8~35VDC DC input
Remote Ctrl. & LED Output	1x 3-pin pluggable terminal block for remote control and PWR LED output
Maximum Power Consumption	With i7-8700T (35W mode): 72W (Max.) @ 24V With i5-8500T (35W mode): 68.4W (Max.) @ 24V With i3-8100T (35W mode): 62.64W (Max.) @ 24V
Mechanical	
Dimension	240 mm (W) x 225 mm (D) x 103 mm (H)
Weight	3.5Kg (approx.)
Mounting	Neosys' patented damping bracket (standard) or optional DIN-rail mounting
Environmental	
Operating Temperature	-40°C ~ 70°C */ **
Storage Temperature	-40°C ~ 85°C
Humidity	10%~90% , non-condensing
Vibration	Operating, MIL-STD-810G, Method 514.6, Category 4
Shock	Operating, MIL-STD-810G, Method 516.6, Procedure I, Table 516.6-II
EMC	CE/ FCC Class A, according to EN 55032 & EN 55024

** When running CPUs with greater than 35W TDP, the maximum operating temperature shall be limited to 50°C and thermal throttling may occur when sustained full-load is applied. Users can configure CPU power in BIOS to obtain higher operating temperature.*

*** For sub-zero operating temperature, a wide temperature HDD or Solid State Disk (SSD) is required.*

1.3 Nuvo-7250VTC Series Specifications

1.3.1 Nuvo-7250VTC Specifications

System Core	
Processor	Supporting Intel® 9th/ 8th-generation Coffee Lake CPU (LGA1151 socket, 35W TDP)* - Intel® Core™ i7-8700/ i7-8700T/ i7-9700TE - Intel® Core™ i5-8500/ i5-8500T/ i5-9500TE - Intel® Core™ i3-8100/ i3-8100T/ i3-9100TE
Chipset	Intel® Q370 Platform Controller Hub
Graphics	Integrated Intel® HD Graphics 630
Memory	Up to 64GB DDR4 2666/ 2400 SDRAM (two SODIMM slots)
AMT	Supports AMT 12.0
TPM	Supports TPM 2.0
I/O Interface	
Ethernet port	2x Gigabit Ethernet ports by I219 and I210
PoE+	4x IEEE 802.3at (25.5W per port, or 100W total power budget) Gigabit PoE+ ports (M12 x-coded) by Intel® I210
CAN	1x isolated CAN 2.0 port
Isolated DIO	4x isolated DI and 4x isolated DO
USB	4x USB 3.1 Gen2 (10Gbps) ports 4x USB 3.1 Gen1 (5Gbps) ports
Video Port	1x VGA connector, supporting 1920 x 1200 resolution 1x DVI-D connector, supporting 1920 x 1200 resolution 1x DisplayPort connector, supporting 4096 x 2304 resolution
COM Port	2x software-programmable RS-232/ 422/ 485 ports (COM1/ COM2) 2x RS-232 ports (COM3/ COM4)
Audio	1x mic-in and 1x speaker-out
Storage Interface	
SATA HDD	1x hot-swappable HDD tray for 2.5" HDD/ SSD installation 1x Internal SATA port for 2.5" HDD/ SSD installation, supporting RAID 0/1
M.2 NVMe	1x M.2 2280 M key NVMe socket (PCIe Gen3 x4) for NVMe SSD or Intel® Optane™ memory installation
mSATA	1x full-size mSATA port (mux with mini-PCIe)
Internal Expansion Bus	

Mini PCI-E	1x full-size mini PCI Express socket with internal SIM socket (mux with mSATA) 2x full-size mini-PCIe sockets (USB signals only) with internal SIM sockets
M.2	2x M.2 2242 B key socket with dual front-accessible SIM sockets supporting dual SIM mode with selected M.2 LTE module
Power Supply	
DC Input	1x 3-pin pluggable terminal block for 8~35VDC DC input
Remote Ctrl. & LED Output	1x 3-pin pluggable terminal block for remote control and PWR LED output
Maximum Power Consumption	With i7-8700T (35W mode): 72W (Max.) @ 24V With i5-8500T (35W mode): 68.4W (Max.) @ 24V With i3-8100T (35W mode): 62.64W (Max.) @ 24V
Power Backup	
Capacity	2500 watt-second
Mechanical	
Dimension	240 mm (W) x 225 mm (D) x 103 mm (H)
Weight	3.5Kg (approx.)
Mounting	Neosys' patented damping bracket (standard) or optional DIN-rail mounting
Environmental	
Operating Temperature	-40°C ~ 70°C * / **
Storage Temperature	-40°C ~ 85°C
Humidity	10%~90% , non-condensing
Vibration	Operating, MIL-STD-810G, Method 514.6, Category 4
Shock	Operating, MIL-STD-810G, Method 516.6, Procedure I, Table 516.6-II
EMC	CE/ FCC Class A, according to EN 55032 & EN 55024

* When running CPUs with greater than 35W TDP, the maximum operating temperature shall be limited to 50°C and thermal throttling may occur when sustained full-load is applied. Users can configure CPU power in BIOS to obtain higher operating temperature.

** For sub-zero operating temperature, a wide temperature HDD or Solid State Disk (SSD) is required.

1.3.2 Nuvo-7254VTC Specifications

System Core	
Processor	Supporting Intel® 9th/ 8th-generation Coffee Lake CPU (LGA1151 socket, 35W TDP) - Intel® Core™ i7-8700*/ i7-8700T/ i7-9700TE - Intel® Core™ i5-8500/ i5-8500T/ i5-9500TE - Intel® Core™ i3-8100/ i3-8100T/ i3-9100TE
Chipset	Intel® Q370 Platform Controller Hub
Graphics	Integrated Intel® HD Graphics 630
Memory	Up to 64GB DDR4 2666/ 2400 SDRAM (two SODIMM slots)
AMT	Supports AMT 12.0
TPM	Supports TPM 2.0
I/O Interface	
Ethernet port	2x Gigabit Ethernet ports by I219 and I210
PoE+	4x IEEE 802.3at (25.5W per port, or 100W total power budget) Gigabit PoE+ ports (RJ45) by Intel® I210
CAN	1x isolated CAN 2.0 port
Isolated DIO	4x isolated DI and 4x isolated DO
USB	4x USB 3.1 Gen2 (10Gbps) ports 4x USB 3.1 Gen1 (5Gbps) ports
Video Port	1x VGA connector, supporting 1920 x 1200 resolution 1x DVI-D connector, supporting 1920 x 1200 resolution 1x DisplayPort connector, supporting 4096 x 2304 resolution
COM Port	2x software-programmable RS-232/ 422/ 485 ports (COM1/ COM2) 2x RS-232 ports (COM3/ COM4)
Audio	1x mic-in and 1x speaker-out
Storage Interface	
SATA HDD	1x hot-swappable HDD tray for 2.5" HDD/ SSD installation 1x Internal SATA port for 2.5" HDD/ SSD installation, supporting RAID 0/1
M.2 NVMe	1x M.2 2280 M key NVMe socket (PCIe Gen3 x4) for NVMe SSD or Intel® Optane™ memory installation
mSATA	1x full-size mSATA port (mux with mini-PCIe)
Internal Expansion Bus	
Mini PCI-E	1x full-size mini PCI Express socket with internal SIM socket (mux with mSATA)

	2x full-size mini-PCIe sockets (USB signals only) with internal SIM sockets
M.2	2x M.2 2242 B key socket with dual front-accessible SIM sockets supporting dual SIM mode with selected M.2 LTE module
Power Supply	
DC Input	1x 3-pin pluggable terminal block for 8~35VDC DC input
Remote Ctrl. & LED Output	1x 3-pin pluggable terminal block for remote control and PWR LED output
Maximum Power Consumption	With i7-8700T (35W mode): 72W (Max.) @ 24V With i5-8500T (35W mode): 68.4W (Max.) @ 24V With i3-8100T (35W mode): 62.64W (Max.) @ 24V
Power Backup	
Capacity	2500 watt-second
Mechanical	
Dimension	240 mm (W) x 225 mm (D) x 103 mm (H)
Weight	3.5Kg (approx.)
Mounting	Neosys' patented damping bracket (standard) or optional DIN-rail mounting
Environmental	
Operating Temperature	-40°C ~ 70°C * / **
Storage Temperature	-40°C ~ 85°C
Humidity	10%~90% , non-condensing
Vibration	Operating, MIL-STD-810G, Method 514.6, Category 4
Shock	Operating, MIL-STD-810G, Method 516.6, Procedure I, Table 516.6-II
EMC	CE/ FCC Class A, according to EN 55032 & EN 55024

* When running CPUs with greater than 35W TDP, the maximum operating temperature shall be limited to 50°C and thermal throttling may occur when sustained full-load is applied. Users can configure CPU power in BIOS to obtain higher operating temperature.

** For sub-zero operating temperature, a wide temperature HDD or Solid State Disk (SSD) is required.

1.3.3 Nuvo-7258VTC Specifications

System Core	
Processor	Supporting Intel® 9th/ 8th-generation Coffee Lake CPU (LGA1151 socket, 35W TDP) - Intel® Core™ i7-8700*/ i7-8700T/ i7-9700TE - Intel® Core™ i5-8500/ i5-8500T/ i5-9500TE - Intel® Core™ i3-8100/ i3-8100T/ i3-9100TE
Chipset	Intel® Q370 Platform Controller Hub
Graphics	Integrated Intel® HD Graphics 630
Memory	Up to 64GB DDR4 2666/ 2400 SDRAM (two SODIMM slots)
AMT	Supports AMT 12.0
TPM	Supports TPM 2.0
I/O Interface	
Ethernet port	2x Gigabit Ethernet ports by I219 and I210
PoE+	8x IEEE 802.3at (25.5W per port, or 100W total power budget) Gigabit PoE+ ports (RJ45) by Intel® I210
CAN	1x isolated CAN 2.0 port
Isolated DIO	4x isolated DI and 4x isolated DO
USB	4x USB 3.1 Gen2 (10Gbps) ports 4x USB 3.1 Gen1 (5Gbps) ports
Video Port	1x VGA connector, supporting 1920 x 1200 resolution 1x DVI-D connector, supporting 1920 x 1200 resolution 1x DisplayPort connector, supporting 4096 x 2304 resolution
COM Port	2x software-programmable RS-232/ 422/ 485 ports (COM1/ COM2) 2x RS-232 ports (COM3/ COM4)
Audio	1x mic-in and 1x speaker-out
Storage Interface	
SATA HDD	1x hot-swappable HDD tray for 2.5" HDD/ SSD installation 1x Internal SATA port for 2.5" HDD/ SSD installation, supporting RAID 0/1
M.2 NVMe	1x M.2 2280 M key NVMe socket (PCIe Gen3 x4) for NVMe SSD or Intel® Optane™ memory installation
mSATA	1x full-size mSATA port (mux with mini-PCIe)
Internal Expansion Bus	
Mini PCI-E	1x full-size mini PCI Express socket with internal SIM socket (mux with mSATA)

	2x full-size mini-PCIe sockets (USB signals only) with internal SIM sockets
M.2	2x M.2 2242 B key socket with dual front-accessible SIM sockets supporting dual SIM mode with selected M.2 LTE module
Power Supply	
DC Input	1x 3-pin pluggable terminal block for 8~35VDC DC input
Remote Ctrl. & LED Output	1x 3-pin pluggable terminal block for remote control and PWR LED output
Maximum Power Consumption	With i7-8700T (35W mode): 72W (Max.) @ 24V With i5-8500T (35W mode): 68.4W (Max.) @ 24V With i3-8100T (35W mode): 62.64W (Max.) @ 24V
Power Backup	
Capacity	2500 watt-second
Mechanical	
Dimension	240 mm (W) x 225 mm (D) x 103 mm (H)
Weight	3.5Kg (approx.)
Mounting	Neosys' patented damping bracket (standard) or optional DIN-rail mounting
Environmental	
Operating Temperature	-40°C ~ 70°C */ **
Storage Temperature	-40°C ~ 85°C
Humidity	10%~90% , non-condensing
Vibration	Operating, MIL-STD-810G, Method 514.6, Category 4
Shock	Operating, MIL-STD-810G, Method 516.6, Procedure I, Table 516.6-II
EMC	CE/ FCC Class A, according to EN 55032 & EN 55024

** When running CPUs with greater than 35W TDP, the maximum operating temperature shall be limited to 50°C and thermal throttling may occur when sustained full-load is applied. Users can configure CPU power in BIOS to obtain higher operating temperature.*

*** For sub-zero operating temperature, a wide temperature HDD or Solid State Disk (SSD) is required.*

1.4 Isolated DIO Specifications

Isolated Digital Input	
No. of Channel	4-CH Isolated Digital Input Channels
Logic Level	Logic High: 5 to 24V Logic Low: 0 to 1.5V
Isolated Voltage	2500 Vrms
Input Resistance	1kΩ
Operation Mode	Polling I/O, Change-of-State Interrupt
Isolated Digital Output	
No. of Channel	4-CH Isolated Digital Output Channels
Sink Current (per channel)	100 mA (sustained loading) 250 mA (peak loading)
Isolated Voltage	2500 Vrms
Operation Mode	Polling, Change-of-State Interrupt
Output Type	Power MOSFET + Analog Device iCoupler®
Operation Mode	Polling I/O and Change-of-State interrupt for DI

1.5 Supported CPUs

Nuvo-7000VTC series accepts Intel® 9th/ 8th Gen. i7/ i5/ i3 processor via the LGA1151 CPU socket. Nuvo-7000VTC series support

- Intel® Core™ i7-8700/ i7-8700T/ i7-9700E/ i7-9700TE
- Intel® Core™ i5-8500/ i5-8500T/ i5-9500E/ i5-9500TE
- Intel® Core™ i3-8100/ i3-8100T/ i3-9100E/ i3-9100TE



NOTE

Other processors may result in different overall system power consumption or generate excess heat.

Avoid using CPUs that have not been tested by Neousys Technology, as Neousys Technology may not be able guarantee the system's stability and functionality under its designated working environment.

If in doubt, please contact Neousys technical support!

1.6 Nuvo-7100VTC Series Dimension



NOTE

All measurements are in millimeters (mm).

1.6.1 Nuvo-7100VTC Series Front Panel View

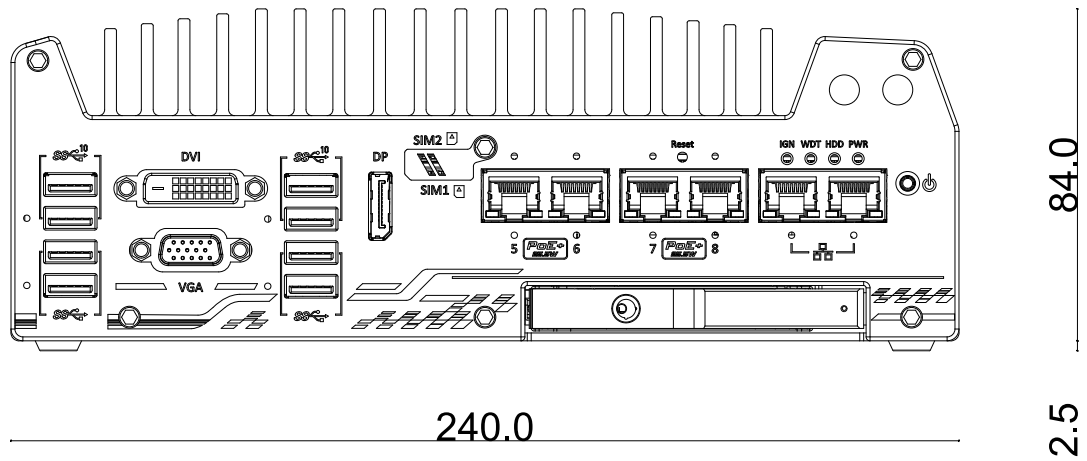

1.6.2 Nuvo-7100VTC Series Rear Panel View

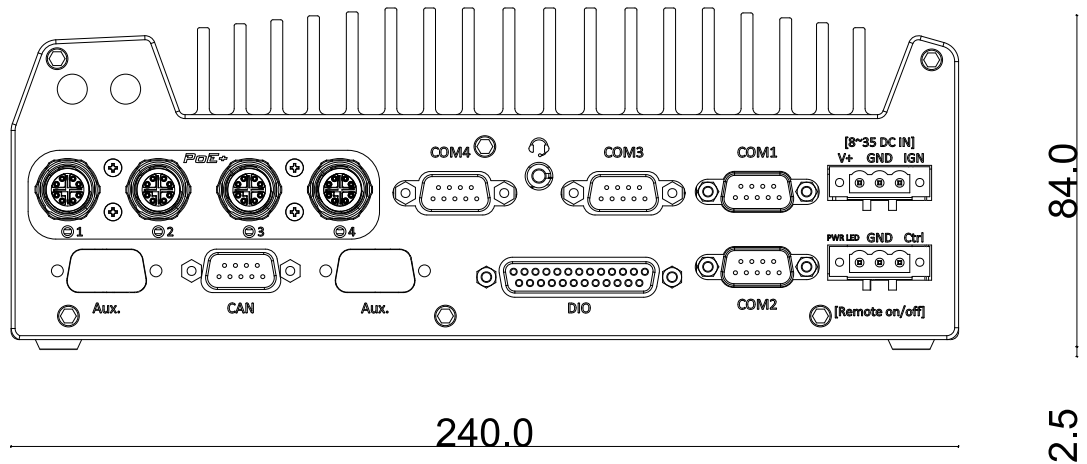

1.6.3 Nuvo-7100VTC Series Top View

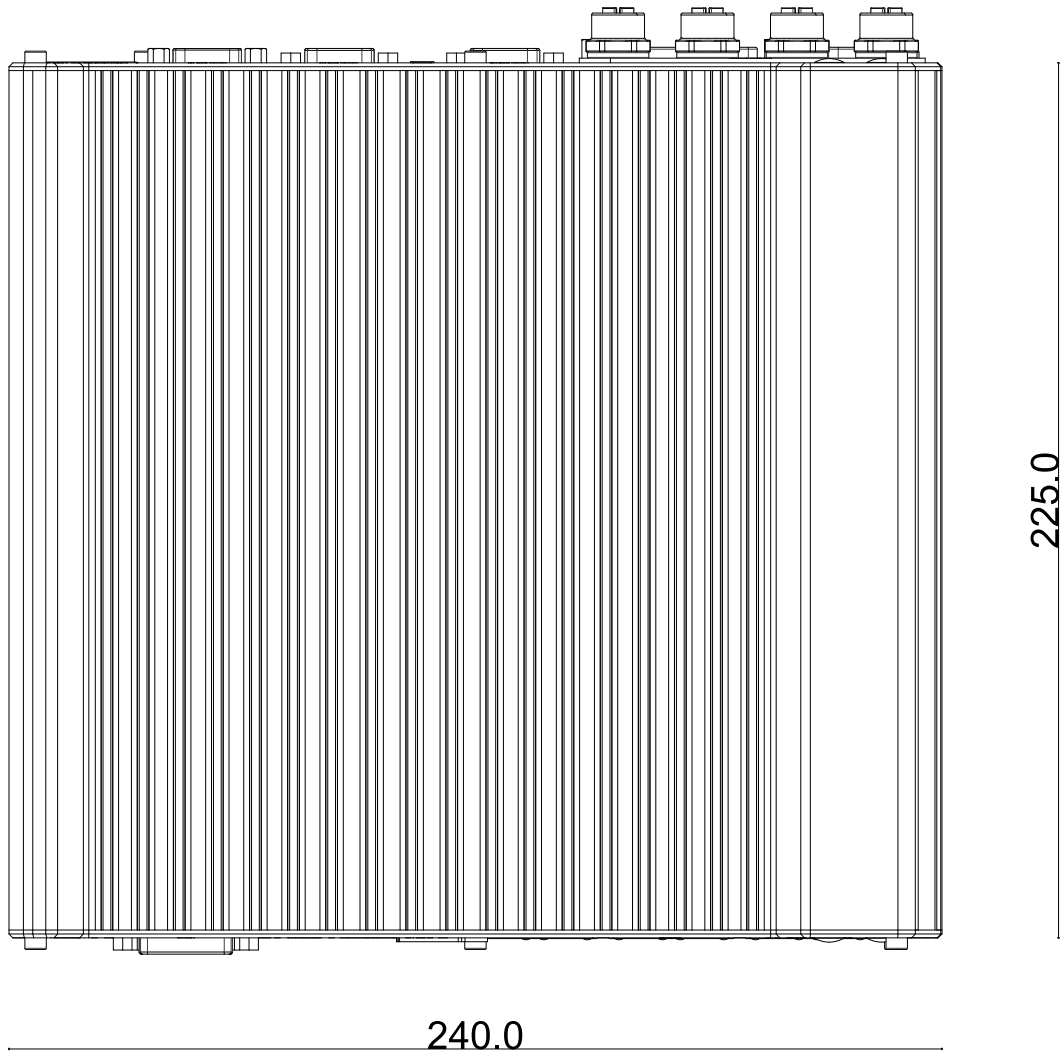

1.6.4 Nuvo-7100VTC Series Bottom View

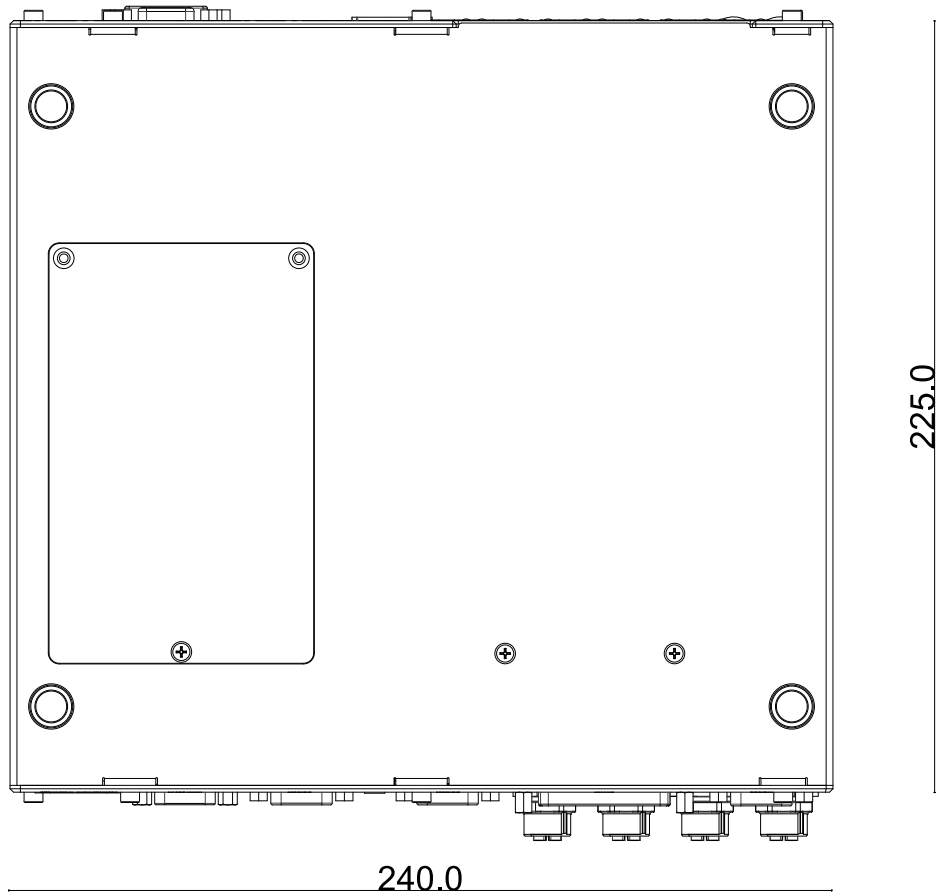

1.6.5 Nuvo-7100VTC Series with Wall Mount Bracket

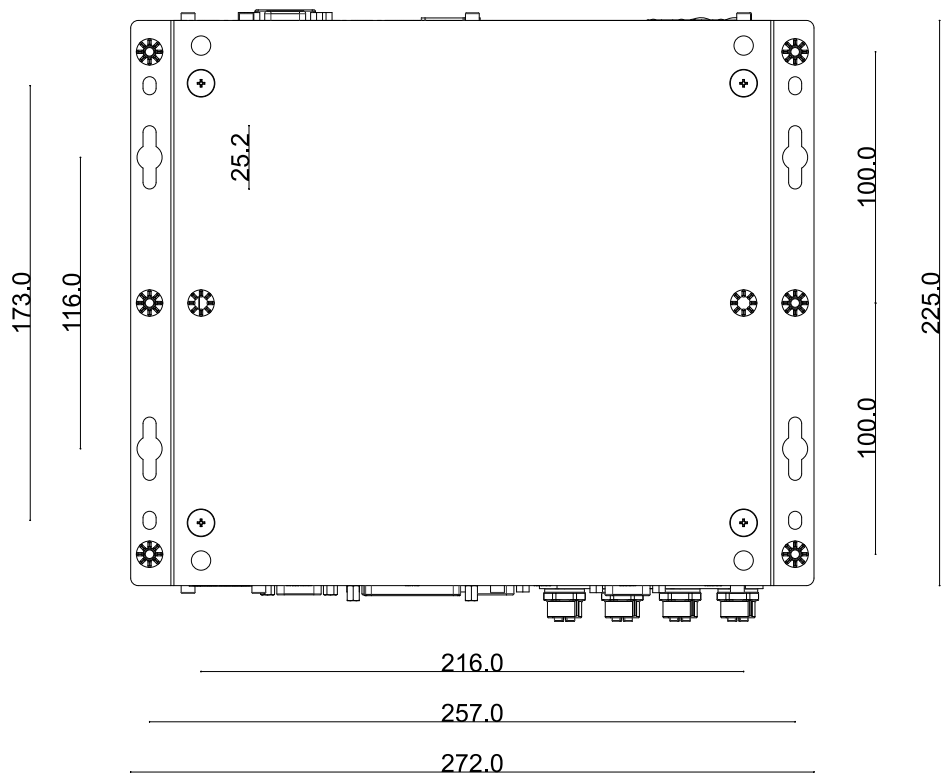

1.7 Nuvo-7200VTC Series Dimension

 **NOTE**

All measurements are in millimeters (mm).

1.7.1 Nuvo-7200VTC Series Front Panel View

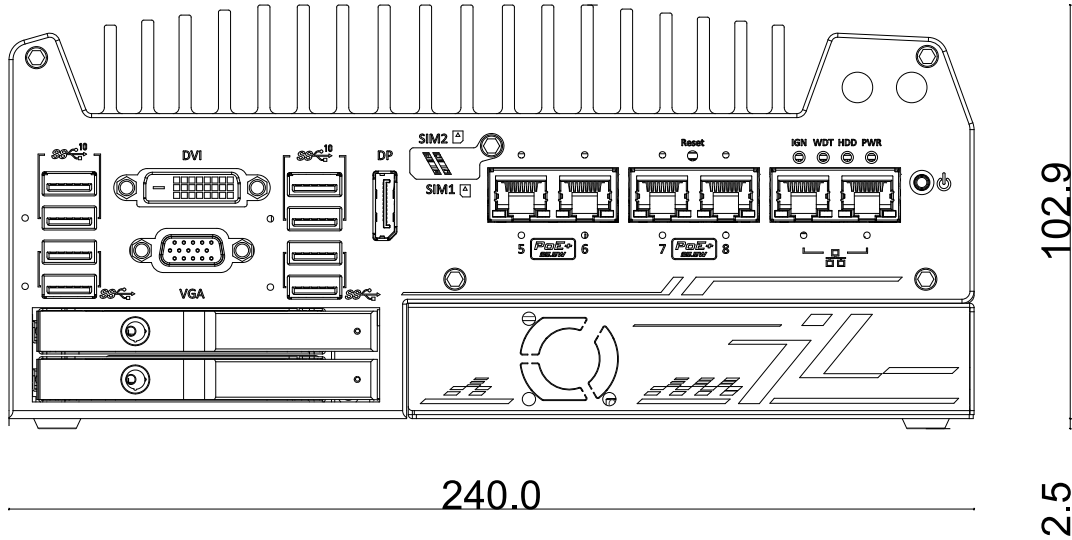

1.7.2 Nuvo-7200VTC Series Rear Panel View

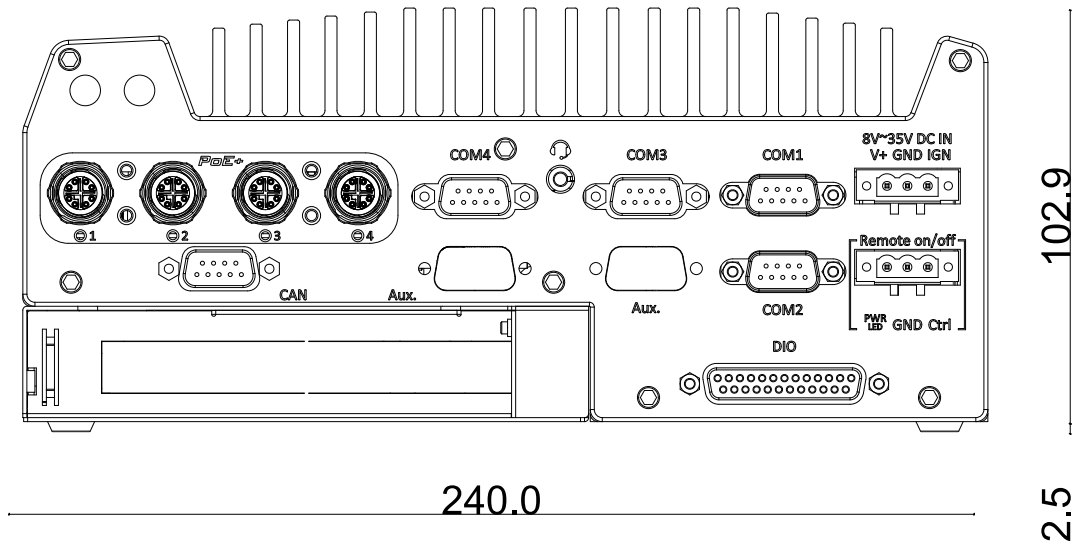

1.7.3 Nuvo-7200VTC Series Top View

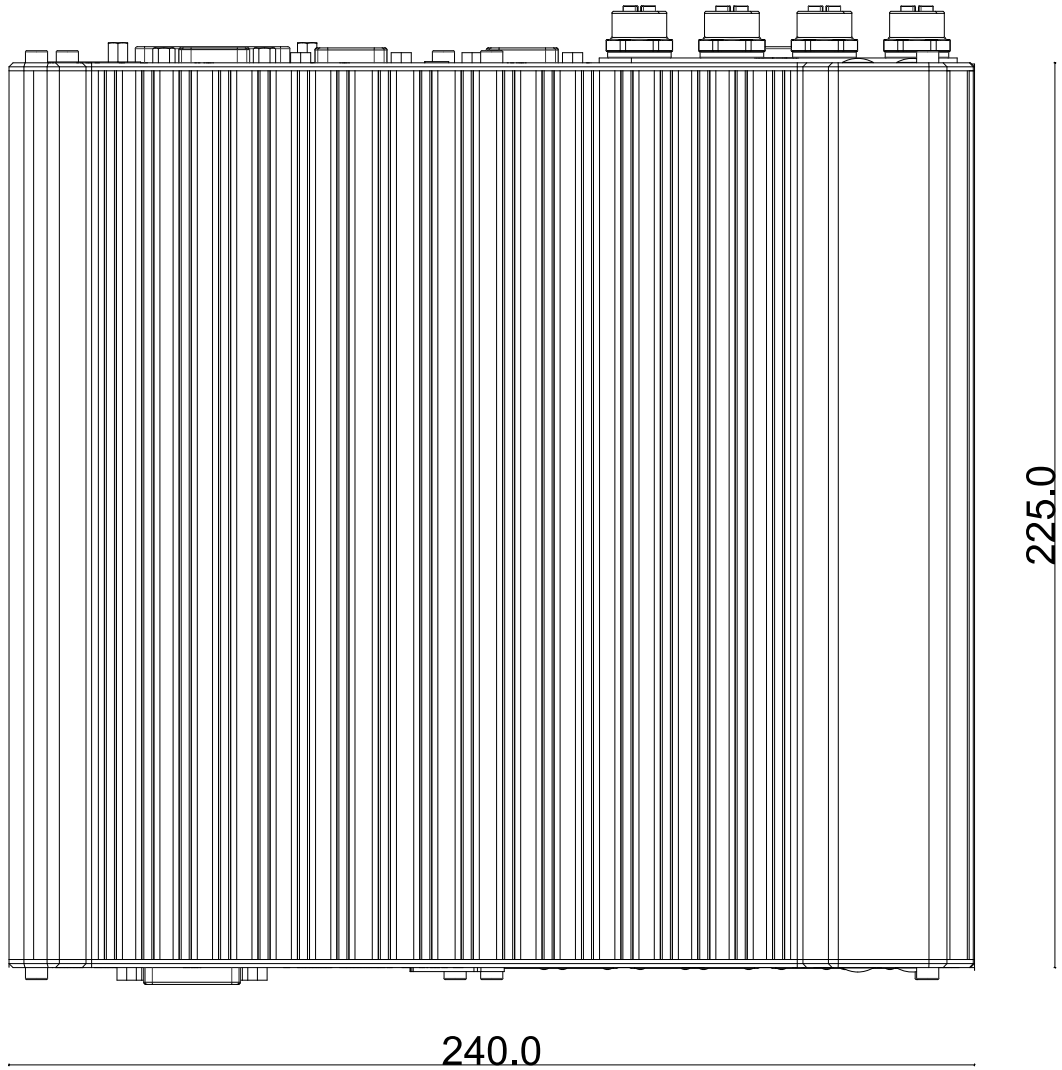

1.7.4 Nuvo-7200VTC Series Bottom View

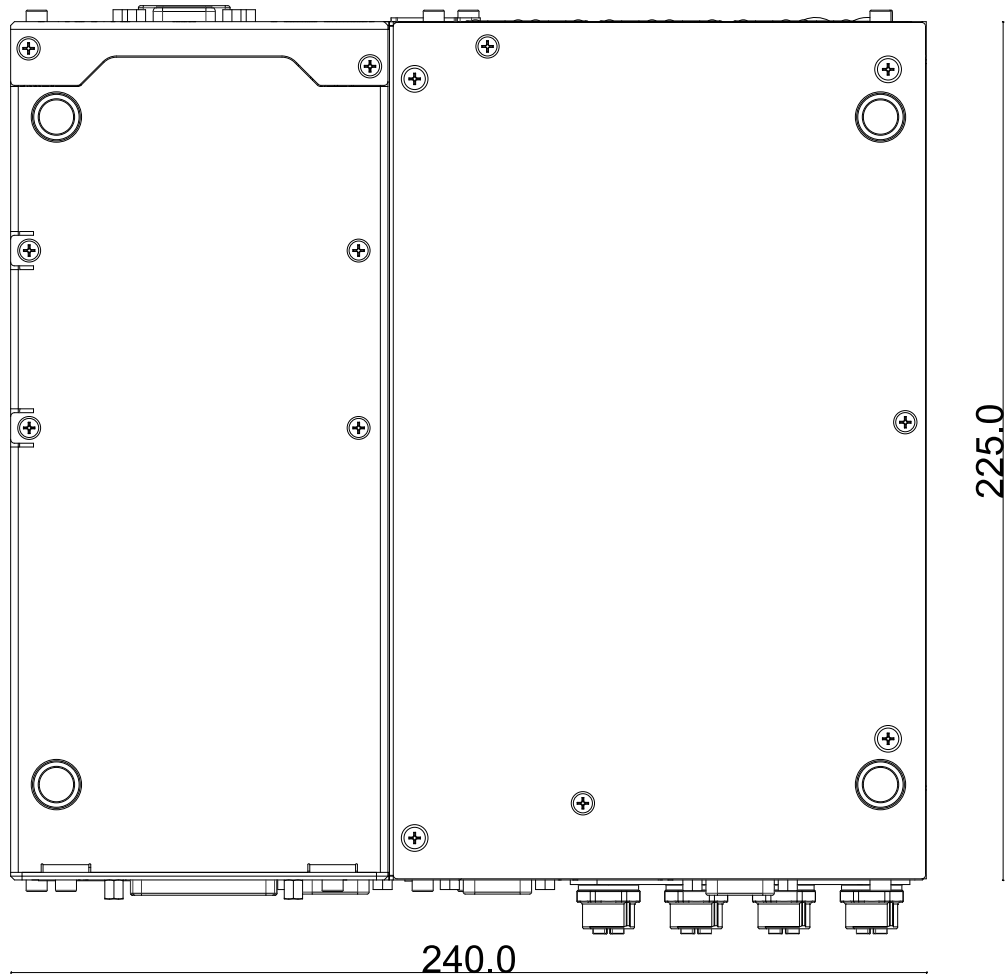

1.7.5 Nuvo-7200VTC Series with Wall Mount Bracket

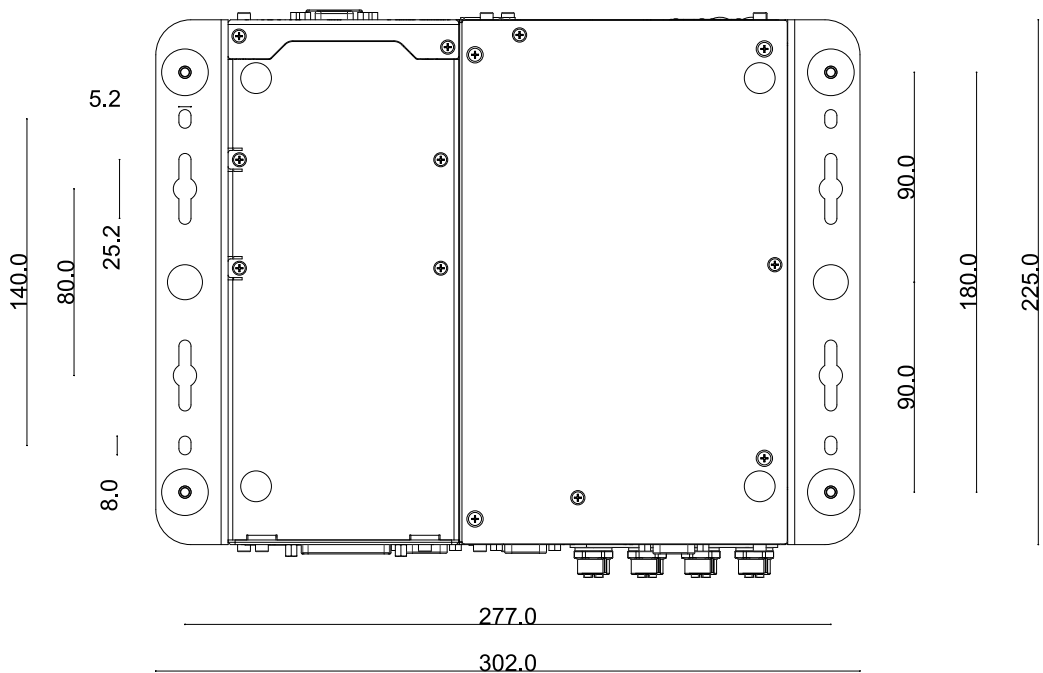

1.8 Nuvo-7250VTC Series Dimension



NOTE

All measurements are in millimeters (mm).

1.8.1 Nuvo-7250VTC Series Front Panel View

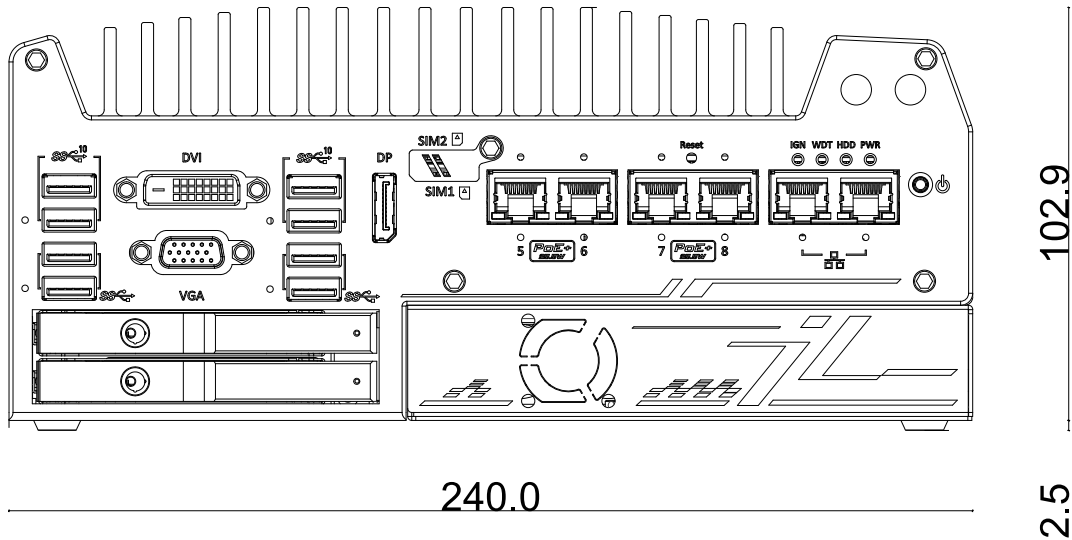

1.8.2 Nuvo-7250VTC Series Rear Panel View

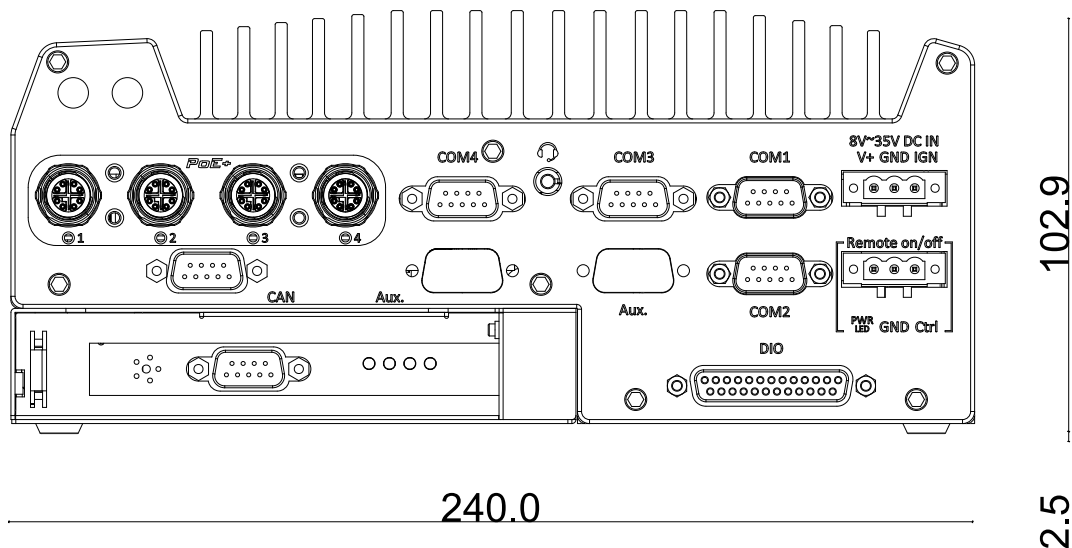

1.8.3 Nuvo-7250VTC Series Top Panel View

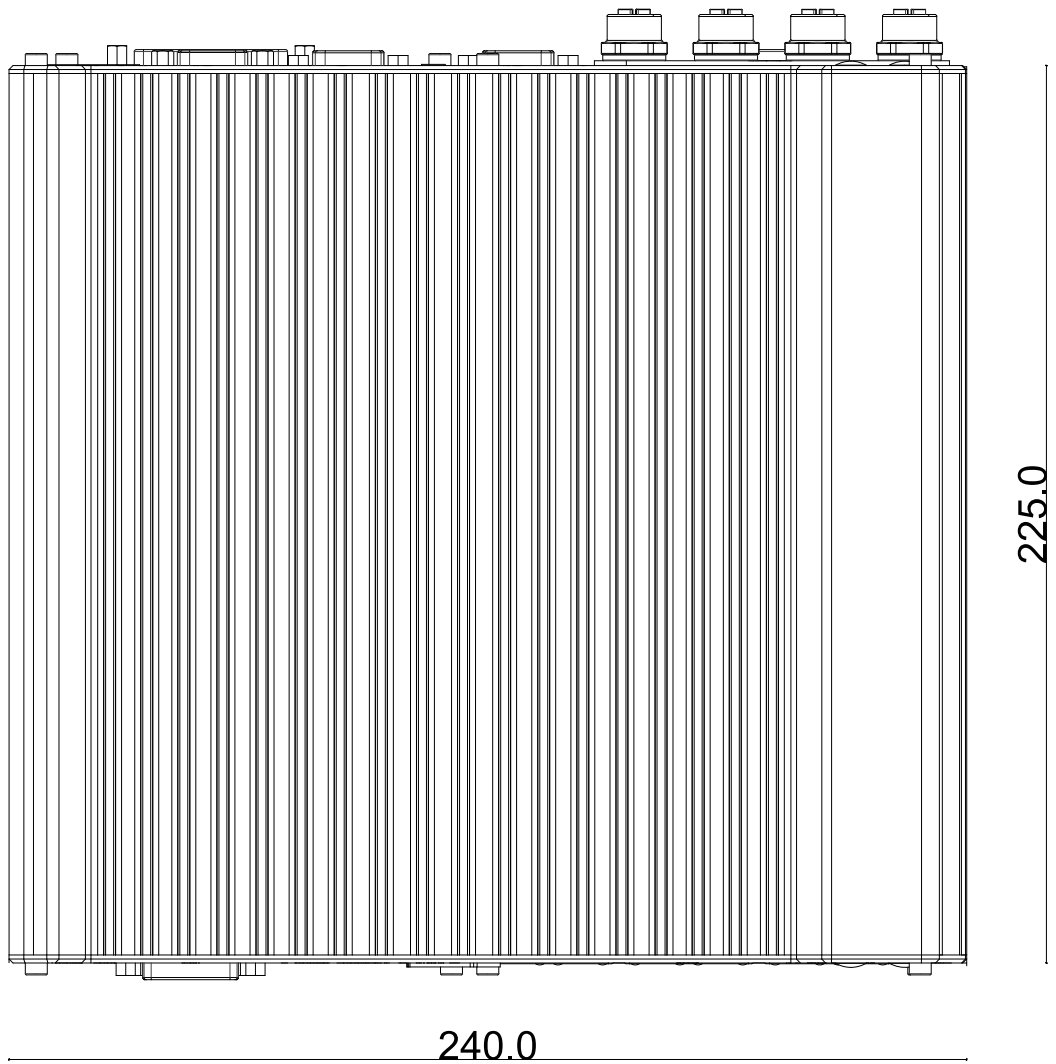

1.8.4 Nuvo-7250VTC Series Bottom View

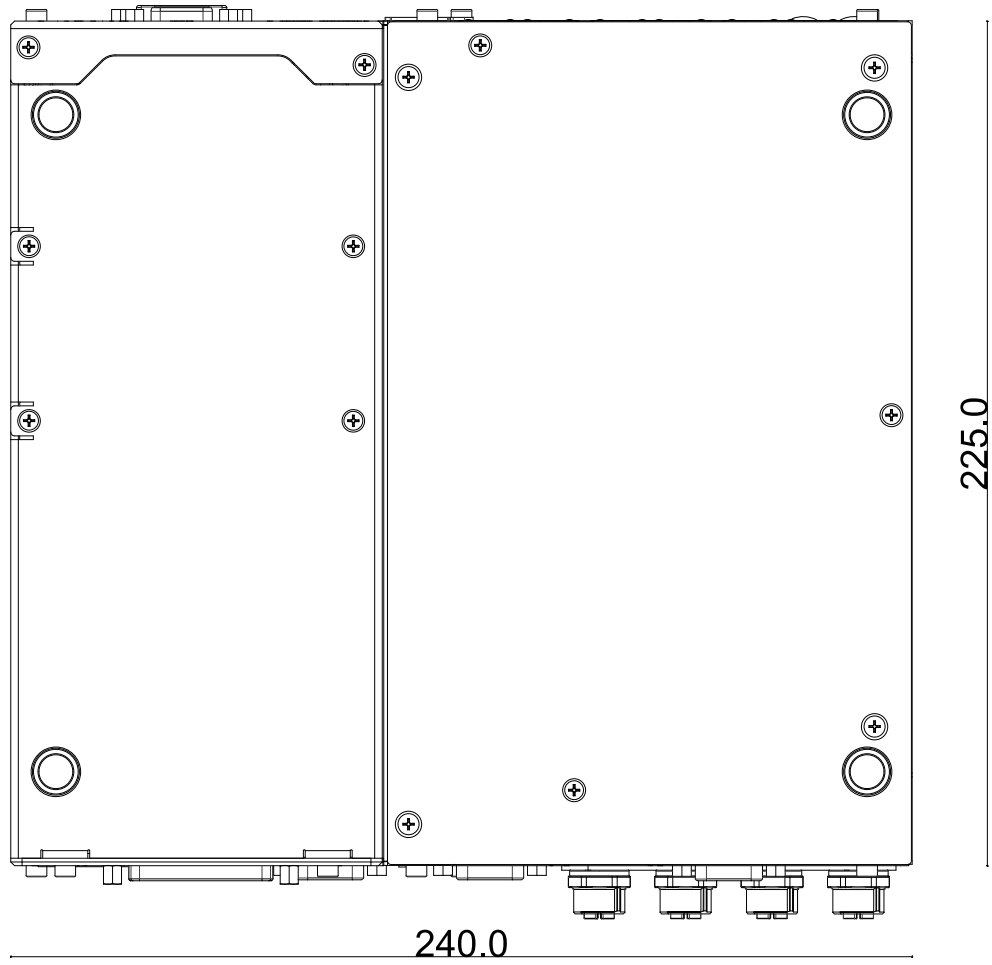

1.8.5 Nuvo-7250VTC Series with Wall Mount Bracket

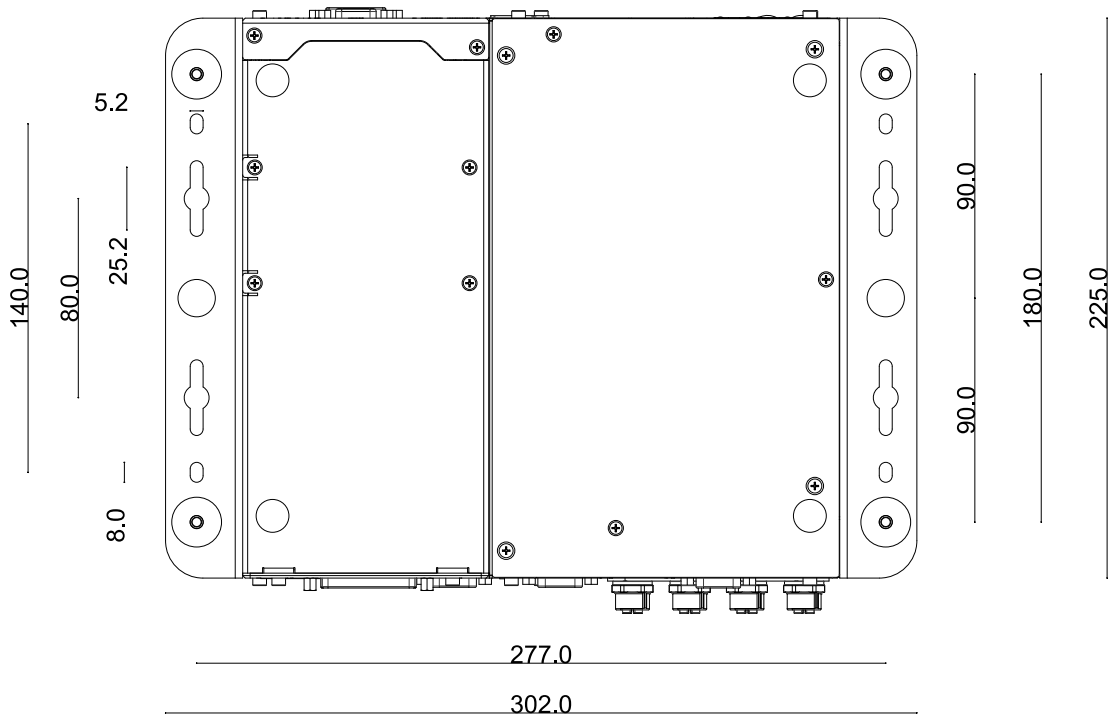

2 System Overview

Upon receiving and unpacking your Nuvo-7100VTC system, please check immediately if the package contains all the items listed in the following table. If any item(s) are missing or damaged, please contact your local dealer or Neosys Technology.

2.1 Packing List

2.1.1 Nuvo-7100VTC Series Packing List

System Pack	Nuvo-7100VTC	Nuvo-7104VTC	Nuvo-7108VTC	Qty
1	Fanless in-vehicle controller/ computer (If you ordered CPU/ RAM/ HDD, please verify these items)			1
2	Accessory box, which contains <ul style="list-style-type: none"> ● CPU bracket ● Neosys drivers & utilities DVD ● Damping bracket for in-vehicle deployment (with shock-absorbing grommets) ● 3-pin power terminal block ● Key for hot-swappable HDD tray ● HDD thermal pad for 2.5" HDD/SSD (if HDD is not installed) ● Screw pack 			1 1 1 1 1 1

2.1.2 Nuvo-7200VTC Series Packing List

System Pack	Nuvo-7200VTC	Nuvo-7204VTC	Nuvo-7208VTC	Qty
1	Fanless in-vehicle controller/ computer (If you ordered CPU/ RAM/ HDD, please verify these items)			1
2	Accessory box, which contains <ul style="list-style-type: none"> ● CPU bracket ● Neosys drivers & utilities DVD ● Damping bracket for in-vehicle deployment (with shock-absorbing grommets) ● 3-pin power terminal block ● Key for hot-swappable HDD tray ● HDD thermal pad for 2.5" HDD/SSD (if HDD is not installed) ● Screw pack 			1 1 1 1 1 1

2.1.3 Nuvo-7250VTC Series Packing List

System Pack	Nuvo-7250VTC	Nuvo-7254VTC	Nuvo-7258VTC	Qty
1	Fanless in-vehicle controller/ computer (If you ordered CPU/ RAM/ HDD, please verify these items)			1
2	Accessory box, which contains <ul style="list-style-type: none"> ● CPU bracket ● Neosys drivers & utilities DVD ● Damping bracket for in-vehicle deployment (with shock-absorbing grommets) ● 3-pin power terminal block ● Key for hot-swappable HDD tray ● HDD thermal pad for 2.5" HDD/SSD (if HDD is not installed) ● Screw pack 			1 1 1 1 1 1 1

2.2 Nuvo-7000VTC Series Front Panel I/O

Neosys Nuvo-7000VTC series front panel offer a variety of I/O ports. For demonstration purposes, Nuvo-7100VTC series will be used in most illustrations.

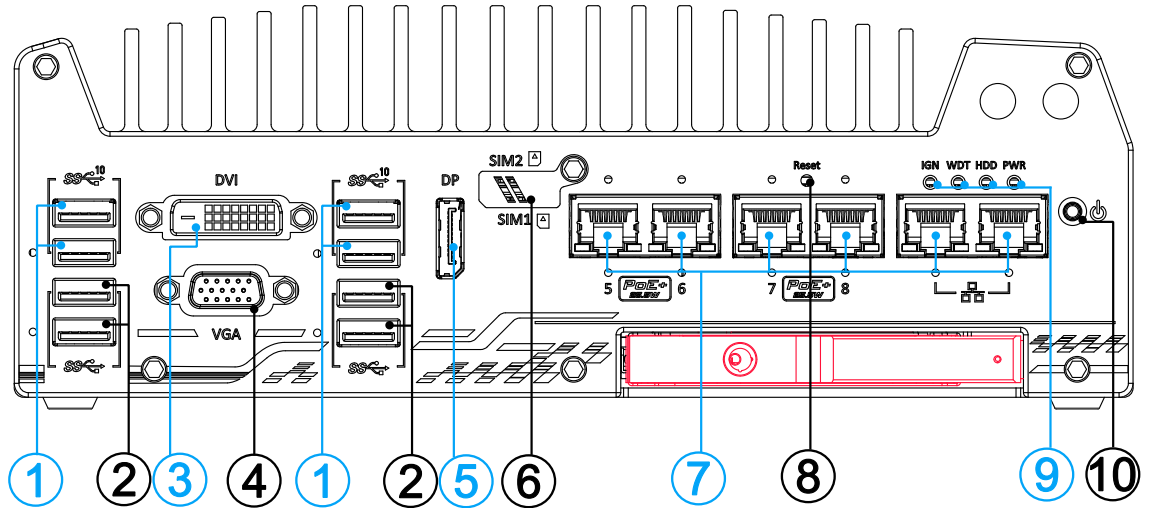

Nuvo-7100VTC Series Front Panel

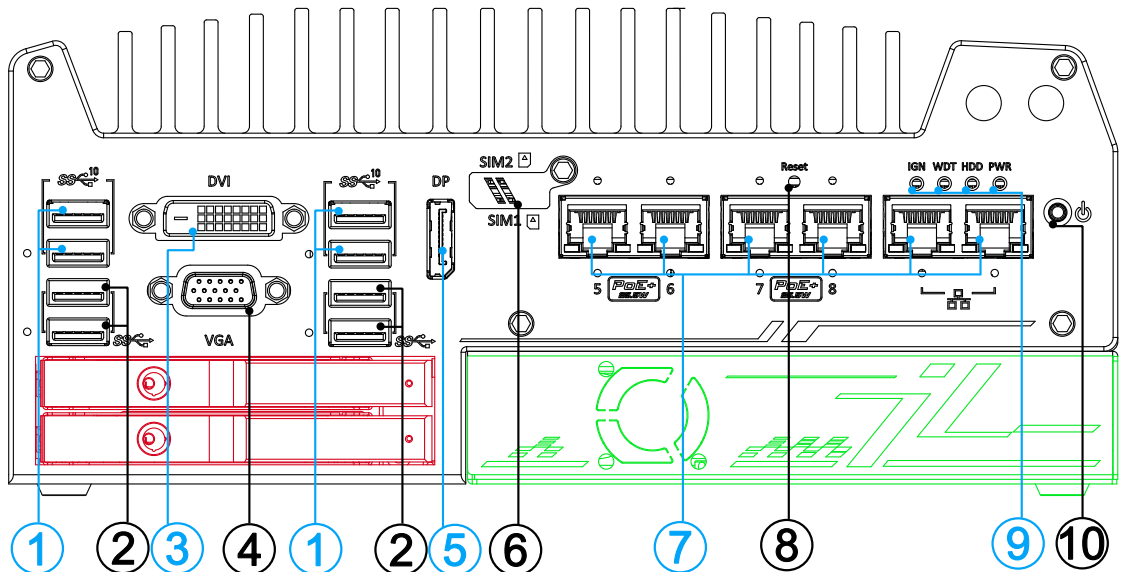

Nuvo-7200/ 7250VTC Series Front Panel

No.	Item	Description
1	USB3.1 Gen2 port	USB3.1 Gen2 port (SuperSpeed+) offers up to 10Gbps, twice the bandwidth over existing SuperSpeed USB3.1 Gen1 connection. It is also backwards compatible with USB3.0 and USB2.0
2	USB3.1 Gen1 port	USB3.1 Gen1 offers up to 5Gbps of data-throughput performance
3	DVI port	DVI-D output supports resolution up to 1920x1200@60Hz and is compatible with other digital connections via an adapter.
4	VGA port	VGA output supports resolution up to 1920x1200@60Hz

5	DisplayPort	Support display resolutions up to 4096 x 2304. Compatible with HDMI/ DVI via respective adapter/ cable (resolution may vary).
6	SIM 1 & 2	Install a 3G/ 4G module and insert a SIM card to access the operator's network.
7	PoE+ GbE port	Gigabit Ethernet ports implemented via Intel I219 and I210 chipsets. The number of ports available may vary, please refer to the specification section for more details.
8	Reset button	Use this button to manually reset the system.
9	LED indicators	From left to right, the LEDs are IGN (ignition control), WDT (watchdog timer), HDD (hard disk drive) and PWR (system power).
10	Power button	Use this button to turn on or shutdown the system.
Area in red	2.5" HDD/ SSD slot	The HDD expansion tray offer hot-swap ability. Nuvo-7200VTC and Nuvo-7250VTC each come with two front panel hot-swap slots.
Area in green	Cassette Module	The cassette enclosure offers a separate compartment to manage thermal conditions and reduce installation complications of an add-on card.

2.2.1 USB3.1 Gen2 Port

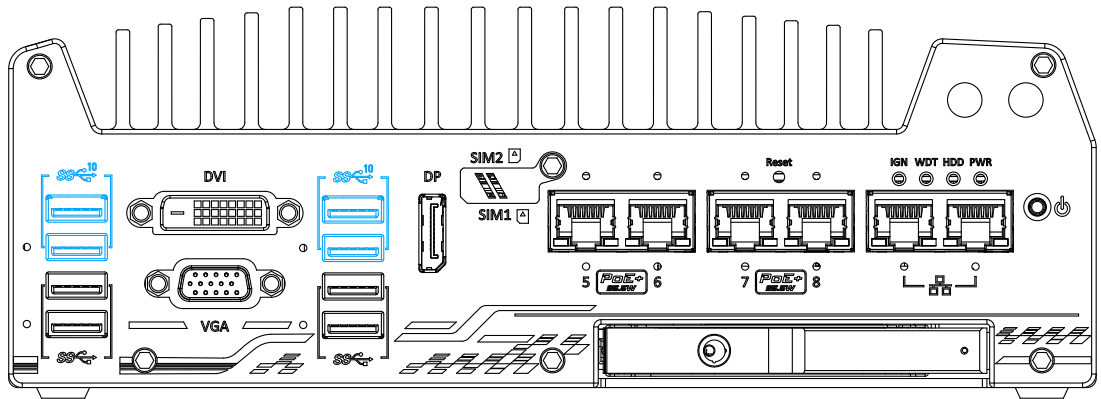

The system's USB 3.1 Gen 2 ports (10Gbps) are implemented via native xHCI (eXtensible Host Controller Interface) controller and are backward compatible with USB3.1 Gen.1 USB 2.0, USB 1.1 and USB 1.0 devices. Legacy USB is also supported so you can use USB keyboard/ mouse in DOS environment

xHCI driver is supported natively in Windows 10, therefore you do not need to install the xHCI driver prior to utilizing USB functions.

2.2.2 USB3.1 Gen1 Port

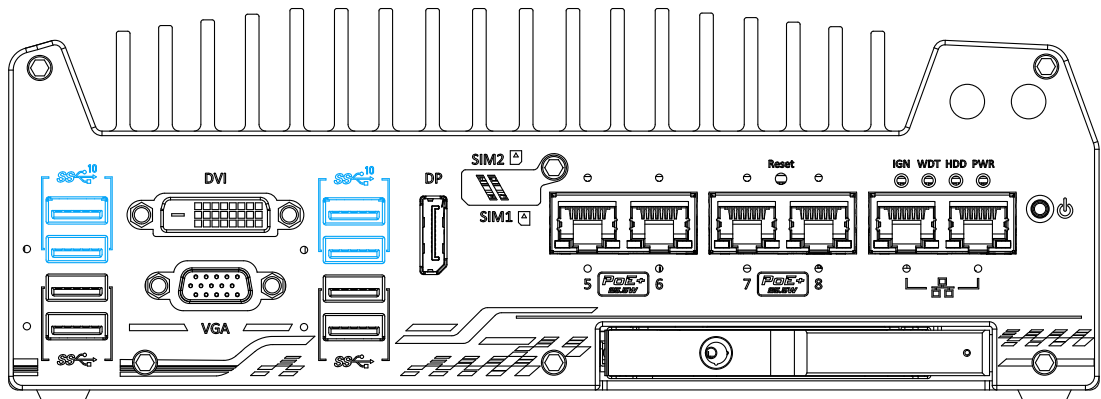

The system's USB 3.0 Gen 1 ports (5Gbps) are implemented via native xHCI (eXtensible Host Controller Interface) controller and are backward compatible with USB 2.0, USB 1.1 and USB 1.0 devices. Legacy USB is also supported so you can use USB keyboard/mouse in DOS environment

xHCI driver is supported natively in Windows 10, therefore you do not need to install the xHCI driver prior to utilizing USB functions.

2.2.3 DVI Port

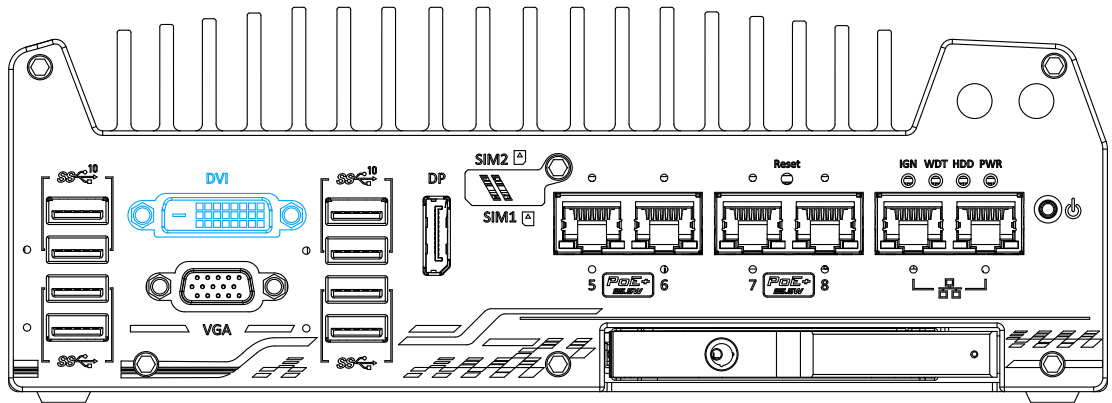

DVI-D transmits graphics data in digital format and therefore can deliver better image quality at high resolution. The DVI connector on the front panel can either output DVI signals or other digital signals (via an adapter/ cable) depending on the display device connected. It supports resolutions up to 1920x1200@60Hz.

The system supports triple independent display outputs by connecting display devices to VGA, DVI and DisplayPort connection. To support multiple display outputs and achieve best DVI output resolution in Windows, you need to install corresponding graphics driver. Please refer to section [OS Support and Driver Installation](#) for details.

2.2.4 VGA Port

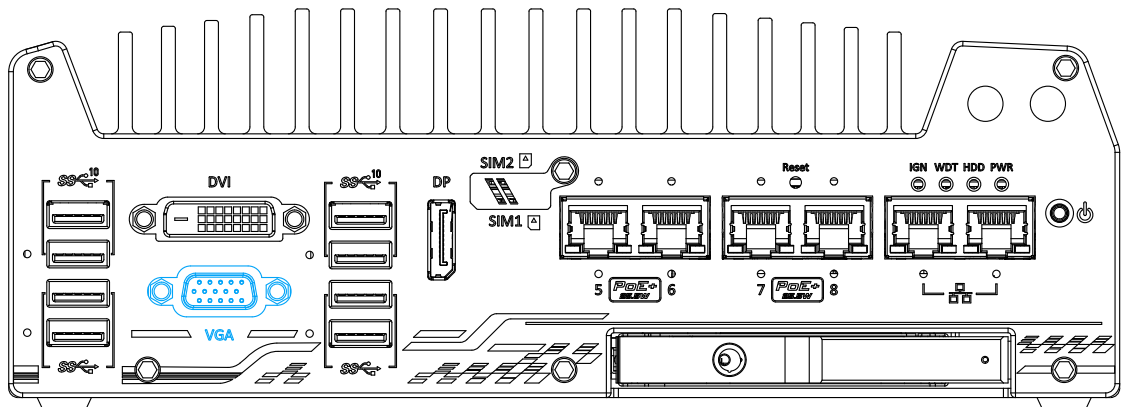

VGA connector is the most common video display connection. The VGA output supports up to 1920x1200@60Hz resolution.

The system supports triple independent display outputs by connecting display devices to VGA, DVI and DisplayPort connection. To support multiple display outputs and achieve best VGA output resolution in Windows, you need to install corresponding graphics drivers. Please refer to section [OS Support and Driver Installation](#) for details.



NOTE

Please make sure your VGA cable includes SDA and SCL (DDC clock and data) signals for correct communication with monitor to get resolution/timing information. A cable without SDA/ SCL can cause blank screen on your VGA monitor due to incorrect resolution/timing output.

2.2.5 DisplayPort

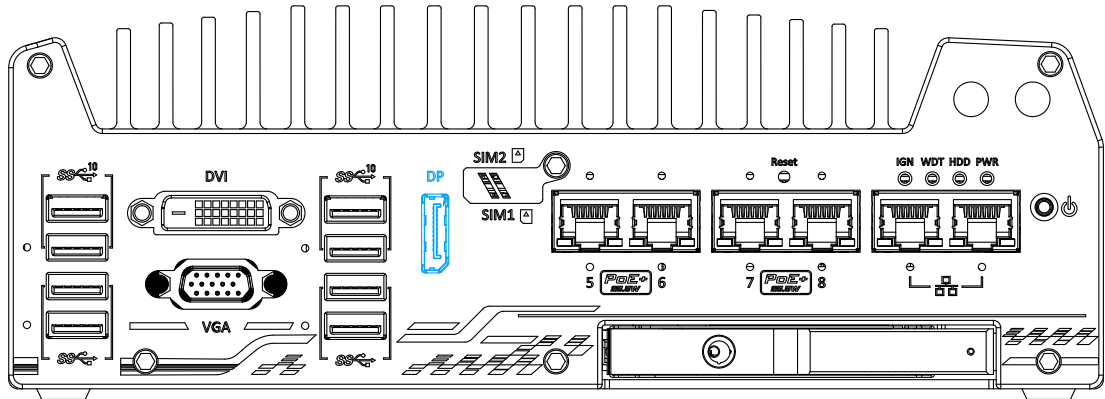

The system has a DisplayPort (DP) output which is a digital display interface that mainly connect video source and carry audio to a display device. When connecting a DP, it can deliver up to 4K UHD (4096 x 2304) in resolution. The system is designed to support passive DP adapter/ cable. You can connect to other display devices using DP-to-HDMI cable or DP-to-DVI cable.



DP-to-HDMI



DP-to-DVI

The system supports triple independent display outputs by connecting display devices to VGA, DVI and DisplayPort connection. To support multiple display outputs and achieve best DisplayPort output resolution in Windows, you need to install corresponding graphics drivers. Please refer to section [OS Support and Driver Installation](#) for details.

2.2.6 Micro-SIM (3FF) 1 & 2 Slots

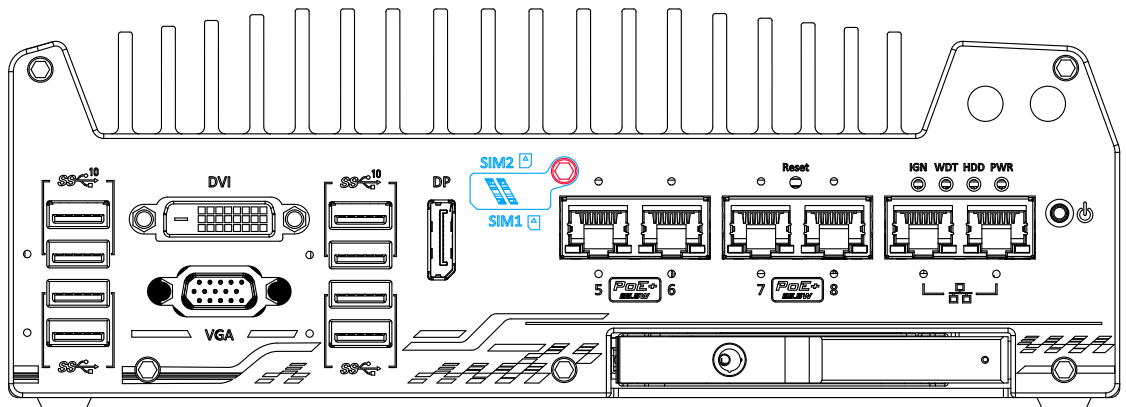

On the front panel, there are two panel-accessible Micro-SIM sockets. By installing 3G/4G modules onto the internal M.2 slot, you can access the internet via telecom operator's network. The Micro-SIM slots can be accessed by loosening the screw (indicated in red) that holds the Micro-SIM slot cover and Micro-SIM cards are secured into the sockets via push-push type mechanisms. The push-push mechanism means the SIM card is push-to-install and push-to-retrieve. Please note that the SIM1 micro-SIM card must be inserted upside-down (gold fingers facing upward) while SIM2 micro-SIM must be inserted right-side up (gold fingers facing downward).



NOTE

The dual SIM card functionality is only available when Sierra Wireless EM7455/ 7430 solution is installed. For other M.2 4G add-on solutions, SIM card 1 slot is the default functioning slot.

2.2.7 Ethernet Port/ PoE+

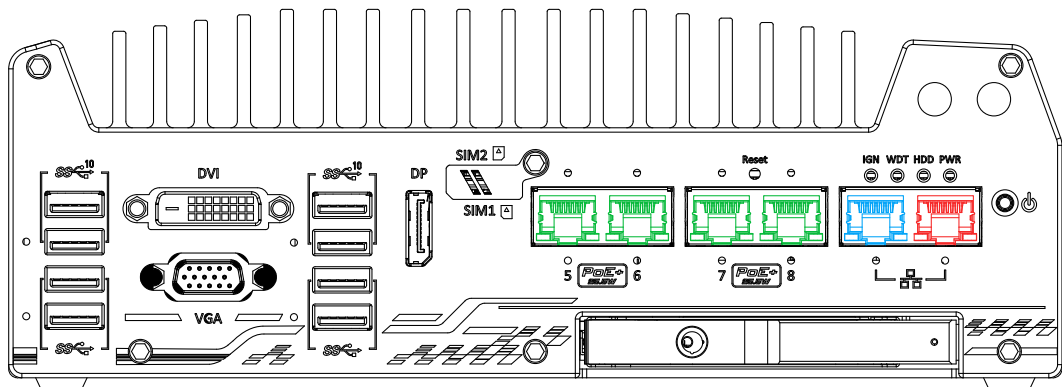

All Nuvo-7000VTC systems two GbE ports (in **red** and **blue**) while Nuvo-7108/ 7258VTC systems have four additional PoE (Power over Ethernet) ports marked in **green** on the front panel. All Ethernet ports feature panel screw fix holes for a firm connection. The port marked in **blue** is implemented using Intel® I219-LM controller that supports Wake-on-LAN and is also compatible with [Intel® AMT \(Active Management Technology\)](#) to support advanced features such as remote SOL desktop and remote on/ off control. Power over Ethernet (PoE) supplies electrical power and data on a standard CAT-5/ CAT-6 Ethernet cable. Acting as a PoE PSE (Power Sourcing Equipment), compliant with IEEE 802.3at, each PoE port delivers up to 25W to a Powered Device (PD), or 100W combined in total power delivery. PoE can automatically detect and determine if the connected device requires power or not, so it is compatible with standard Ethernet devices as well.

Each port has one dedicated PCI Express link for maximum network performance. Please refer to the table below for LED connection statuses.

Active/Link LED (Right)

LED Color	Status	Description
Yellow	Off	Ethernet port is disconnected
	On	Ethernet port is connected and no data transmission
	Flashing	Ethernet port is connected and data is transmitting/receiving

Speed LED (Left)

LED Color	Status	Description
Green or Orange	Off	10 Mbps
	Green	100 Mbps
	Orange	1000 Mbps

To utilize the GbE port in Windows, you need to install corresponding driver for Intel® I210-IT/ I219-LM GbE controller.

2.2.8 Reset Button

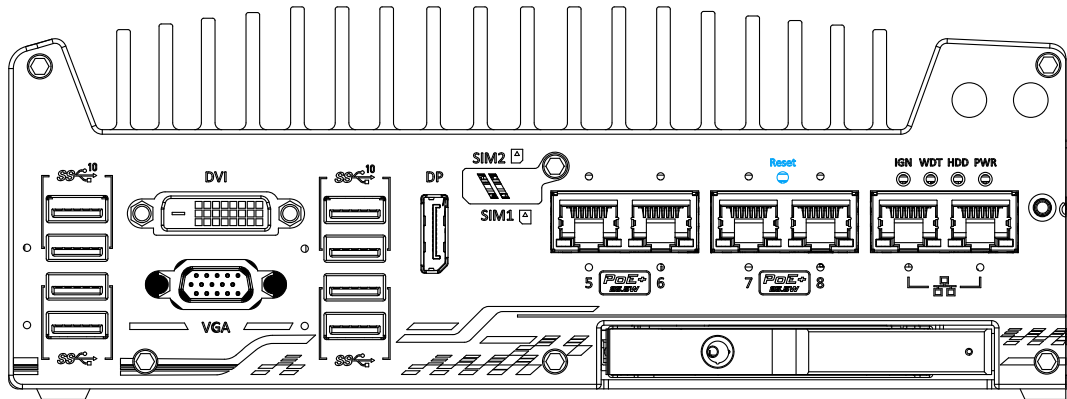

The reset button is used to manually reset the system in case of system halt or malfunction. To avoid unexpected reset, the button is purposely placed behind the panel. To reset, please use a pin-like object (eg. tip of a pen) to access the reset button

2.2.9 LED Indicators

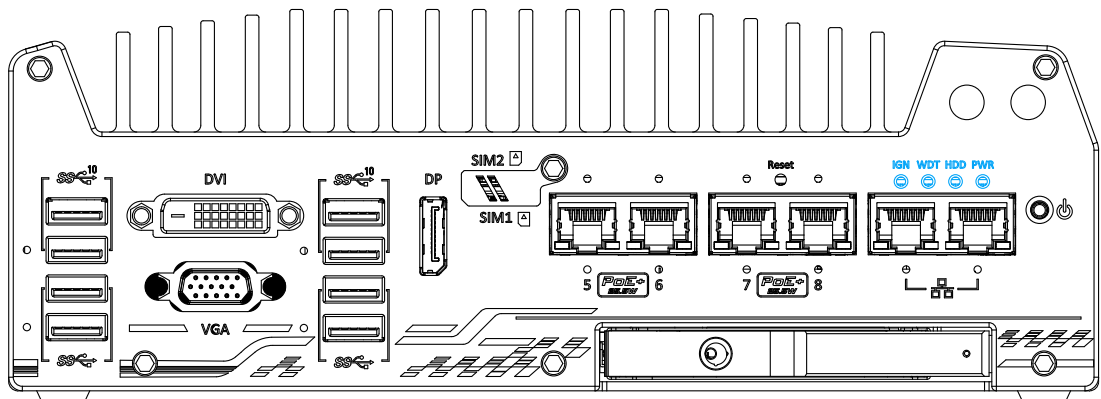

There are four LED indicators on the I/O panel: IGN, WDT, HDD and PWR. The descriptions of these four LED are listed in the following table.

Indicator	Color	Description
IGN	Yellow	Ignition signal indicator, lid when IGN is high (12V/ 24V).
WDT	Yellow	Watchdog timer LED, flashing when WDT is active.
HDD	Red	Hard drive indicator, flashing when hard disk drive is active.
PWR	Green	Power indicator, lid when system is on.

2.2.10 Power Button

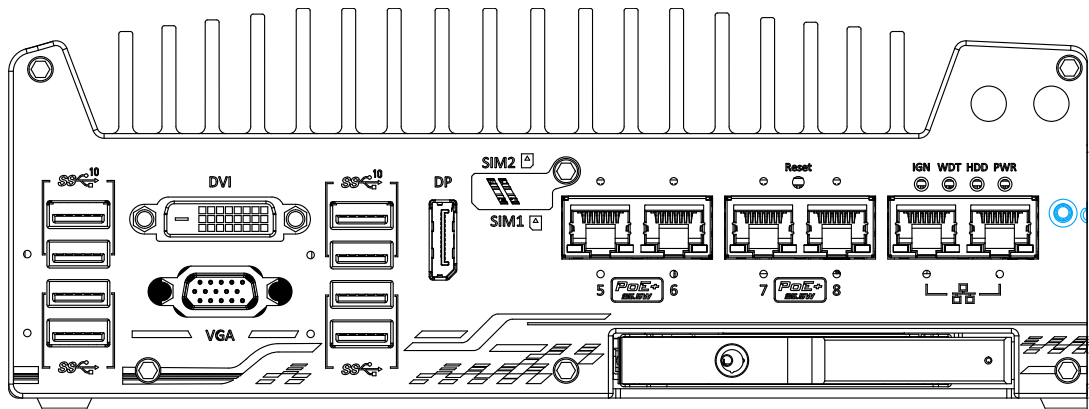

The power button is a non-latched switch for ATX mode on/off operation. To turn on the system, press the power button and the PWR LED should light-up green. To turn off the system, issuing a shutdown command in OS is preferred, or you can simply press the power button. To force shutdown when the system freezes, press and hold the power button for 5 seconds. Please note that there is a 5-second interval between on/off operations (i.e. once the system is turned off, there is a 5-second wait before you can power-on the system).

2.2.11 Hot-swappable 2.5" HDD/ SSD Slot

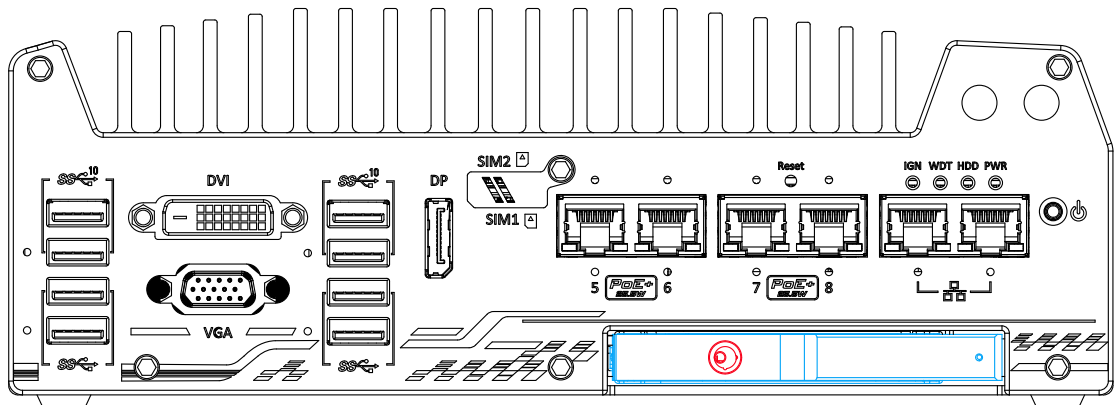

Nuvo-7100VTC series

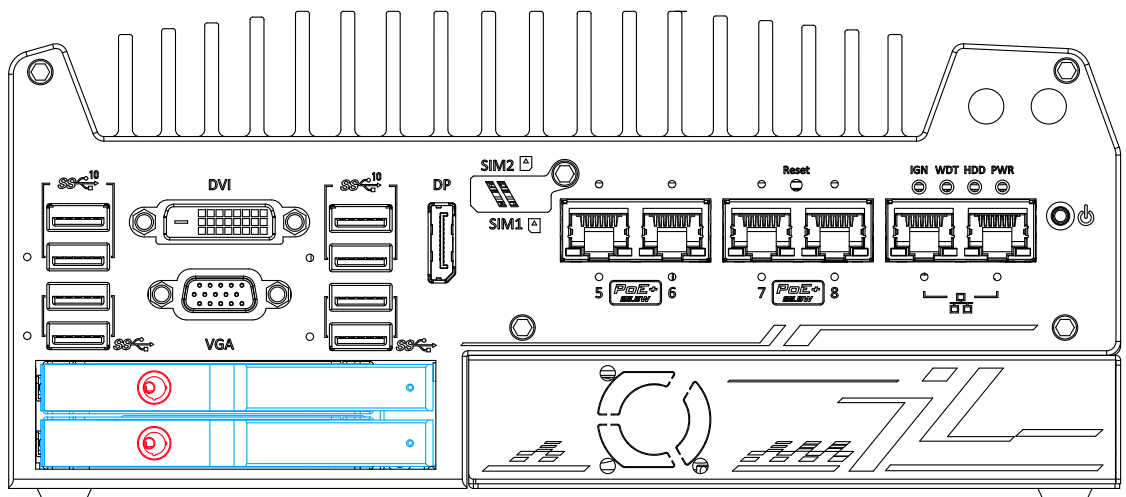

Nuvo-7200VTC/ 7250VTC series

The system supports external 2.5" HDD/ SSD hot-swappable slot(s). Designed for easy access, the HDD/ SSD slot is secured by a lock (indicated in **red**) and it supports RAID modes 0/ 1 configuration for OS installation (Nuvo-7100VTC series also has an additional internal HDD/ SSD). To set up RAID, please refer to RAID Volume Configuration section for details.

2.3 Nuvo-7000VTC Series Rear Panel I/O

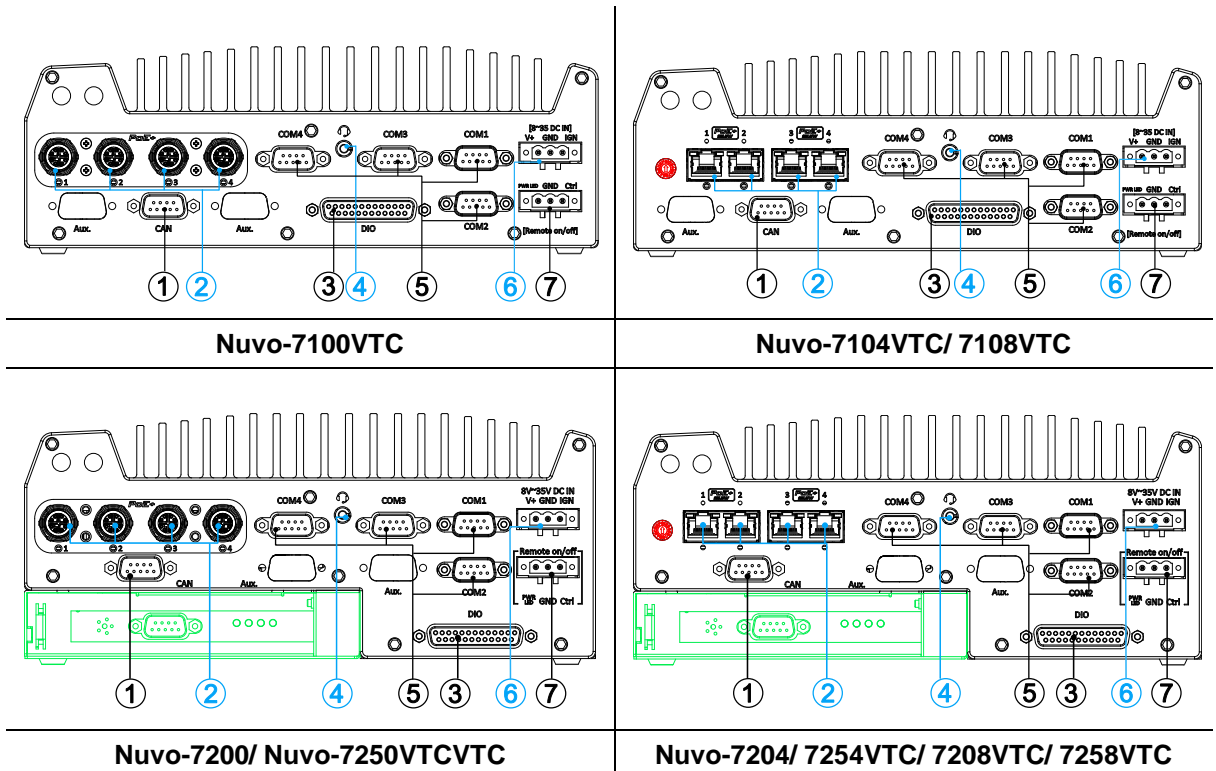

The rear panel features four RJ45 or M12 PoE ports, CAN bus, digital I/O, four COM ports, ignition control switch, 3-pin terminal and remote 3-pin on/ off control.

No.	Item	Description
1	CAN bus	Allows controller to communicate with other in-vehicle CAN device(s).
2	PoE+ GbE port	M12 x-coded connector is applicable to Nuvo-7100/ 7200/ 7250VTC systems. The rugged connection guarantees signal integrity while providing both data and electric power to devices.
		RJ45 connector is applicable to Nuvo-7104VTC/ 7204/ 7254/ 7108/ 7208/ 7258VTC systems. The Power over Ethernet (PoE) port can provide both data connection and electric power to devices.
3	Digital I/O	The DIO port provides 4x isolated digital input and 4x isolate output channels.
4	Headphone/ microphone jack	The 4-pole 3.5mm jack accepts microphone voice input and headphone speaker sound output.
5	COM ports 1-4	The four COM ports offer communication with external devices.
6	3-pin terminal	Compatible with DC power input from 8~35V, the terminal

	block (DC/ignition input)	block is also used for ignition signal input.
7	3-pin remote on/off control	Allows for external switch extension when the system is placed inside a cabinet.
Area in green	Cassette module	<p>The cassette module offers a separate compartment to manage thermal conditions and reduce installation complications of an add-on card.</p> <p>Nuvo-7200VTC series features 1x PCIe x16 slot@Gen.3 (16-lanes) for add-on card expansion.</p> <p>Nuvo-7250VTC series features a 2500 watt-second power backup solution to secure data during unforeseen power outages.</p>
	Ignition control switch	<p>The ignition control switch is available on the rear panel for Nuvo-7104/ 7108/ 7204/ 7208/ 7254/ 7258 systems.</p> <p>Note: For Nuvo-7100/ 7200/ 7250 systems, the ignition control switch can be located on the MezIO™ module.</p>

2.3.1 CAN bus Port

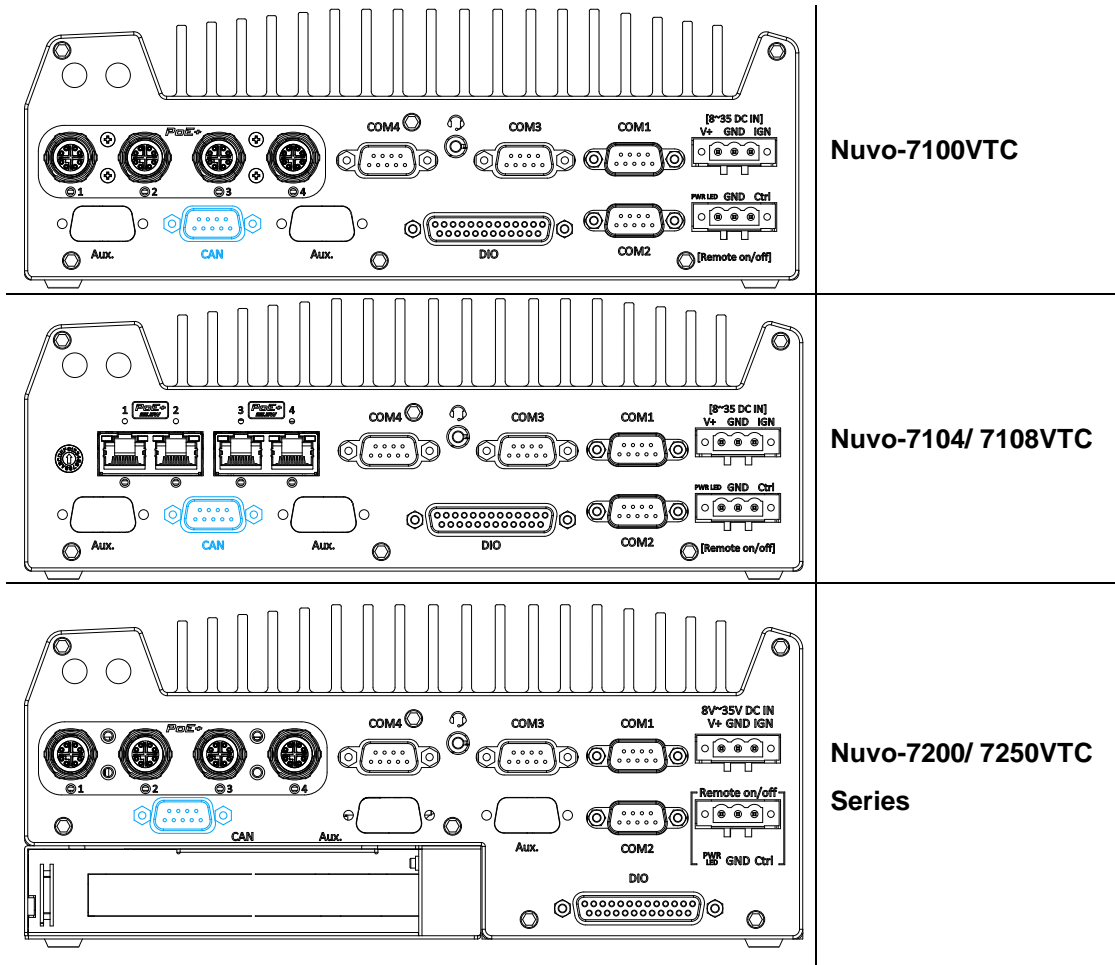

CAN bus is a robust industrial bus with a pair of differential signals and is commonly used in various industrial and in-vehicles applications. The system is equipped with a CAN bus DB9 port that is compatible with both industrial and in-vehicle applications. The CAN bus port supports CAN2.0A and CAN2.0B up to 1Mbps.

CAN bus Port Pin Definition

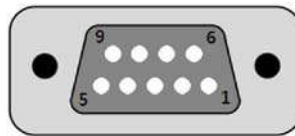

Pin No.	Definition	I/O	Description
1	GND	-	GND
2	Reserved	-	Reserved pin. Keep unconnected
3	CAN_H	I/O	CAN Bus High-level voltage
4	Reserved	-	Reserved pin. Keep unconnected
5	CAN_L	I/O	CAN Bus Low-level voltage
6	Reserved	-	Reserved pin. Keep unconnected
7	Reserved	-	Reserved pin. Keep unconnected
8	Reserved	-	Reserved pin. Keep unconnected
9	Reserved	-	Reserved pin. Keep unconnected

2.3.2 M12 Power over Ethernet Port (Nuvo-7100/ 7200/ 7250VTC)

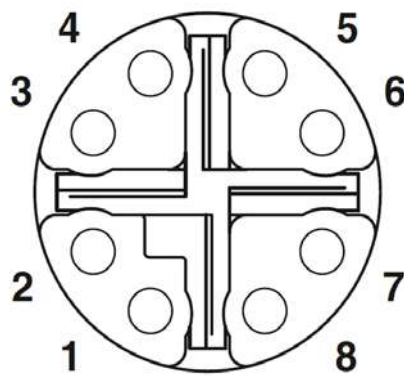
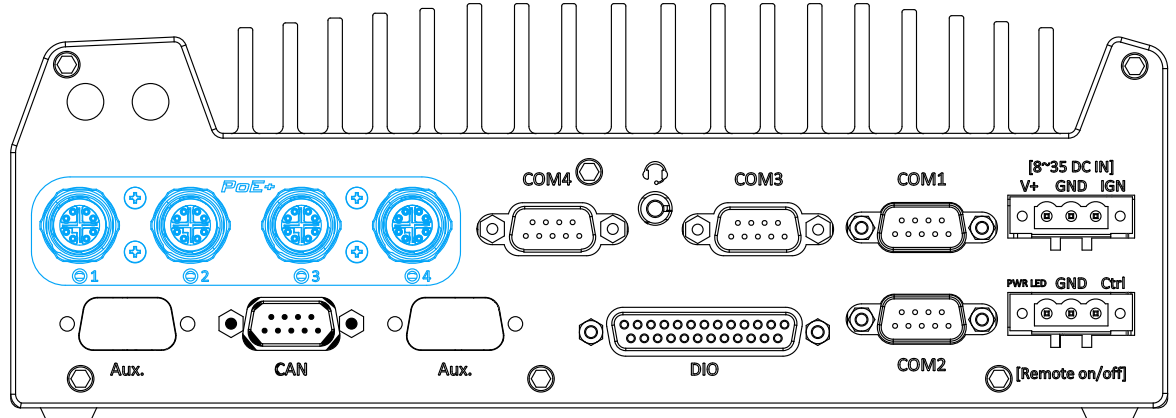



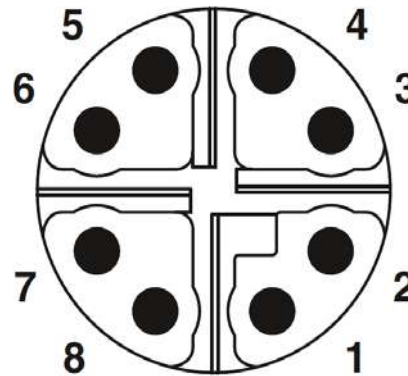





M12 socket (panel side)



M12 plug (cable side)

M12 Pin and Corresponding RJ45 Wire Connection

Wire color	Signal	M12 Pin	RJ45 Wire
	D1+	1	1
	D1-	2	2
	D2+	3	3
	D3+	8	4
	D3-	7	5
	D2-	4	6
	D4+	5	7
	D4-	6	8

PoE ports are provided via 8-pole, x-coded M12 connectors, offering extraordinary reliability for Ethernet connection. Power over Ethernet (PoE) supplies electrical power along with data on a standard Ethernet cable. As an IEEE 802.3at compliant PSE (Power Sourcing Equipment), each PoE port can deliver up to 25W of power to a Powered Device (PD), such as an IP camera. PoE is able to automatically detect the device connected and determine whether to dispatch power thus it is also compatible with traditional Ethernet devices.

2.3.3 RJ45 Power over Ethernet Port (Nuvo-7104/ 7254/ 7108/ 7258VTC)

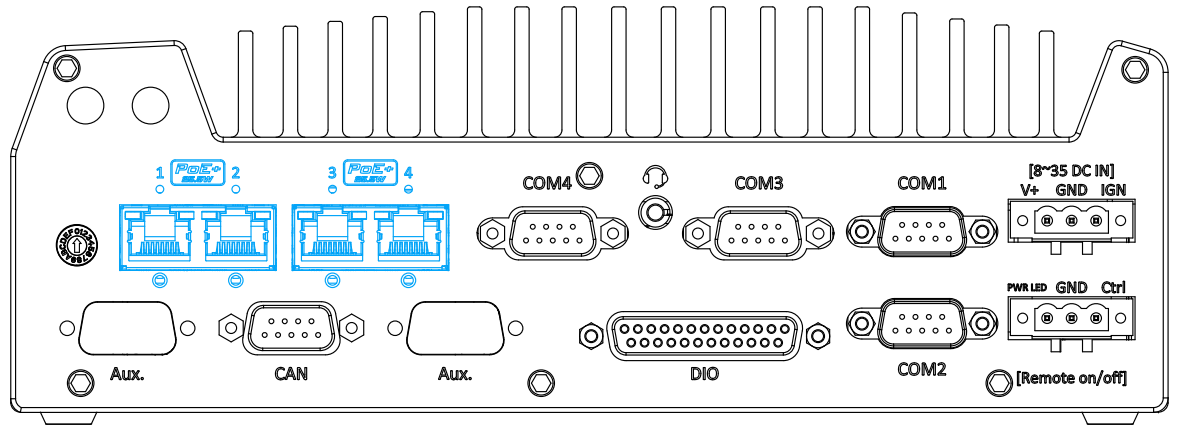

PoE ports are provided via RJ-45 connectors. Power over Ethernet (PoE) is an Ethernet technology that supplies electrical power along with data on a standard CAT-6 Ethernet cable. Acting as a Power Source Equipment (PSE), compliant with IEEE 802.3at standard, each port can deliver up to 25W of power to a Powered Device (PD), such as a PoE IP camera. PoE is able to automatically detect the device connected and determine whether to dispatch power thus it is also compatible with traditional Ethernet devices. Each port is linked to a dedicated PCI Express for maximum network performance. When plugged in, the Ethernet connection status and speed are shown on RJ45 LED indicators.

Active/Link LED

LED Color	Status	Description
Yellow	Off	Ethernet port is disconnected
	On	Ethernet port is connected and no data transmission
	Flashing	Ethernet port is connected and data is transmitting/receiving

Speed LED

LED Color	Status	Description
Green or Orange	Off	10 Mbps
	Green	100 Mbps
	Orange	1000 Mbps

2.3.4 Digital Input/ Output

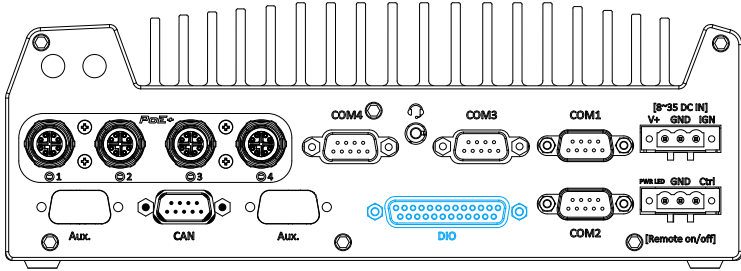
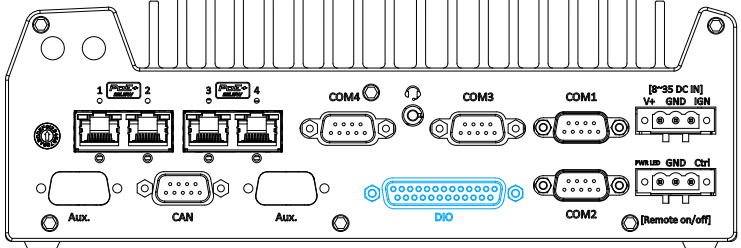
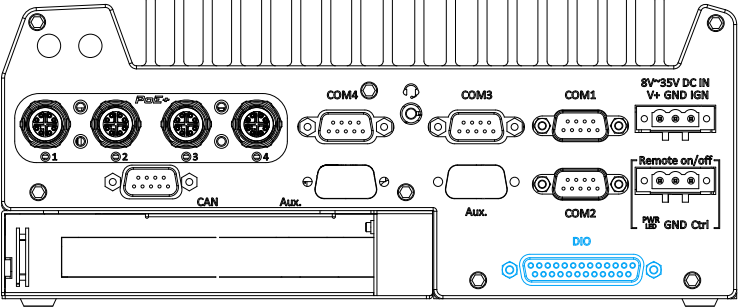
	<p>Nuvo-7100VTC</p>
	<p>Nuvo-7104VTC/ Nuvo-7108VTC</p>
	<p>Nuvo-7200VTC/ 7250VTC Series</p>

The system provides 4x isolated digital input channels and 4x isolated digital output channels. The DIO functions support polling mode I/O access and DI change-of-state interrupt. Please refer to digital I/O pin definition on the following page and [Watchdog Timer & Isolated DIO](#) for information on wiring and programming the isolated DIO channels.

Digital I/O Pin Definition

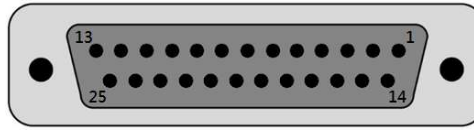

Pin No.	Definition	I/O	Description
1	ISO_DI3H	I	Digital input channel 3
2	ISO_DI2H	I	Digital input channel 2
3	ISO_DI1H	I	Digital input channel 1
4	ISO_DI0H	I	Digital input channel 0
5	Reserved	-	Reserved pin. Keep unconnected
6	Reserved	-	Reserved pin. Keep unconnected
7	ISO_DO3	O	Digital output channel 3
8	ISO_DO2	O	Digital output channel 2
9	ISO_DO1	O	Digital output channel 1
10	ISO_DO0	O	Digital output channel 0
11	VDD	-	DO voltage source input for inductive load
12	Reserved	-	Reserved pin. Keep unconnected
13	Reserved	-	Reserved pin. Keep unconnected
14	ISO_DI3L	-	Digital input channel 3 GND
15	ISO_DI2L	-	Digital input channel 2 GND
16	ISO_DI1L	-	Digital input channel 1 GND
17	ISO_DI0L	-	Digital input channel 0 GND
18	Reserved	-	Reserved pin. Keep unconnected
19	Reserved	-	Reserved pin. Keep unconnected
20	DO_GND	O	Digital output ground
21	DO_GND	O	Digital output ground
22	DO_GND	O	Digital output ground
23	DO_GND	O	Digital output ground
24	DO_GND	O	Digital output ground
25	Reserved	-	Reserved pin. Keep unconnected

2.3.5 COM Ports

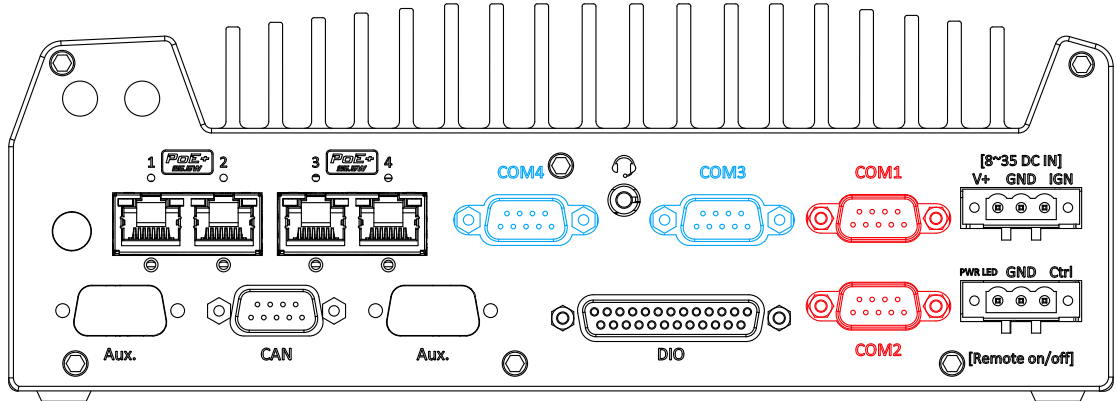

The system provides four COM ports for communicating with external devices. These COM ports are implemented using industrial-grade ITE8786 Super IO chip (-40 to 85°C) and provide up to 115200 bps baud rate.

COM1 and COM2 (in red) are software-configurable RS-232/ 422/ 485 ports. COM3 and COM4 (in blue) are standard 9-wire RS-232 ports. The operation mode of COM1 and COM2 can be set in BIOS setup utility. The following table describes the pin definition of COM ports.

COM Port Pin Definition

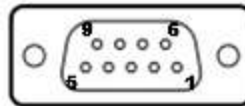

Pin#	COM1 & COM2			COM3 & COM4
	RS-232 Mode	RS-422 Mode	RS-485 Mode (Two-wire 485)	RS-232 Mode
1	DCD			DCD
2	RX	422 TXD+	485 TXD+/RXD+	RX
3	TX	422 RXD+		TX
4	DTR	422 RXD-		DTR
5	GND	GND	GND	GND
6	DSR			DSR
7	RTS			RTS
8	CTS	422 TXD-	485 TXD-/RXD-	CTS
9	RI			RI

2.3.6 3-Pin Terminal Block for DC and Ignition Input

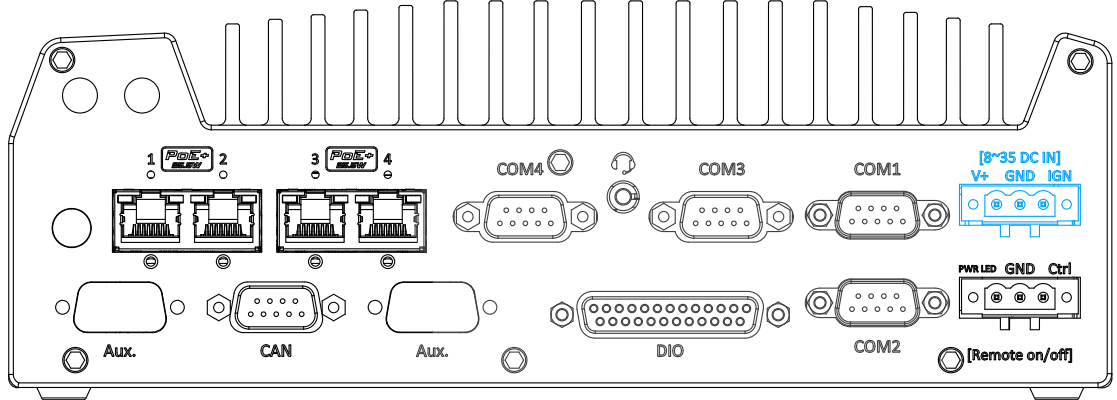

The system accepts a wide range of DC power input from 8 to 35V via a 3-pin pluggable terminal block, which is fit for field usage where DC power is usually provided. The screw clamping mechanism on the terminal block offers connection reliability when wiring DC power.

In addition to DC power input, this terminal block can also accept ignition signal input (IGN) when ignition control module (eg. MezIO-V20) is installed for in-vehicle applications.

⚠ WARNING

Please make sure the voltage of DC power is correct before you connect it to the system. Supplying a voltage over 35V will damage the system.

2.3.7 3-Pin Remote On/ Off

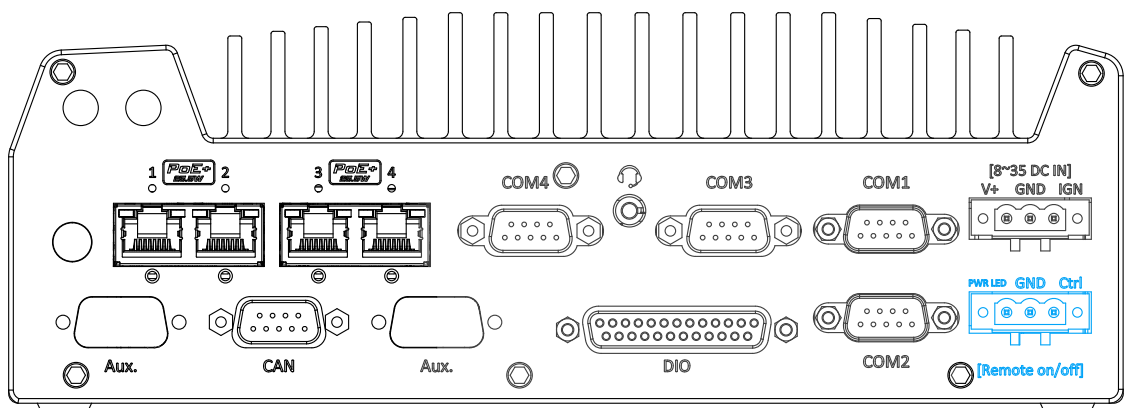

The “Remote On/ Off” 3-pin connection allows for external switch extension. It is useful when the system is placed in a cabinet or a not easily accessed location. You may connect an external status LED (20mA) indicator by connecting to PWR LED and GND.

2.3.8 PB-2500J LED Status Indicators (Nuvo-7250VTC Series Only)

There are four LED indicators on PB-2500J's panel and their status descriptions are listed in the following table

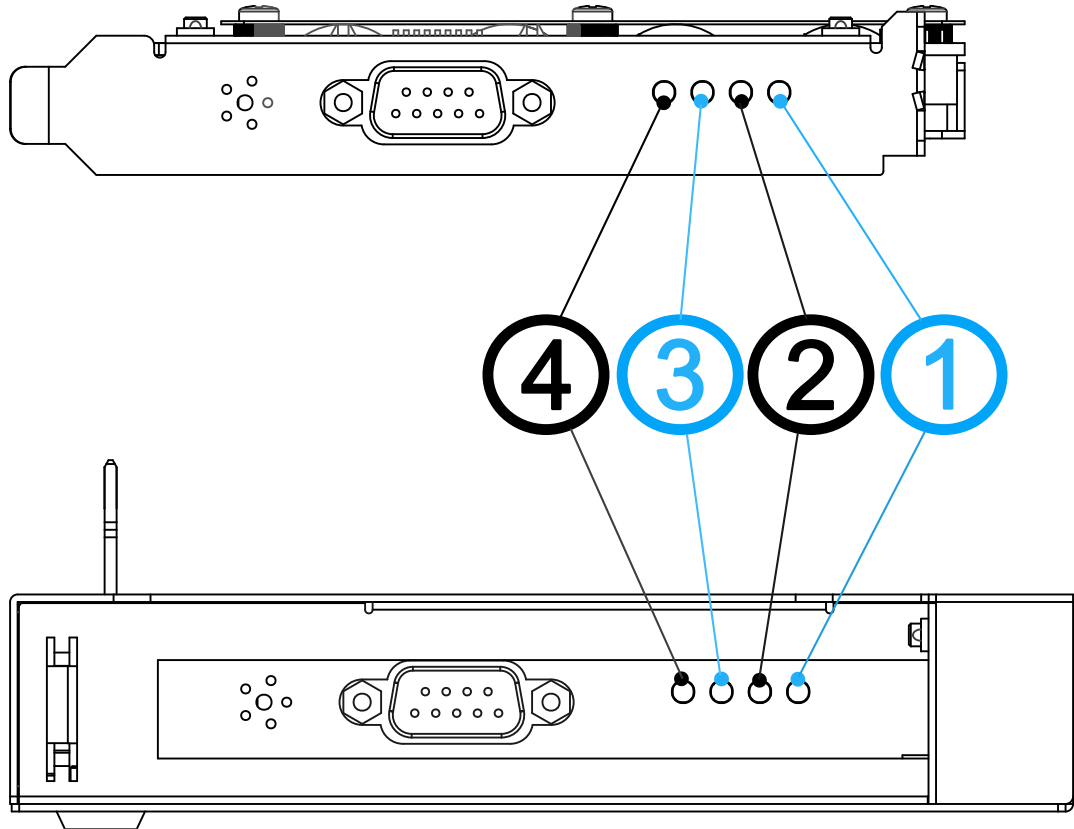

LED	Color	Status	Description
1	Green	Off	Energy of the SuperCAP is below 1736J
		Steady-lid	Energy of the SuperCAP reached 2500J
		Flashing	Energy of the SuperCAP reach 1736J
2	Green	Off	Energy of the SuperCAP is below 625J
		Steady-lid	Energy of the SuperCAP reached 1111J
		Flashing	Energy of the SuperCAP reach 625J
3	Orange		When lid, it indicates PB-2500J-PCIe is being charged.
4	Red		When Lid, it indicates a brownout status.

2.4 Internal I/O Functions

In addition to I/O connectors on the front panel, the system also provides internal on-board connectors, such as remote on/off control, LED status output, internal USB 2.0 ports, etc. In this section, we'll illustrate these internal I/O functions.

2.4.1 Clear CMOS Button

The Clear CMOS button is used to manually reset the motherboard BIOS in case of system halt or malfunction. To avoid unexpected operation, the button is purposely placed behind the panel. To clear the CMOS, please refer to the following procedure.

1. Please power off and unplug the system, and refer to the section [Disassembling the System](#) on how to remove the front panel.
2. Once the front panel has been removed, the Clear CMOS button can be located at the top of the USB port (indicated in [blue circle](#)).

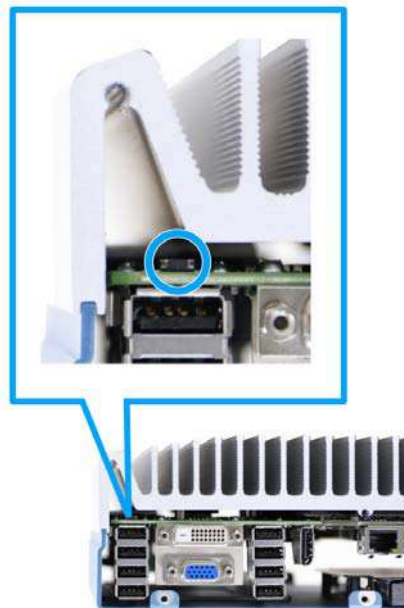

3. To clear the CMOS, press and hold the button for at least 5 seconds.
4. [Reinstall the system front panel](#) when done.

WARNING

Clearing the CMOS will reset all BIOS settings to default and may result in down time!

If you have RAID volume configured, please backup all data as clearing the CMOS may result in data loss!

2.4.2 Dual SODIMM DRAM Slot

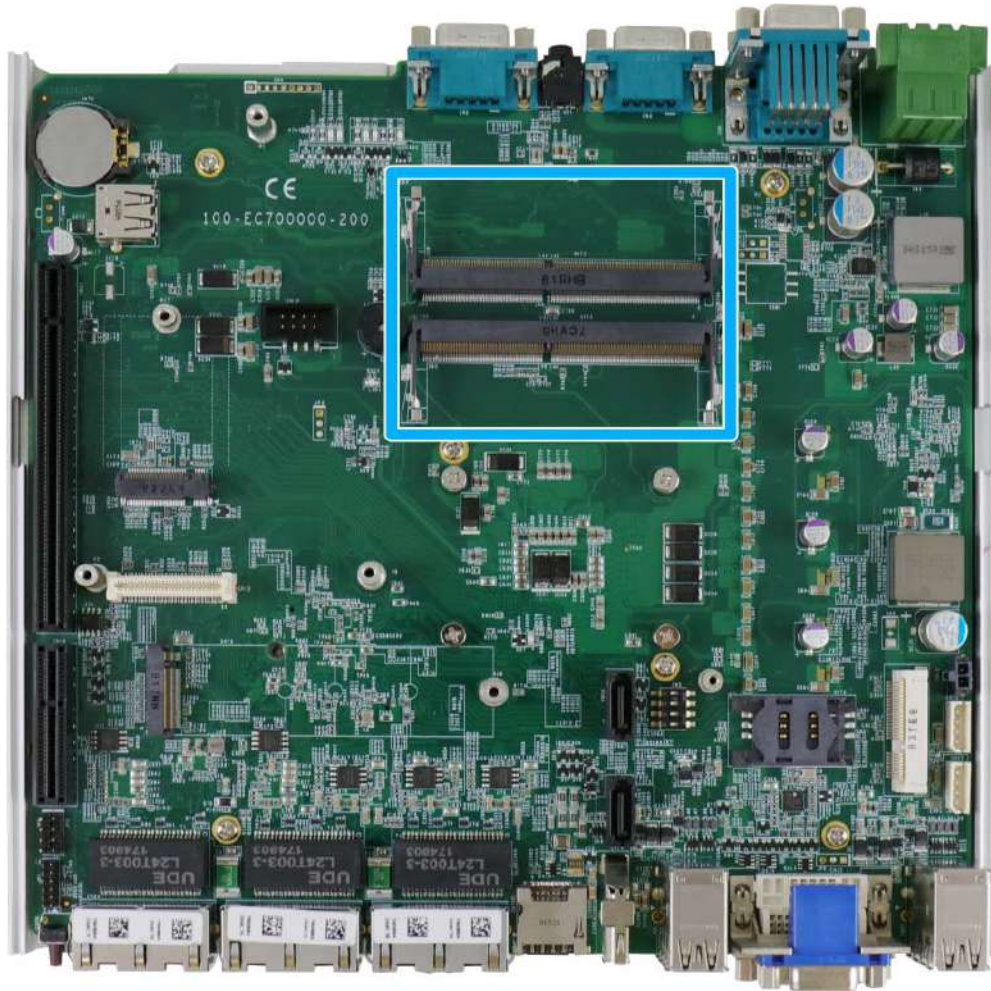

The system motherboard supports two 260-pin SODIMM socket for installing DDR4 memory module up to 64GB. Each slot supports single module DDR4 2666MHz SODIMM up to 32GB capacity.



NOTE

When changes are made to DRAM module(s), such as additionally install or remove and reinstall (into the same/ different slot), it will result in approximately a 30 to 60 seconds delay when booting up for the first time after such change(s).

2.4.3 Dual Mode mSATA/ mini-PCle Socket & Pin Definition

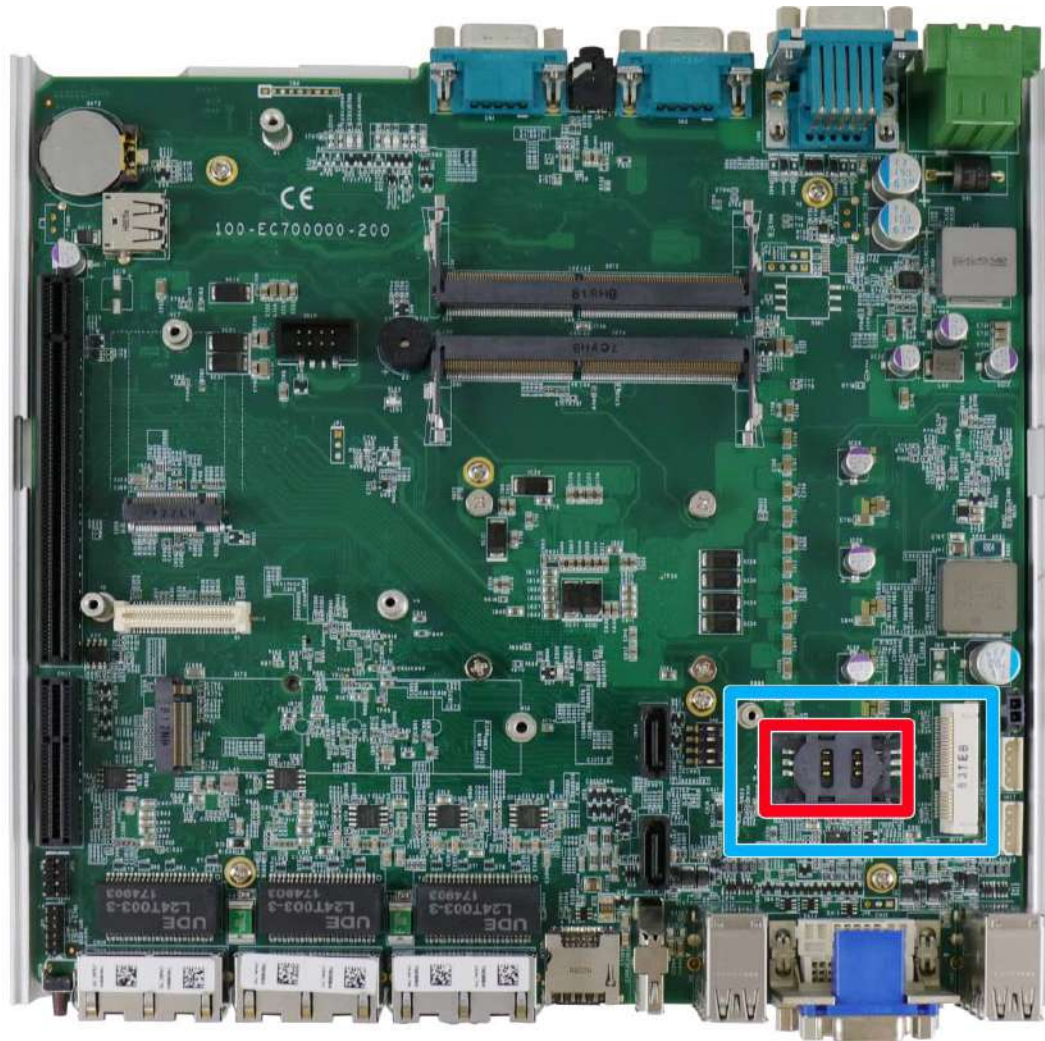

The system provides a dual mode mSATA/ mini-PCle socket (indicated in blue) that is in compliance with mini-PCle specification rev. 1.2. You can install either an mSATA SSD or mini-PCle module into this socket and the system will automatically detect and configure it to run PCIe or SATA signals. This mini-PCle socket is designed with SIM card (slot indicated in red) support. With a SIM card installed, your system can access the internet via your network provider's 3G/ 4G network.

For wireless (WIFI/ 3G/ 4G) communication, multiple SMA antenna apertures can be located on the front and rear panel.

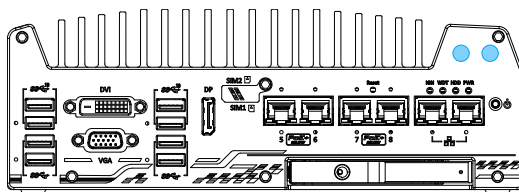

Front panel antenna opening

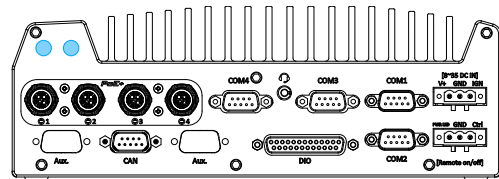

Rear panel antenna opening

Dual mode mSATA/ mini-PCle socket definition

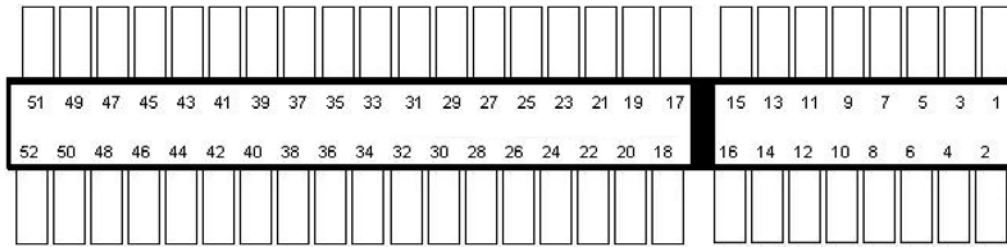

Pin	Signal (mPCle)	Signal (mSATA)	Pin #	Signal (mPCle)	Signal (mSATA)
1	WAKE#	-	2	+3.3Vaux	3.3V
3	-	-	4	GND	GND
5	-	-	6	+1.5V	+1.5V
7	CLKREQ#	-	8	UIM_PWR	-
9	GND	GND	10	UIM_DATA	-
11	REFCLK-	-	12	UIM_CLK	-
13	REFCLK+	-	14	UIM_RESET	-
15	GND	GND	16	UIM_VPP	-
Mechanical Key					
17	Reserved*	-	18	GND	GND
19	Reserved*	-	20	W_DISABLE#	-
21	GND	GND	22	PERST#	-
23	PERn0	SATA_Rxp	24	3.3V	3.3V
25	PERp0	SATA_Rxn	26	GND	GND
27	GND	GND	28	+1.5V	+1.5V
29	GND	GND	30	SMB_CLK	SMB_CLK
31	PETn0	SATA_Txn	32	SMB_DATA	SMB_DATA
33	PETp0	SATA_Txp	34	GND	GND
35	GND	GND	36	USB_D-	-
37	GND	GND	38	USB_D+	-
39	3.3V	3.3V	40	GND	GND
41	3.3V	3.3V	42	-	-
43	GND	-	44	-	-
45	Reserved	-	46	-	-
47	Reserved	-	48	+1.5V	+1.5V
49	Reserved	-	50	GND	GND
51	Reserved	-	52	3.3V	3.3V



WARNING

Some off-the-shelf mini-PCle 4G modules are not compliant to standard mini-PCle interface. They use 1.8V I/O signals instead of standard 3.3V I/O and may have signal conflict. Please consult with Neousys for compatibility when in doubt! Installing an incompatible 4G module may damage the system or the module itself may be damaged.

2.4.4 M.2 2242 (B Key), Mini-SIM Card Slot & Pin Definition



The dual SIM card functionality is only available when Sierra Wireless EM7455/ 7430 solution is installed. For other 4G add-on solutions, SIM card slot 1 is the default functioning slot.

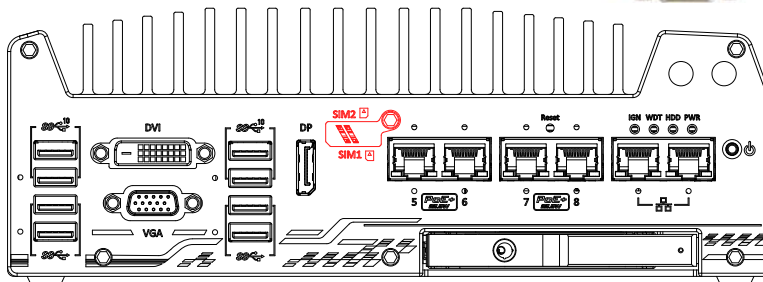
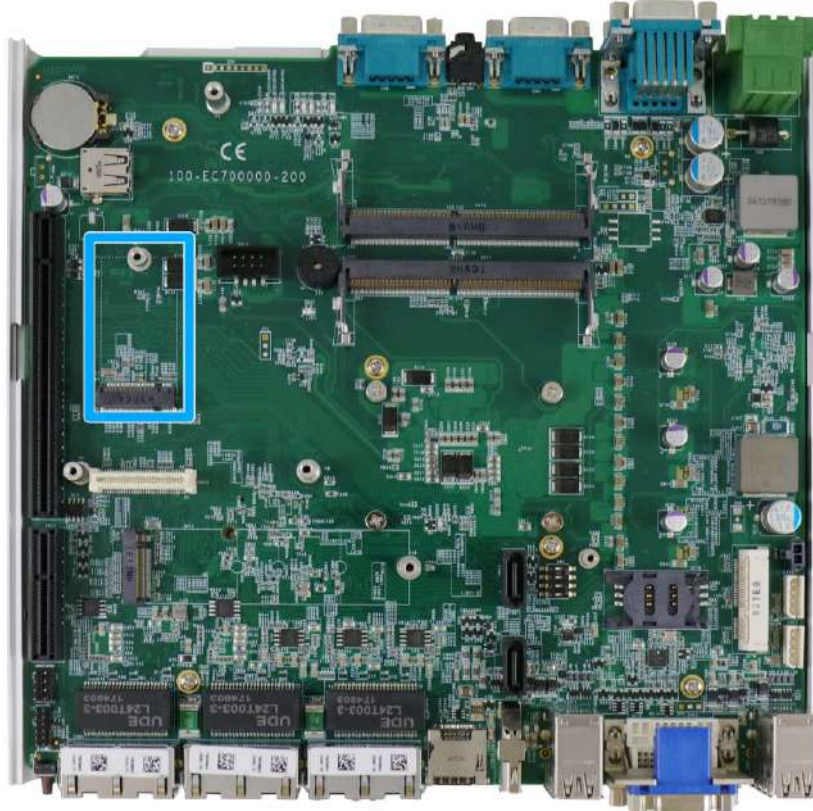

The system has an M.2 2242 slot (indicated in **blue**) that works with dual SIM slots (4G + 3G) on the front panel (indicated in **red**). By installing a 3G or 4G M.2 module and SIM card, you can access the internet via the provider's network.

For wireless 3G/ 4G, SMA antenna apertures are located on front/ rear panels.

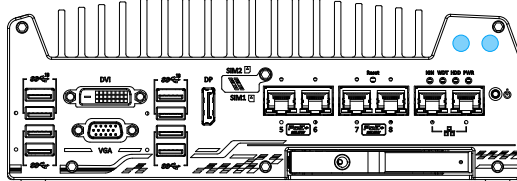

Front panel antenna opening

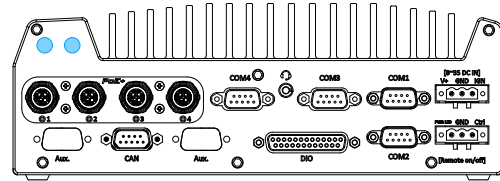

Rear panel antenna opening

M.2 (B Key) Slot Pin Definition

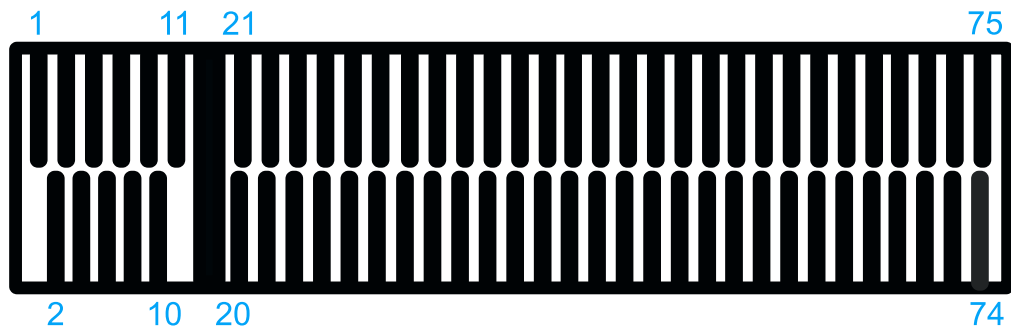

Pin #	Signal	Pin #	Signal
1	-	2	P3V3
3	GND	4	P3V3
5	GND	6	-
7	USB D+	8	-
9	USB D-	10	-
11	GND	12	KEY
13	KEY	14	
15		16	
17		18	
19		20	-
21	-	22	-
23	-	24	-
25	-	26	-
27	GND	28	-
29	-	30	UIM_RST
31	-	32	UIM_CLK
33	GND	34	UIM_DATA
35	-	36	UIM_PWR
37	-	38	-
39	GND	40	-
41	-	42	-
43	-	44	-
45	GND	46	-
47	-	48	-
49	-	50	PLTRST
51	GND	52	-
53	-	54	-
55	-	56	-
57	GND	58	-
59	-	60	-
61	-	62	-
63	-	64	-
65	-	66	-
67	PLTRST	68	-
69	-	70	P3V3
71	GND	72	P3V3
73	GND	74	P3V3
75	-		

2.4.5 SATA Ports

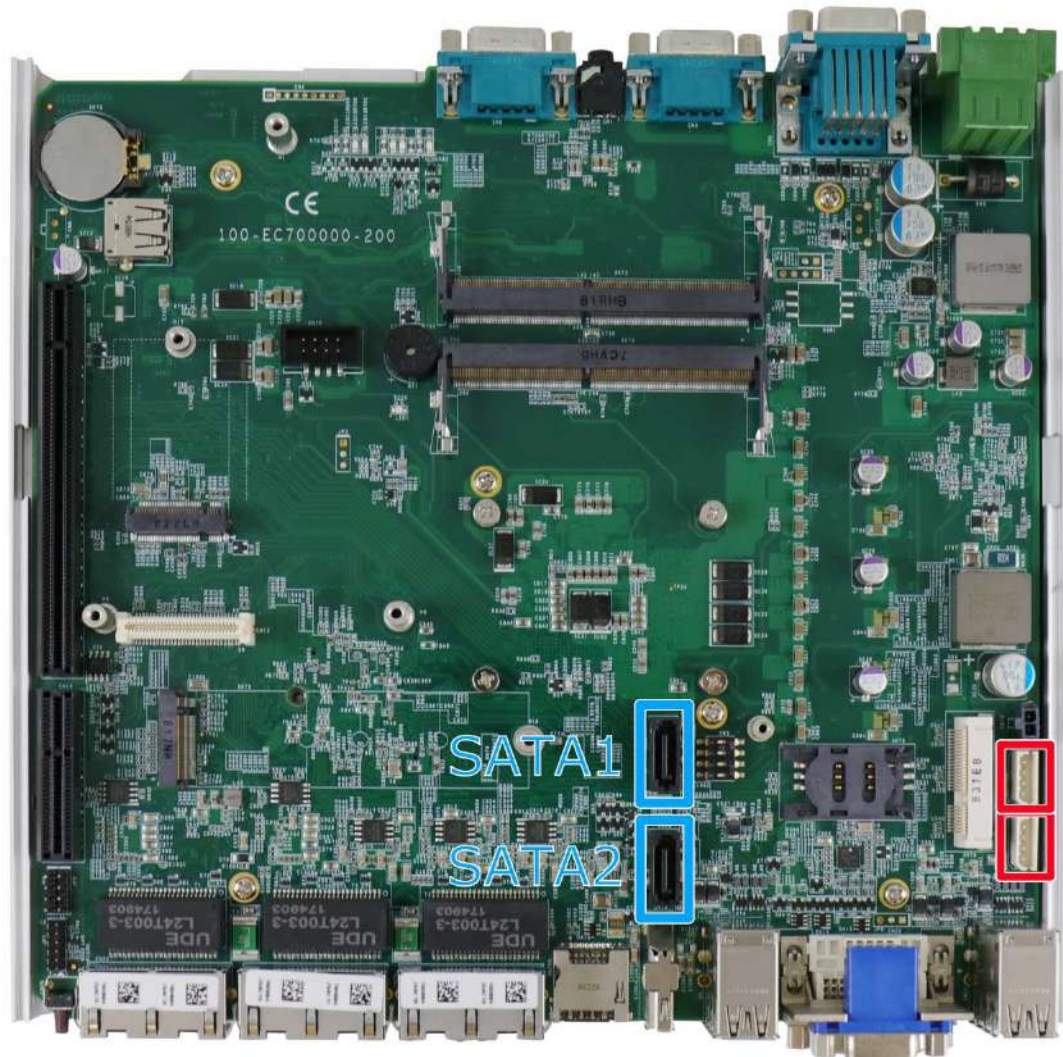

The system provides two SATA ports which support Gen3, 6 Gb/s SATA signals. Each SATA port (indicated in **blue**) features a 7-pin SATA connector and a 4-pin power connector (indicated in **red**).

A pair of SATA and power connector can accommodate one 2.5" HDD/ SSD. Standard 22-pin SATA connectors are provided with the system. You may refer to the SATA Configuration section for SATA settings.

2.4.6 DIP Switch

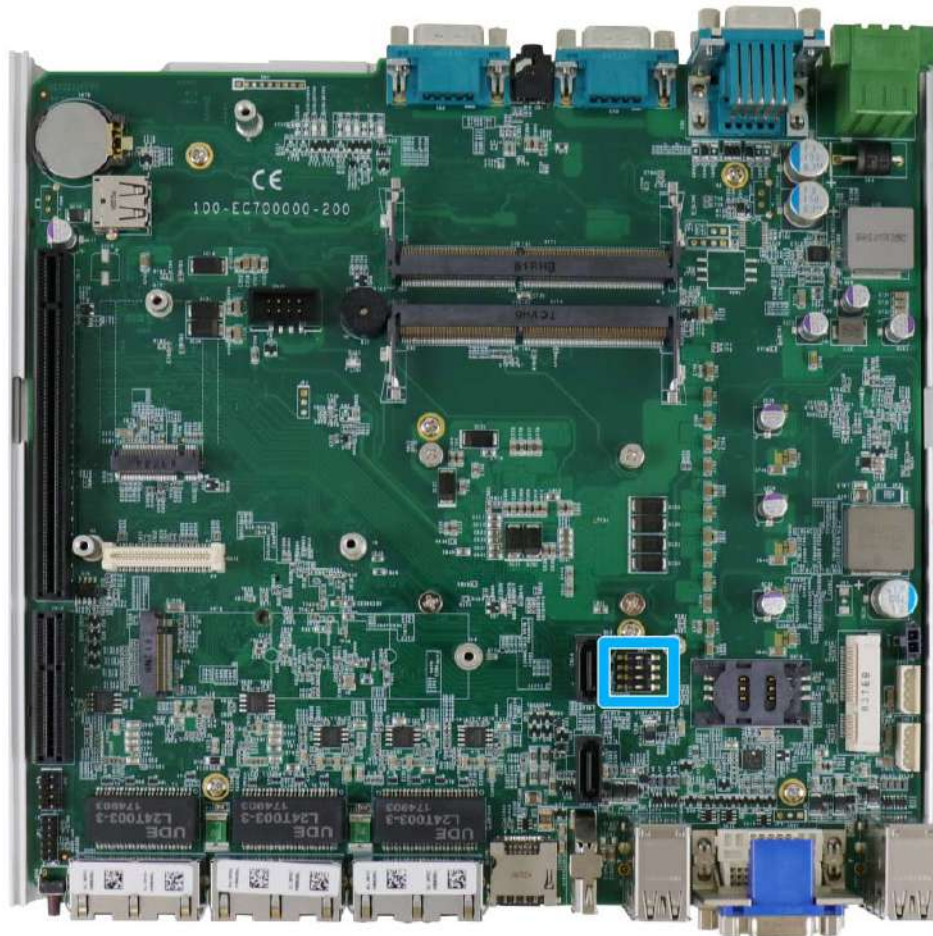

The DIP switch (indicated in **blue**) should be already configured out of the factory. Users need only set the 4th DIP switch to ON for BIOS update and switch it back to the OFF position when BIOS upgrade has completed. The table below shows the system default DIP switch settings for reference purposes.

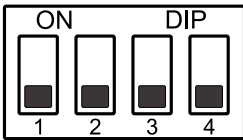
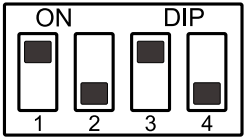
System	Default DIP switch setting
Nuvo-7100VTC	
Nuvo-7200/ 7250VTC	



NOTE

Changing any DIP switches to the ON or OFF position will result in extra detection time during the start up process.

2.4.7 On/ Off Ctrl & Status Output

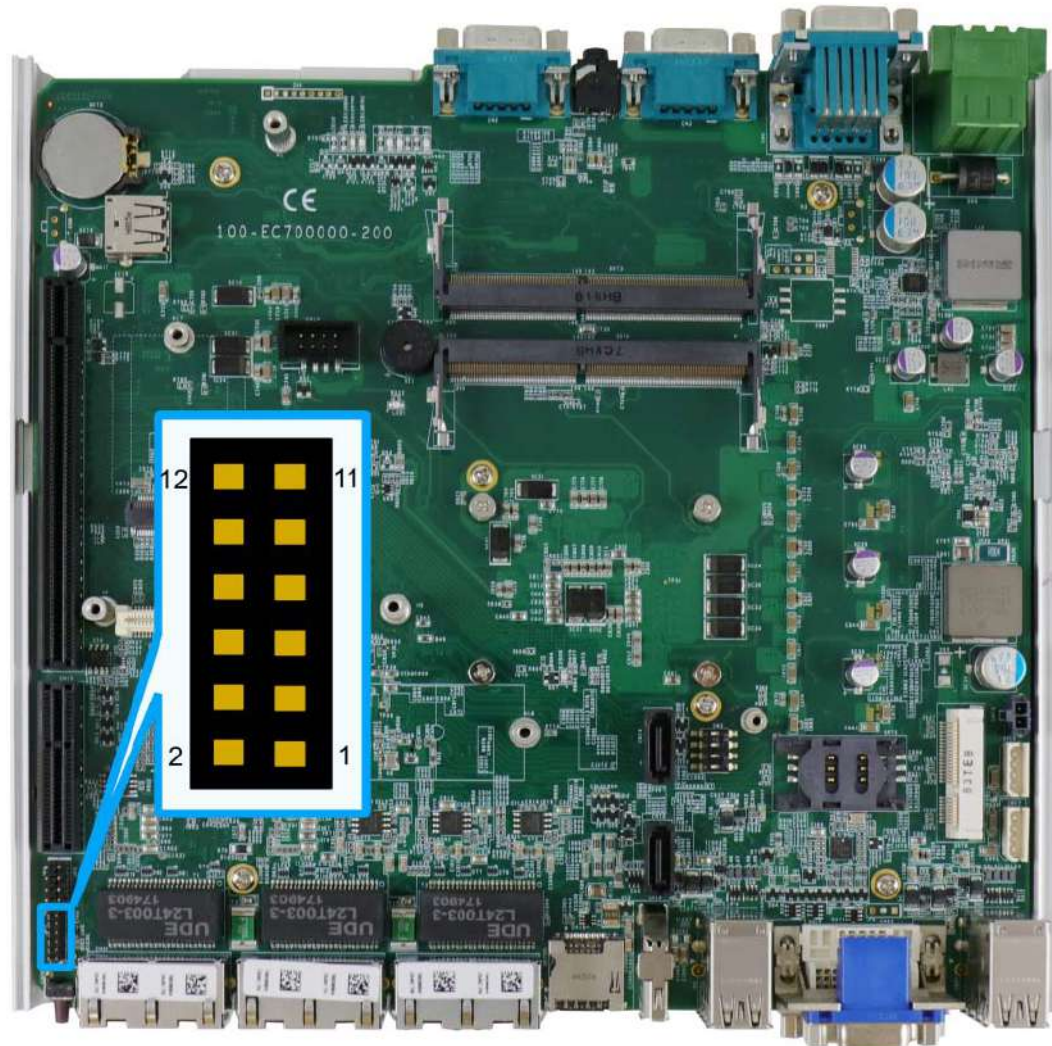

Pin#	Definition	Description
1	WDT_LED-	[Output] Watchdog timer indicator, flashing when Watchdog timer is active
2	WDT_LED+	
3	Standby Power-	[Output] Standby power indicator, on if DC power is applied and system is in S5 (standby) mode.
4	Standby Power+	
5	HDD-	[Output] Hard drive indicator, flashing when SATA hard drive is active.
6	HDD+	
7	Power-	[Output] System power indicator, on if system is turned on, off if system is turned off.
8	Power+	
9	Ctrl-	[Input] Remote on/off control, connects to an external switch to turn on/off the system (polarity is negligible).
10	Ctrl+	
11	IGN_LED-	[Output] Ignition control indicator, on if ignition control is on, off if ignition control is off.
12	IGN_LED+	

2.4.8 Internal USB 2.0 Port

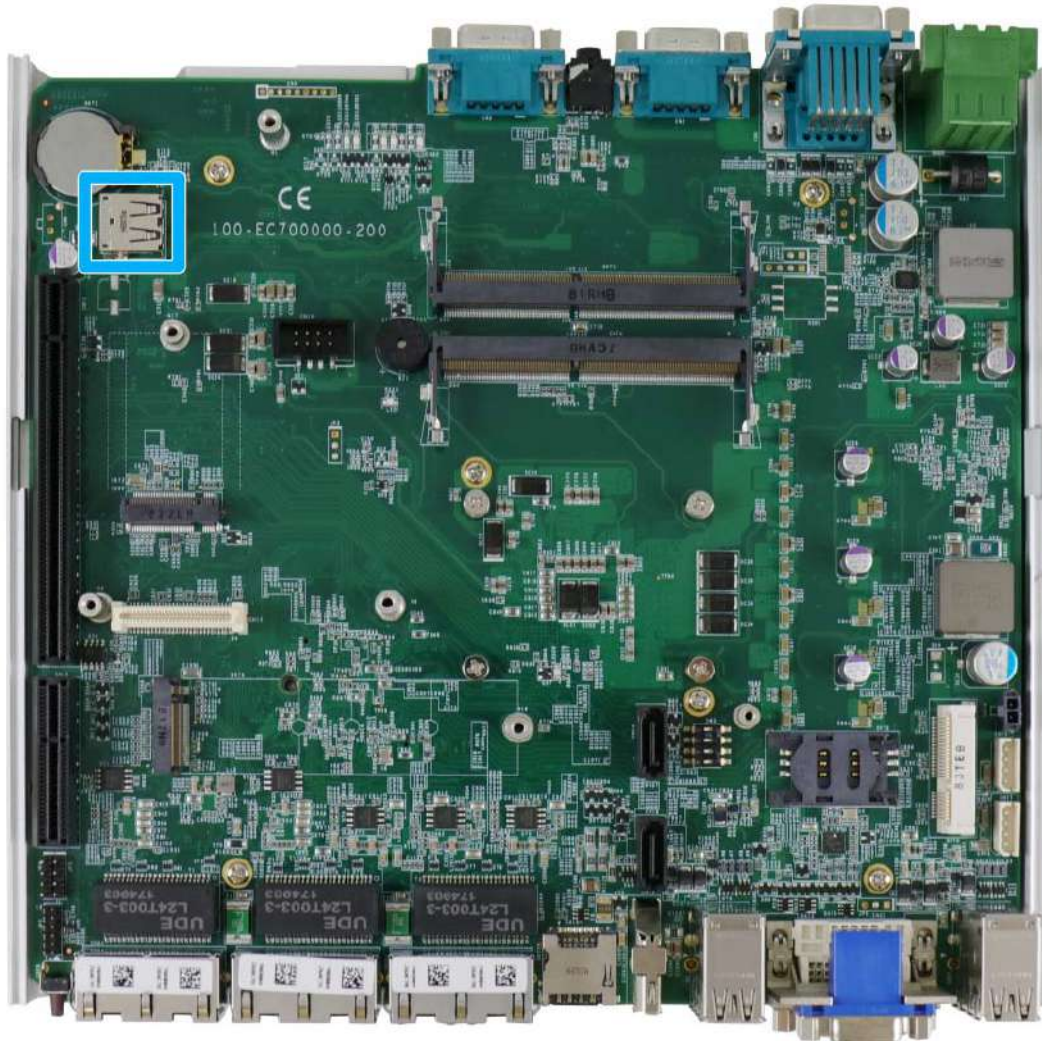

The system's motherboard has an internal USB2.0 port on the PCBA. You can utilize this USB port to connect a USB protection dongle inside the chassis of the system.

2.4.9 M.2 2280 (M Key) Slot for NVMe SSD or Optane™ Memory

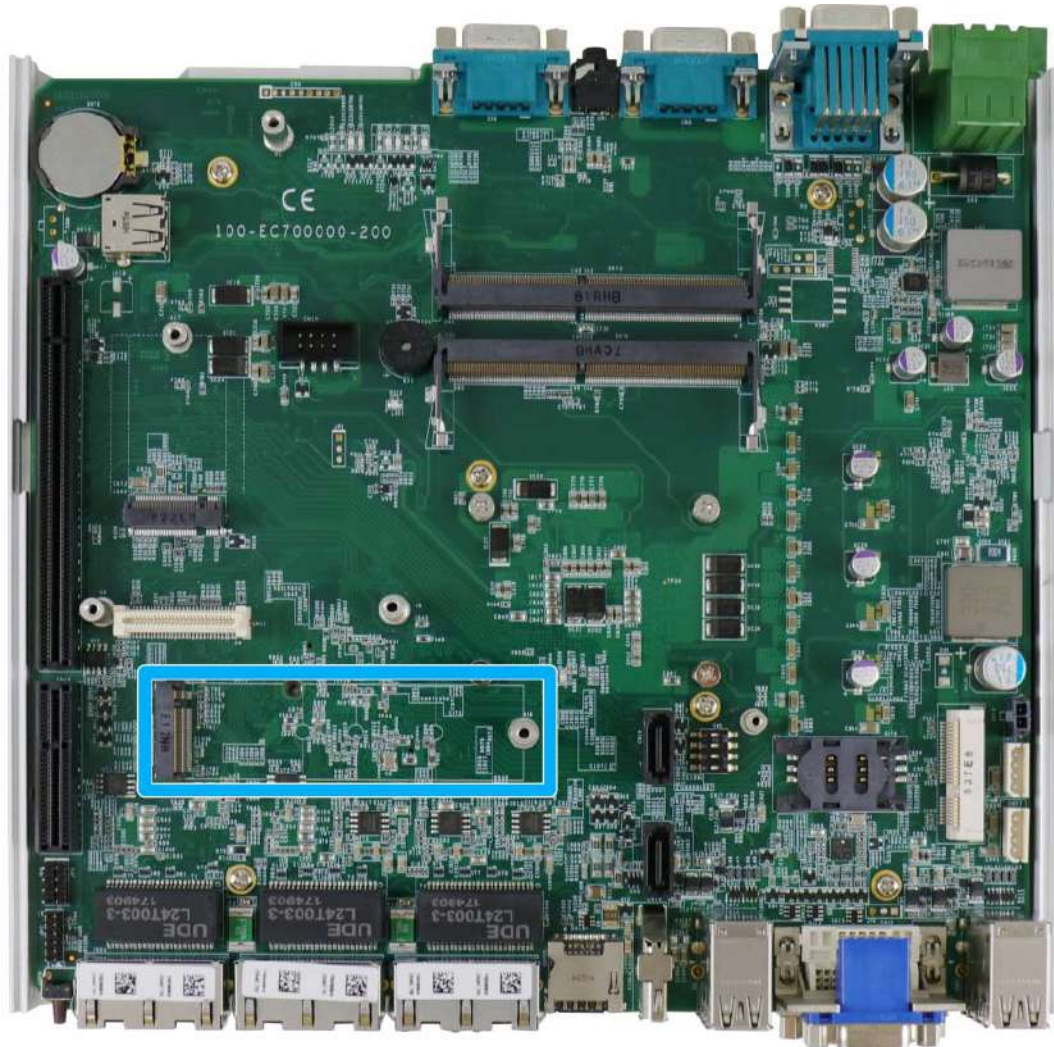

The system has an x4 PCIe M.2 2280 slot (also in compliance with SATA signal) for you to install an NVMe SSD for the ultimate performance or an Intel® Optane™ memory to accelerate the read/ write performances of traditional hard disk drive. An NVMe SSD offers exceptional performance over 2.5" SSDs while Intel® Optane™ memory can dramatically boost your traditional hard disk drives' read/ write performances.



NOTE

The M.2 slot will automatically detect and configure the slot to run PCIe or SATA signal depending on the installed device.

M.2 (M Key) Slot Pin Definition

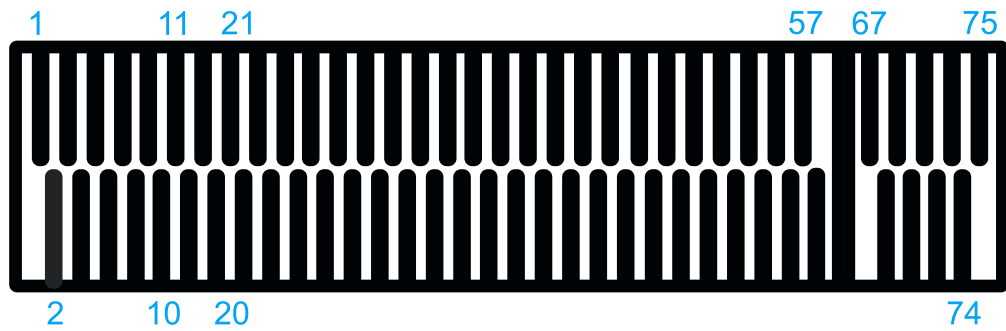

Pin #	Signal	Pin #	Signal
1	GND	2	+3V3
3	GND	4	+3V3
5	PERN3	6	-
7	PERP3	8	-
9	GND	10	DAS/DSS_N
11	PETN3	12	+3V3
13	PETP3	14	+3V3
15	GND	16	+3V3
17	PERN2	18	+3V3
19	PERP2	20	-
21	GND	22	-
23	PETN2	24	-
25	PETP2	26	-
27	GND	28	-
29	PERN1	30	-
31	PERP1	32	-
33	GND	34	-
35	PETN1	36	-
37	PETP1	38	-
39	GND	40	-
41	PERn0 / SATA-B+	42	-
43	PERp0 / SATA-B-	44	-
45	GND	46	-
47	PETn0 / SATA-A-	48	-
49	PETp0 / SATA-A+	50	PERST_N
51	GND	52	-
53	REFCLKN	54	-
55	REFCLKP	56	-
57	GND	58	-
Mechanical Key			
67	-	68	SUSCLK
69	PEDET	70	+3V3
71	GND	72	+3V3
73	GND	74	+3V3
75	GND		

2.4.10 M.2 Socket on MezIO™ Module

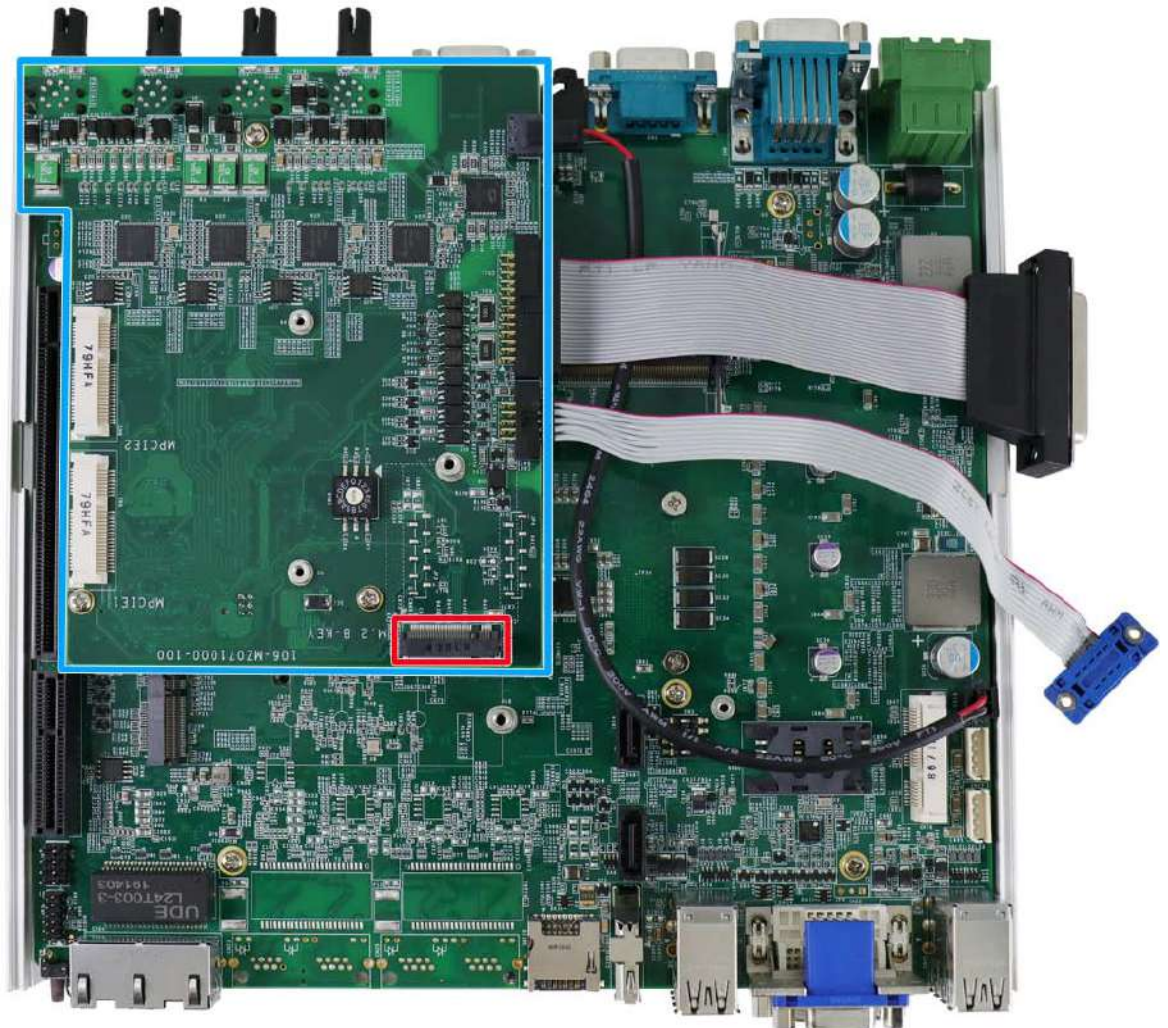

There is an additional M.2 2242 slot available on the MezIO™ module. To expand wireless networking capability, users can install off-the-shelf 3G/ 4G mini-PCIe modules and access the internet via the provider’s network.

For wireless (3G/ 4G) communication, multiple SMA antenna apertures can be located on the front and rear panel.

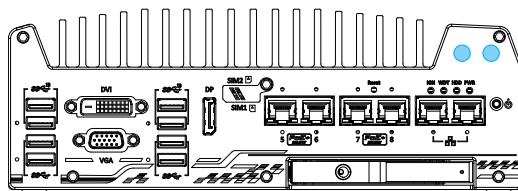

Front panel antenna opening

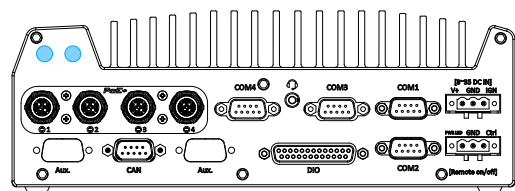

Rear panel antenna opening

M.2 (B Key) Slot Pin Definition

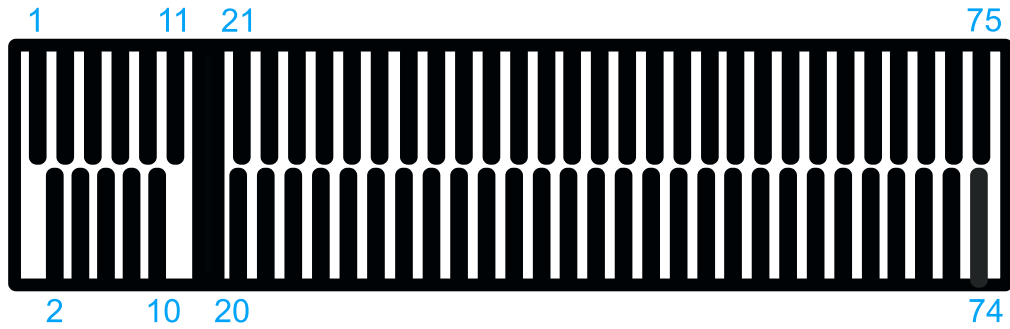

Pin #	Signal	Pin #	Signal
1	-	2	+3V3
3	GND	4	+3V3
5	GND	6	FULL_CARD_POWER_OFF_N
7	USB_D+	8	W_DISABLE_N
9	USB_D-	10	-
11	GND		
Mechanical Key			
21	-	20	-
23	-	22	-
25	-	24	-
27	GND	26	-
29	USB3.0-RX-	28	-
31	USB3.0-RX+	30	UIM1-RESET
33	GND	32	UIM1-CLK
35	USB3.0-TX-	34	UIM1-DATA
37	USB3.0-TX+	36	UIM1-PWR
39	GND	38	-
41	PERn0 / SATA-B+	40	UIM2-DET
43	PERp0 / SATA-B-	42	UIM2-DATA
45	GND	44	UIM2-CLK
47	PETn0 / SATA-A-	46	UIM2-RST
49	PETp0 / SATA-A+	48	UIM2-PWR
51	GND	50	PERST_N
53	REFCLKN	52	-
55	REFCLKP	54	-
57	GND	56	-
59	-	58	-
61	-	60	-
63	-	62	-
65	-	64	-
67	RESET_N	66	UIM1_DETECT
69	CONFIG_1	68	-
71	GND	70	+3V3
73	GND	72	+3V3
75	-	74	+3V3

2.4.11 mini-PCIe Socket on MezIO™ Module

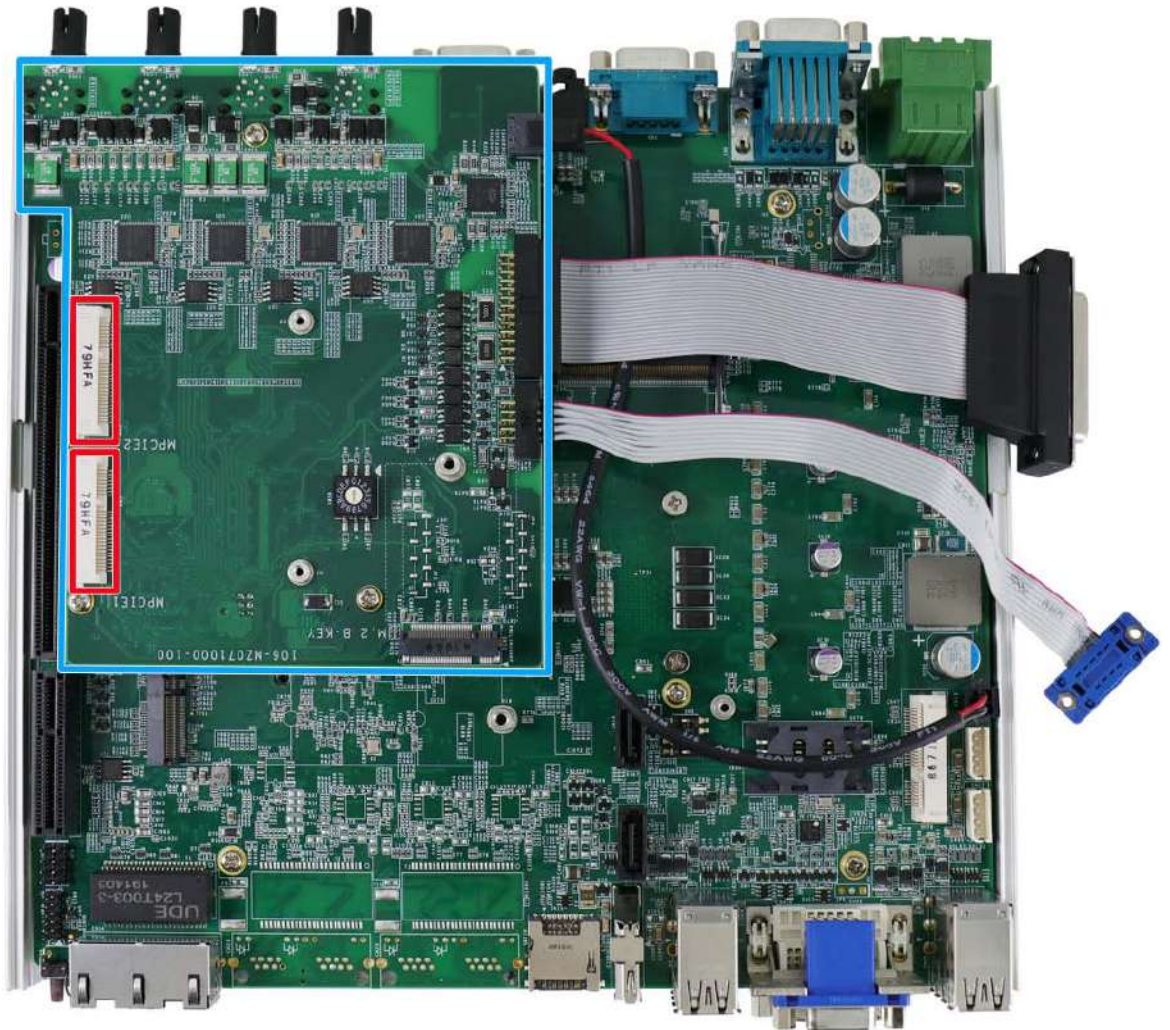

There are two additional full-size mini-PCIe sockets available on the MezIO™ module. They are implemented with USB signals only have better compatibility with off-the-shelf 3G/ 4G mini-PCIe modules. For customers who want to install 3G/ 4G module(s), please take advantage of these two mini-PCIe sockets and the associated SIM slots.

For wireless (3G/ 4G) communication, multiple SMA antenna apertures can be located on the front and rear panel.

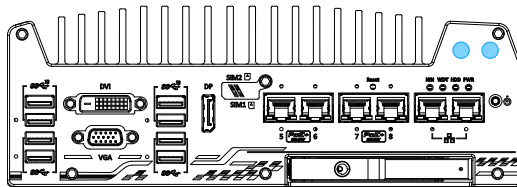

Front panel antenna opening

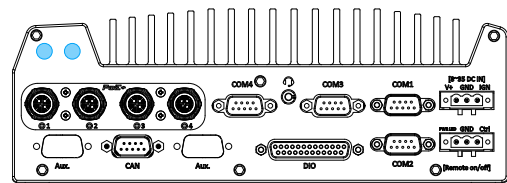

Rear panel antenna opening

mini-PCle Slot Pin Definition

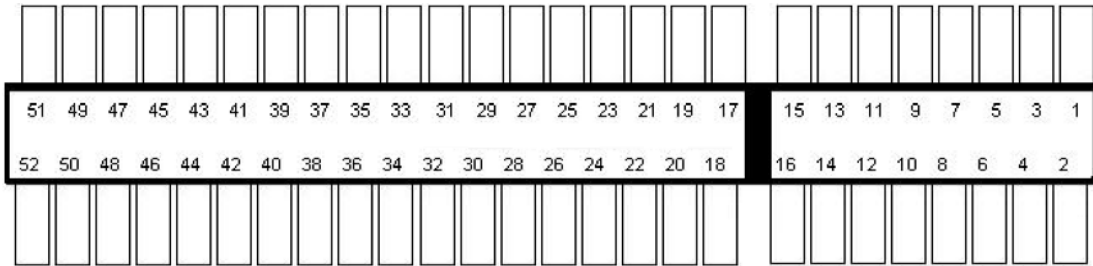

Pin #	Signal	Pin #	Signal
1	Reserved	2	+3.3Vaux
3	Reserved	4	GND
5	Reserved	6	+1.5V
7	Reserved	8	UIM PWR
9	GND	10	UIM DATA
11	Reserved	12	UIM CLK
13	Reserved	14	UIM RESET
15	GND	16	UIM VPP
Mechanical Key			
17	Reserved	18	GND
19	Reserved	20	W DISABLE#
21	GND	22	PERST#
23	Reserved	24	+3.3Vaux
25	Reserved	26	GND
27	GND	28	+1.5V
29	GND	30	Reserved
31	Reserved	32	Reserved
33	Reserved	34	GND
35	GND	36	USB D-
37	GND	38	USB D+
39	+3.3Vaux	40	GND
41	+3.3Vaux	42	LED WWAN#
43	GND	44	LED WLAN#
45	Reserved	46	LED WPAN#
47	Reserved	48	+1.5V
49	Reserved	50	GND
51	Reserved	52	+3.3Vaux

2.4.12 Ignition Switch on MezIO™ Module (Nuvo-7100/ 7200/ 7250VTC only)

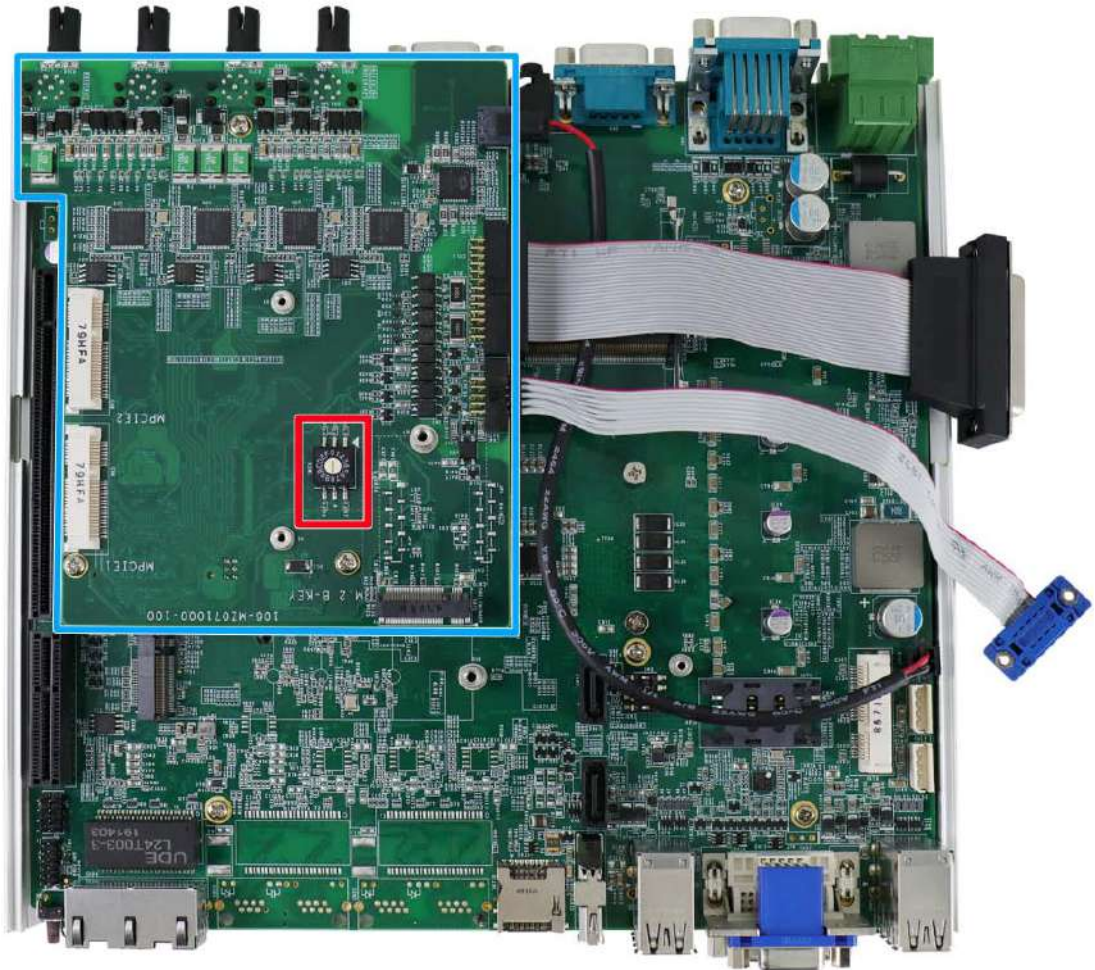

For Nuvo-7100/ 7200/ 7250VTC systems, the ignition control switch can be found within the enclosure, on the MezIO™ module. The ignition power control switch features multiple modes for pre and post ignition settings. Please refer to the section [Ignition Power Control](#) for details.

2.4.13 MezIO™ Interface & Pin Definition

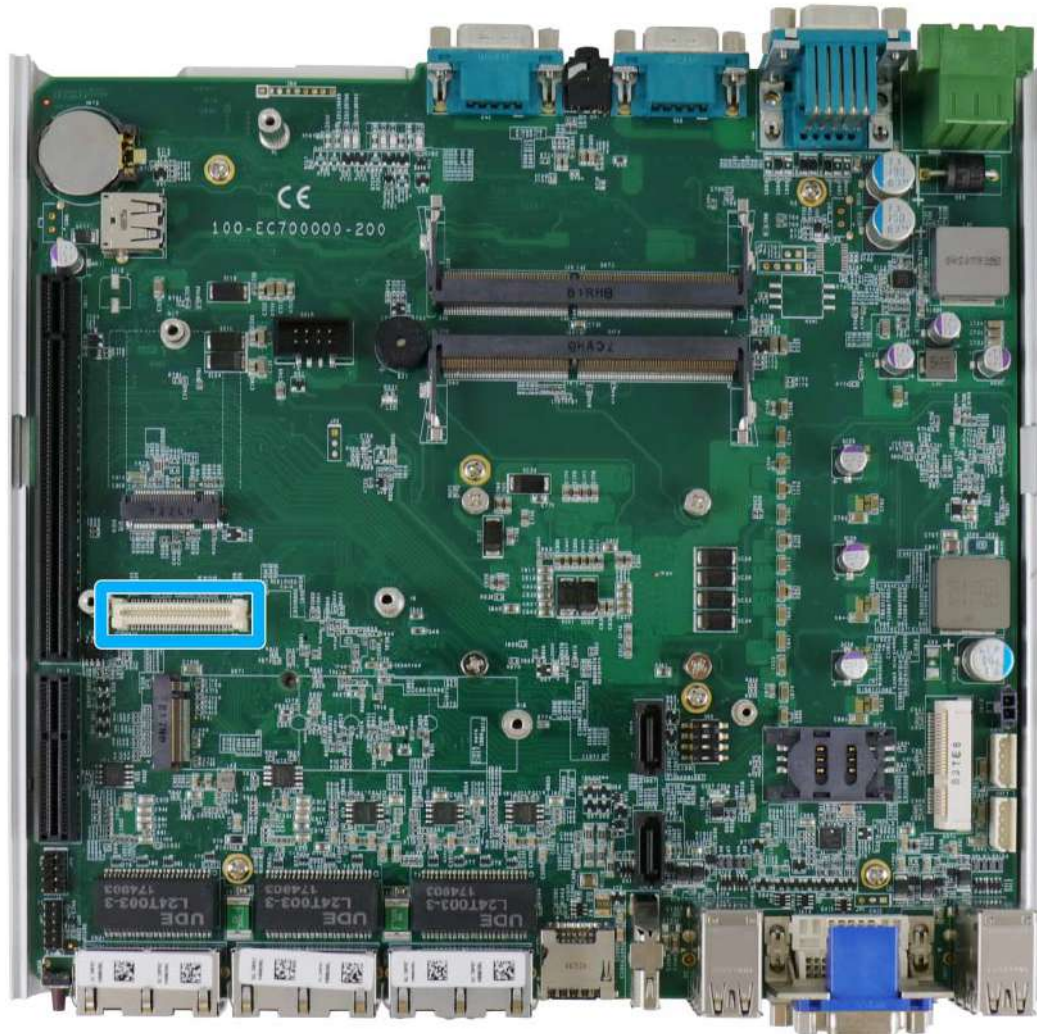

MezIO™ is an innovative interface designed for integrating application-oriented I/O functions into an embedded system. It offers computer signals, power rails and control signals via a high-speed connector. MezIO™ is also mechanically reliable benefited from its 3-point mounted mezzanine structure. A MezIO™ module can leverage these signals to implement comprehensive I/O functions.

The system incorporates MezIO™ interface and universal mechanical design to accommodate Neosys' standard MezIO™ modules. For customers who want to develop their own MezIO™ module, Neosys provides MezIO™ design documents on a NDA basis. Please contact Neosys for further information.

MezIO™ Interface Pin Definition

MezIO™ interface leverages FCI BergStak® board-to-board connector to provide interconnectivity of high-speed signals. The receptacle part on the PCBA is FCI 61082-063402LF while the plug part on the MezIO™ module is FCI 61083-064402LF. Please refer to the following table for signal definition of its 60-pin connector.

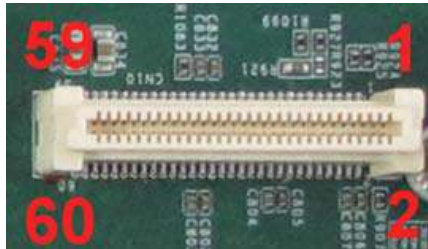

Function Description	Signal	Pin#	Pin#	Signal	Function Description
Reserved	Reserved	1	2	PCIE_TXP_0	PCIe data pair
Reserved	Reserved	3	4	PCIE_TXN_0	PCIe data pair
Reserved	Reserved	5	6	GND	Ground
Reserved	Reserved	7	8	PCIE_RXP_0	PCIe data pair
System S4 signal	SLP_S4#	9	10	PCIE_RXN_0	PCIe data pair
Ground	GND	11	12	CLK100_P_0	PCIe clock pair
Reserved	Reserved	13	14	CLK100_N_0	PCIe clock pair
Ground	GND	15	16	GND	Ground
Reserved	UID_LED	17	18	PCIE_TXP_1	PCIe data pair
Platform reset	PLT_RST#	19	20	PCIE_TXN_1	PCIe data pair
USB data pair	USBP5_N	21	22	PCIE_RXP_1	PCIe data pair
USB data pair	USBP5_P	23	24	PCIE_RXN_1	PCIe data pair
Ground	GND	25	26	GND	Ground
SMB bus	SMB_DATA	27	28	CLK100_P_1	PCIe clock pair
SMB bus	SMB_CLK	29	30	CLK100_N_1	PCIe clock pair
PCIe data pair	PCIE_TXP_3	31	32	GND	Ground
PCIe data pair	PCIE_TXN_3	33	34	PCIE_TXP_2	PCIe data pair
Ground	GND	35	36	PCIE_TXN_2	PCIe data pair
PCIe data pair	PCIE_RXP_3	37	38	GND	Ground
PCIe data pair	PCIE_RXN_3	39	40	PCIE_RXP_2	PCIe data pair
Power button	PWRBTN#	41	42	PCIE_RXN_2	PCIe data pair
Reserved	Reserved	43	44	RXD4	SIO COM4
PCH GPIO	GPIO_RISER3	45	46	TXD4	SIO COM4
PCH GPIO	GPIO_RISER2	47	48	RXD5	SIO COM5
PCH GPIO	GPIO_RISER1	49	50	TXD5	SIO COM5
Ground	GND	51	52	GND	Ground
3.3V power	P3V3	53	54	P1V8	1.8V power
3.3V power	P3V3	55	56	GND	Ground
5V power	P5V	57	58	P12V	12V power
5V power	P5V	59	60	P12V	12V power

3 System Installation

Before disassembling the system enclosure and installing components and modules, please make sure you have done the following:

- It is recommended that only qualified service personnel should install and service this product to avoid injury or damage to the system.
- Please observe all ESD procedures at all times to avoid damaging the equipment.
- Before disassembling your system, please make sure the system has powered off, all cables and antenna (power, video, data, etc.) are disconnected.
- Place the system on a flat and sturdy surface (remove from mounts or out of server cabinets) before proceeding with the installation/ replacement procedure.

3.1 Disassembling the System

To access system internal components, the system needs to be disassembled. To disassemble the system enclosure, you need to remove the Cassette module and screws on both I/O panels.

1. Turn the system upside-down and remove the four screws at the bottom of the Cassette module.



NOTE

Not applicable to Nuvo-7100VTC/ Nuvo-7104VTC/ Nuvo-7108VTC systems.



2. Gently wiggle and separate the Cassette module from the system.



NOTE

Not applicable to Nuvo-7100VTC/ Nuvo-7104VTC/ Nuvo-7108VTC systems.



3. On the front I/O panel, remove the hexa-screws indicated below.



Nuvo-7200/ Nuvo-7250VTC series systems



Nuvo-7100VTC series systems

4. Remove the front I/O panel.

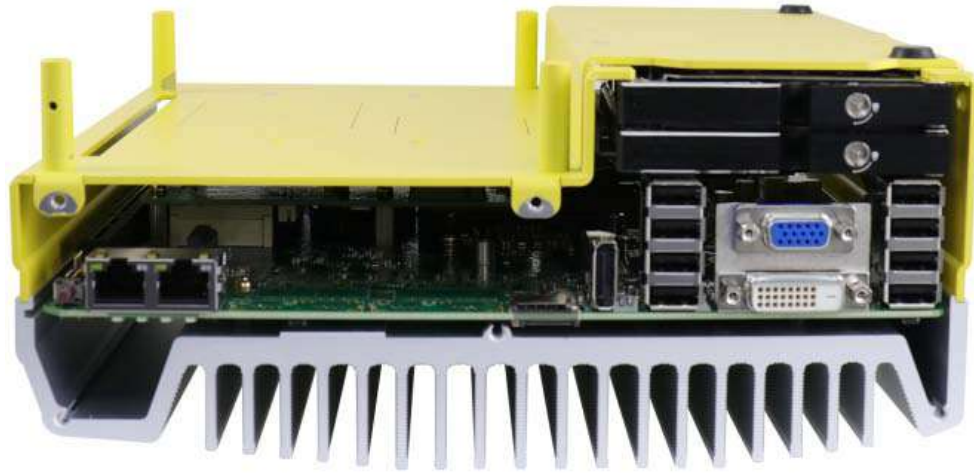

Nuvo-7200/ Nuvo-7250VTC series systems



Nuvo-7100VTC series systems

- On the rear I/O panel, remove the hexa-screws indicated below.



Nuvo-7200/ Nuvo-7250VTC series systems



Nuvo-7100VTC series systems

6. Remove the rear I/O panel.

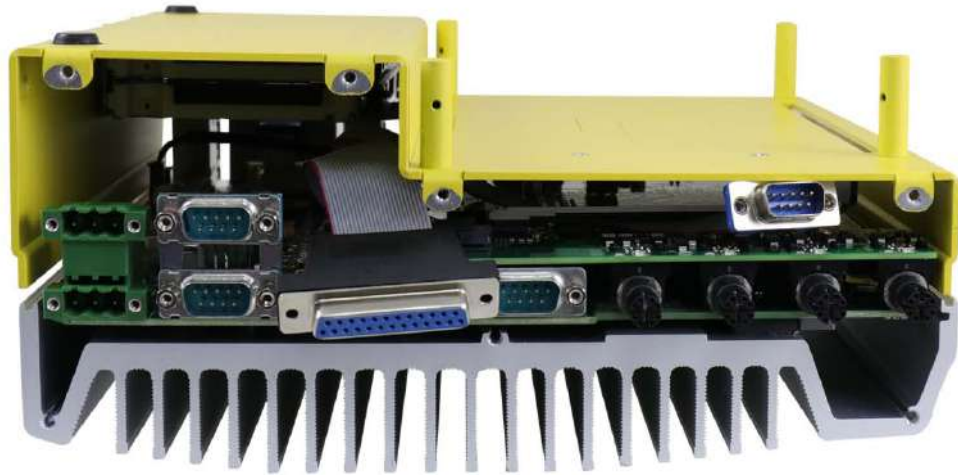

Nuvo-7200/ Nuvo-7250VTC series systems



Nuvo-7100VTC series systems

7. Gently lift the system's bottom panel.

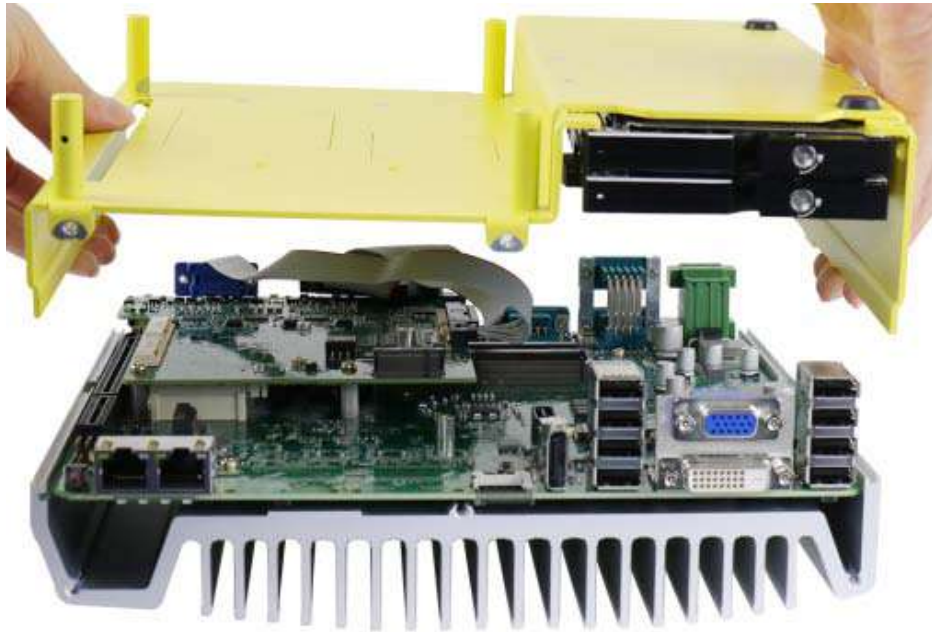

Nuvo-7200/ Nuvo-7250VTC series systems

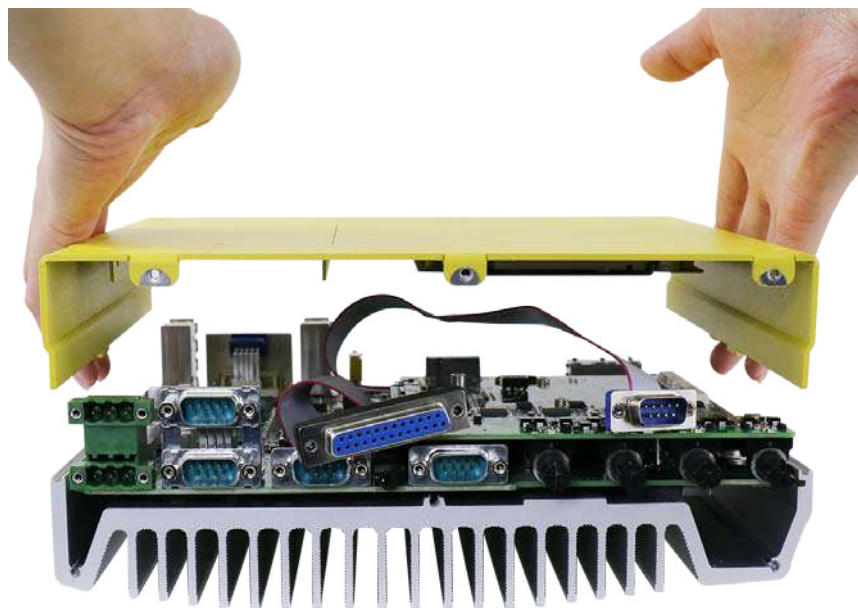

Nuvo-7100VTC series systems



NOTE

Please disengage the 22-pin SATA cable connected to the 2.5" hot swappable tray before removing the bottom panel.

8. Once the bottom panel has been removed, you need to remove the MezIO™ module before you have complete access to the system's internal I/O interfaces. To remove the MezIO™ module, unscrew the three screws and unclip the power cable indicated, as shown in the image below. Gently lift and separate the MezIO™ module from the motherboard.

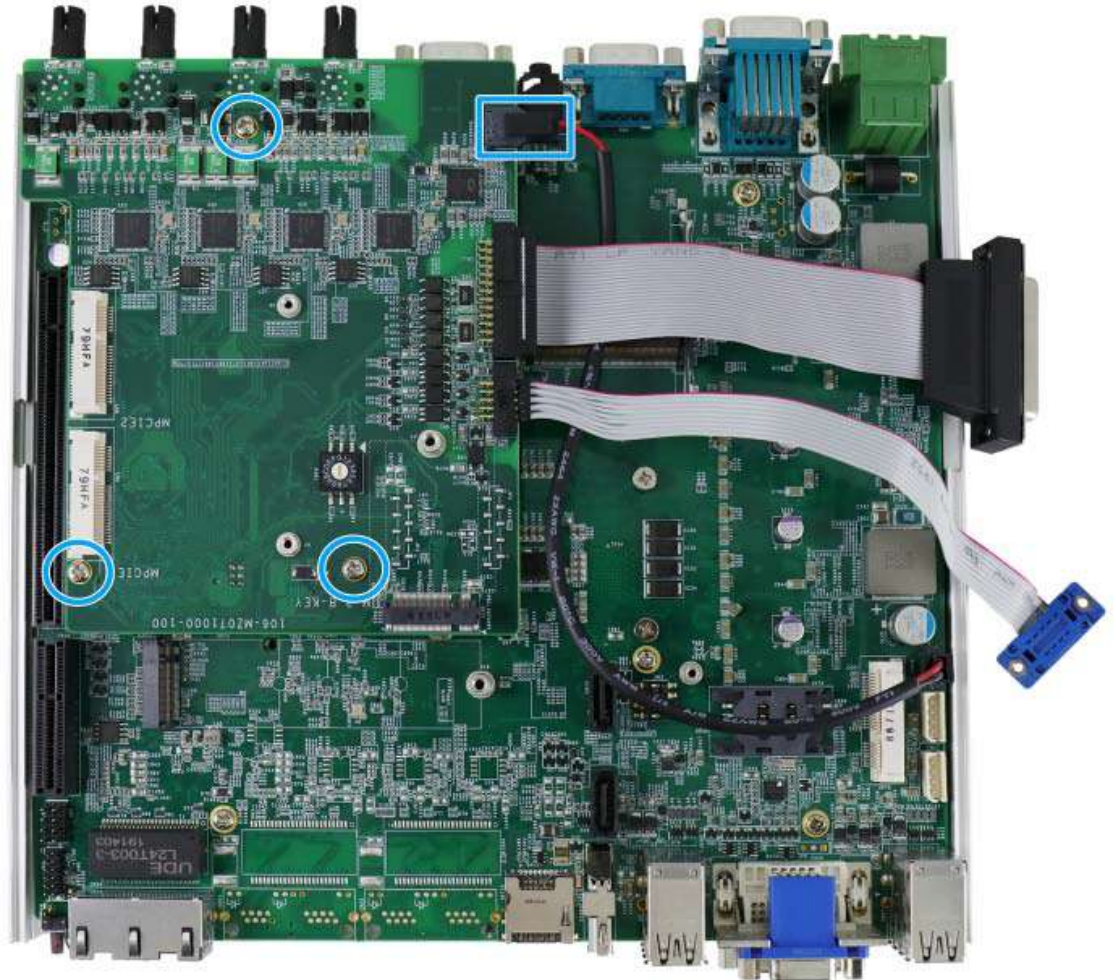

9. Once the MeziOTM module has been removed, you should have complete access to the internal expansion interfaces.

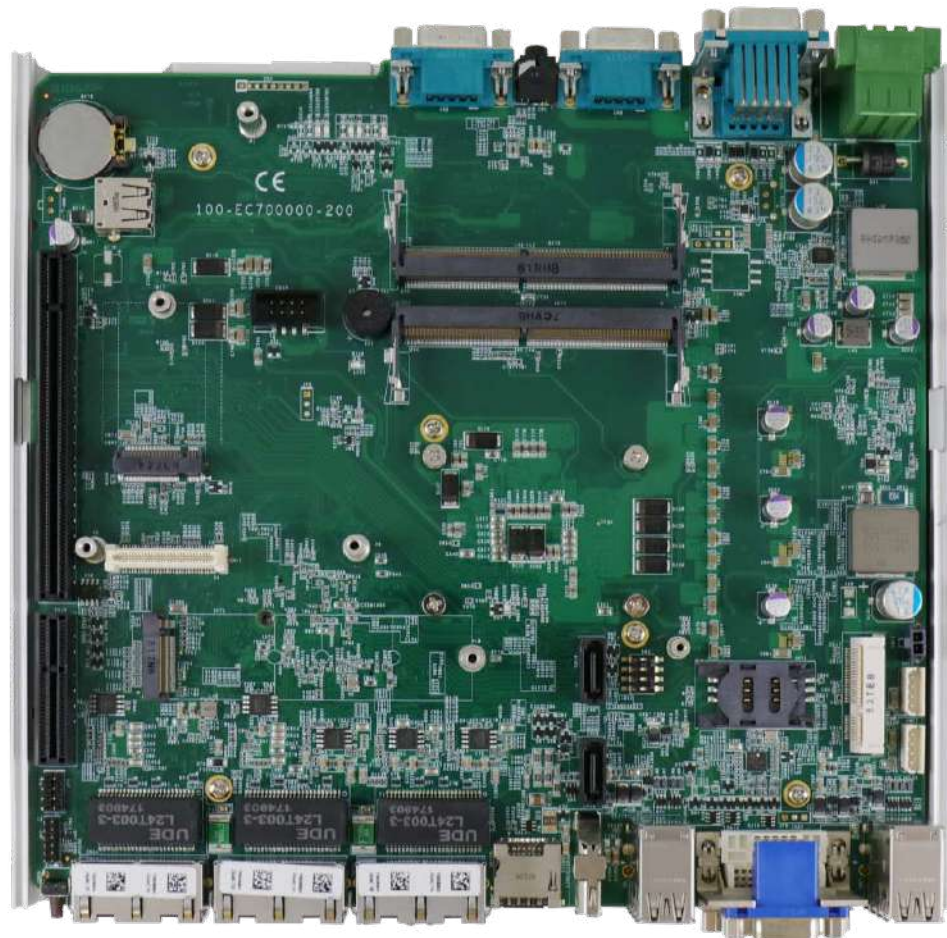

3.2 Installing Internal Components

3.2.1 CPU Installation Procedure

1. To install the CPU, you will need to separate the heatsink and the motherboard.
2. To do so, remove the nine screws indicated below (if you are installing the CPU for the first time, you need not remove the screws indicated in **red** as they are not yet installed and the screws can be found in the accessory box).

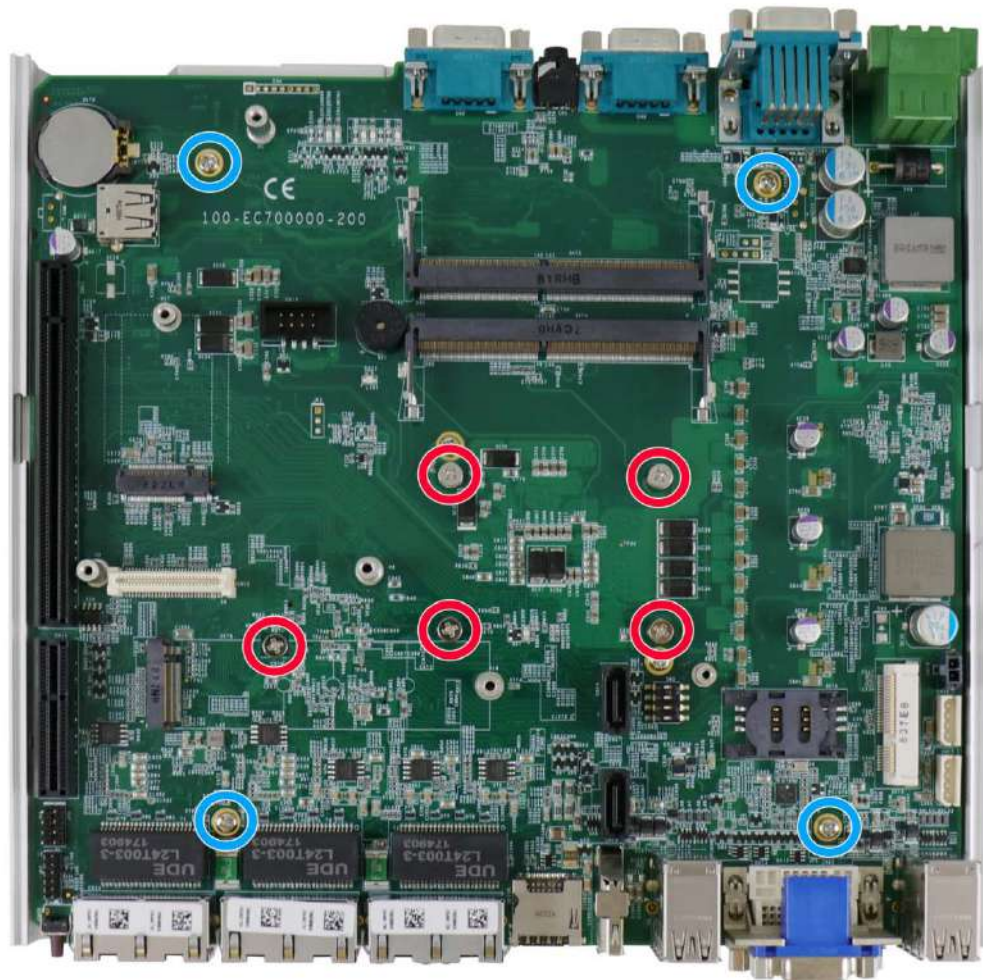

3. Gently separate the motherboard from the heatsink, you'll see the CPU socket protective cover, place finger tips underneath the sign "REMOVE" for leverage and gently lift the cover.

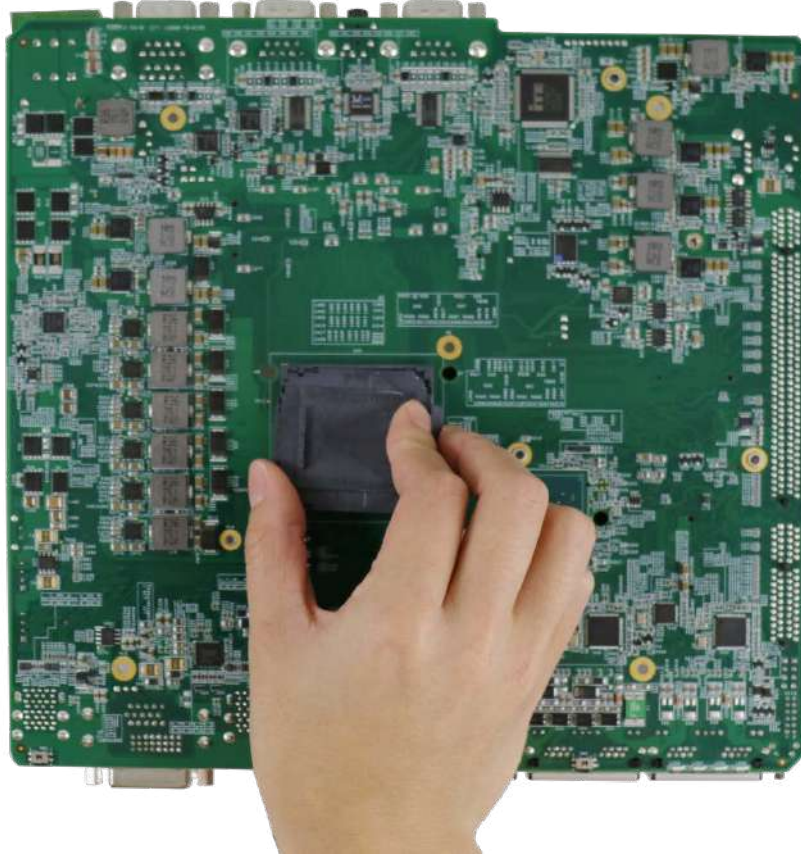

 **WARNING**

With the protective cover removed, please be careful when handling the motherboard. DO NOT touch the pins in the LGA socket!

4. Remove the CPU from its container/ tray. Match the two notches on the side to the protrusions in the socket, gently lower the CPU into the socket.



5. Locate the CPU retention bracket from the accessory box. Place the retention bracket on the CPU and hold it in place.



6. Turn the motherboard around and secure the bracket by tightening two M3 P-head screws.

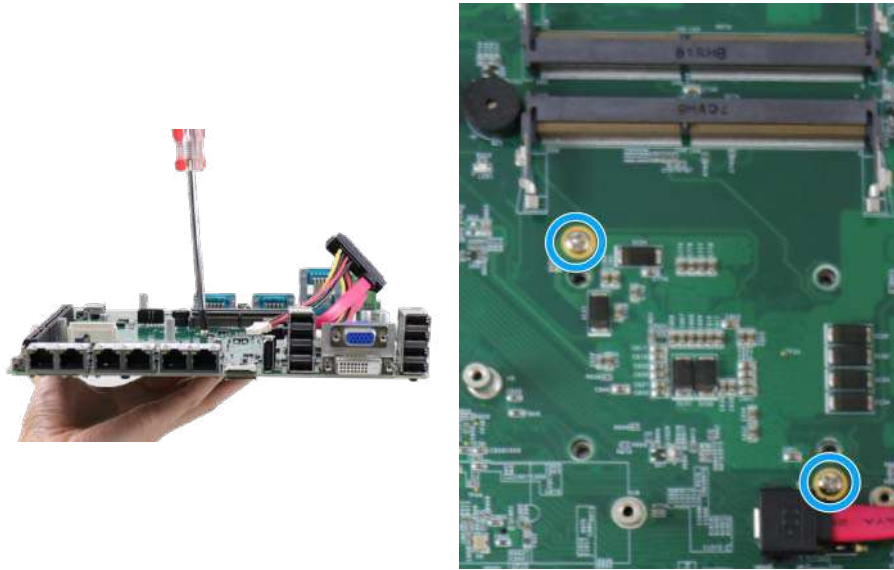

Hold CPU bracket firmly and turn the motherboard around

Secure two M3 P-head screws

7. Remove all thermal pads' protective films on the heatsink.

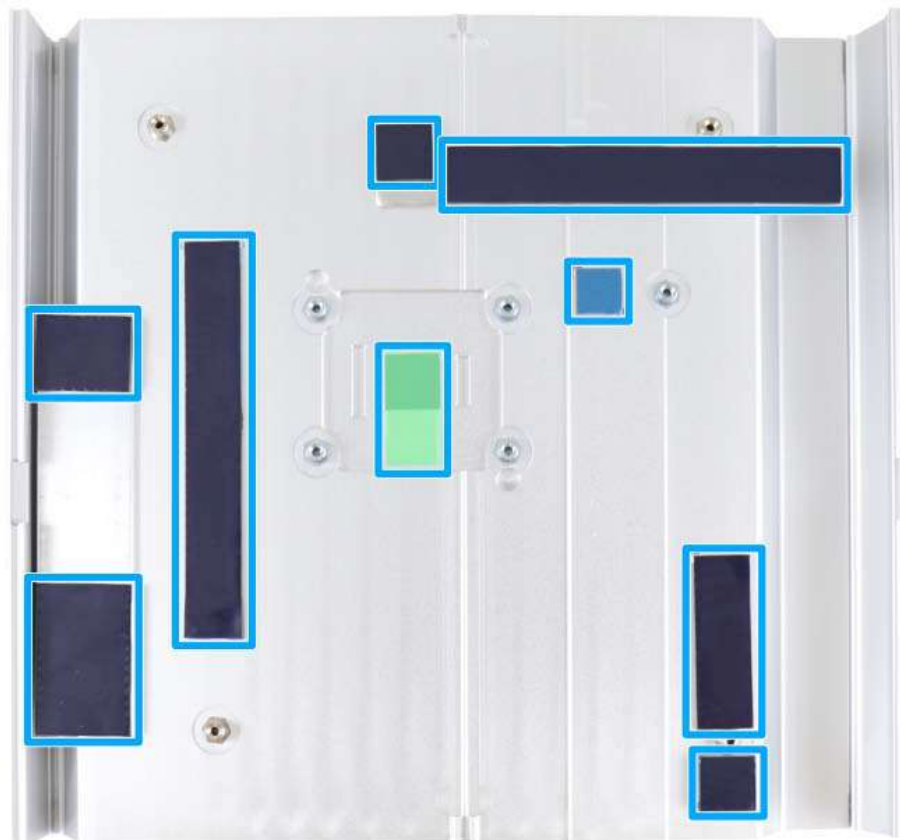

8. With the four motherboard standoffs aligned, gently lower the motherboard onto the heatsink and secure the four screws.

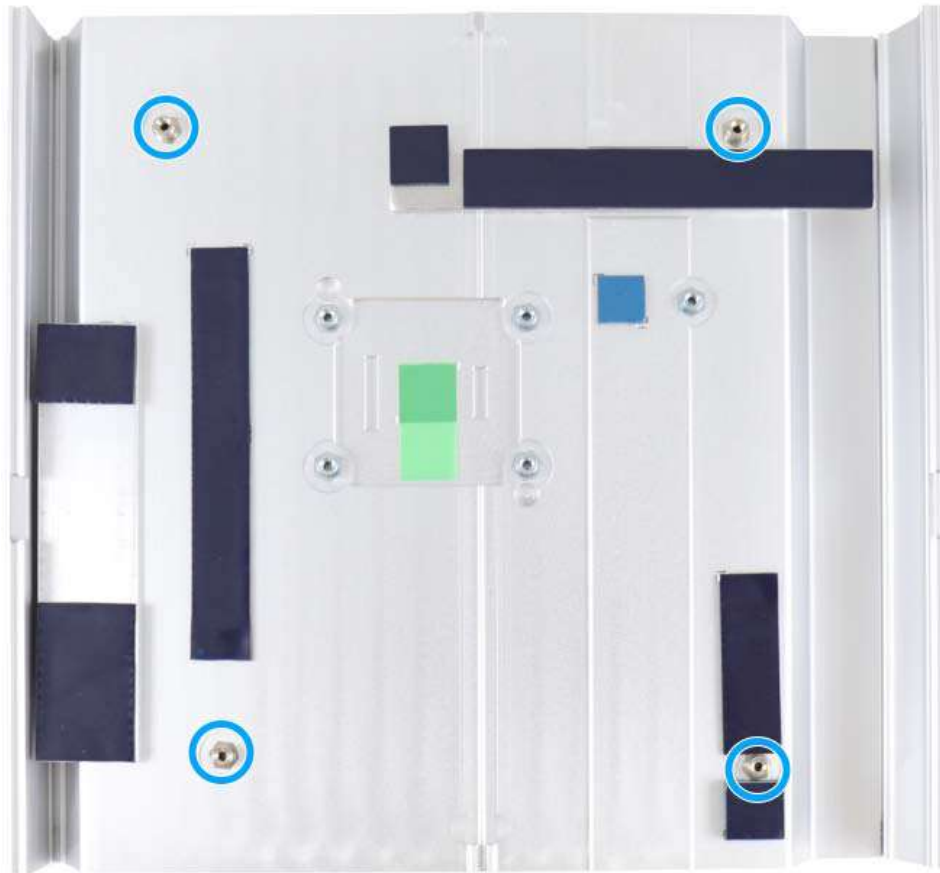

9. Once the motherboard has been installed, you're ready to secure the five screws that help the heatsink apply pressure to the CPU/ chipset die. You'll want to apply even pressure to the corners by gradually tightening each screw. Please refer to the recommended order when tightening the screws.

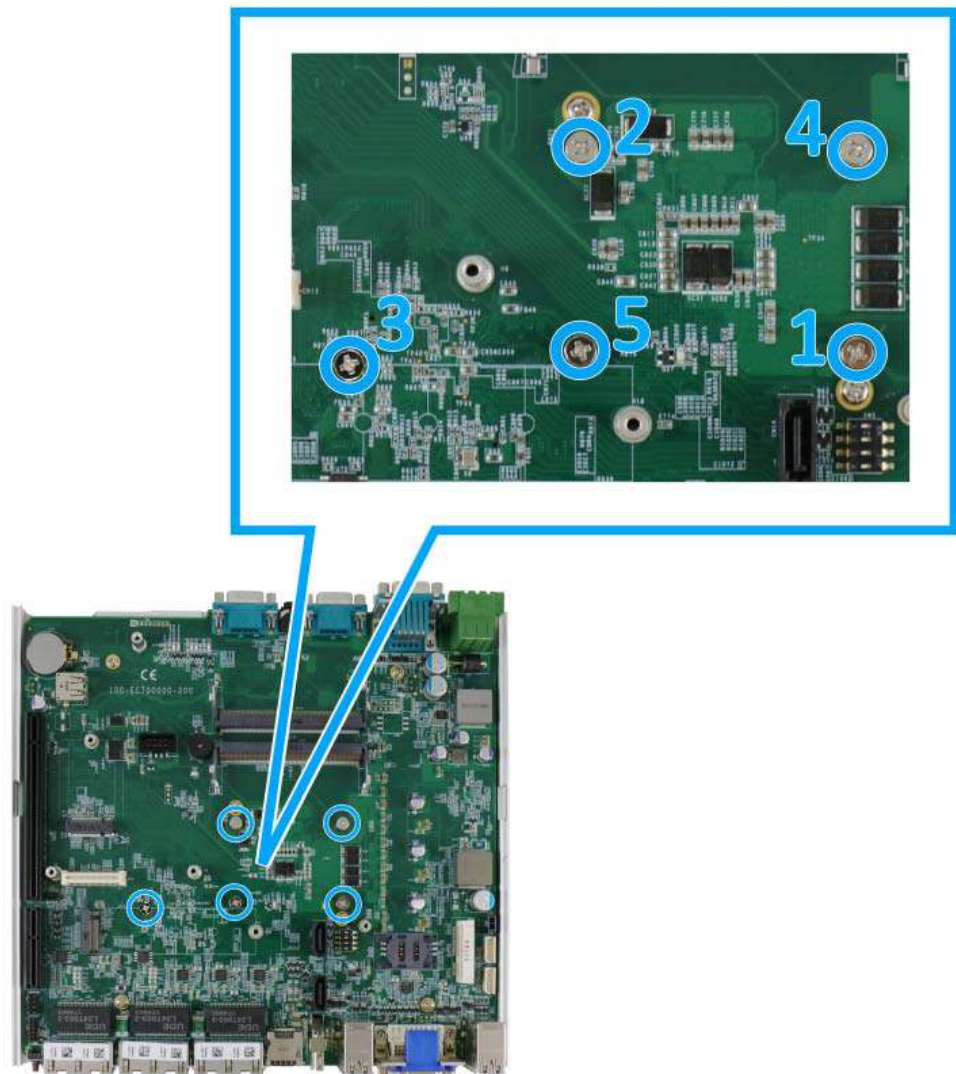

10. [Reinstall the system enclosure](#) and Cassette module when done.
11. If you need to install other components, please refer to respective sections.

3.2.2 DDR4 SO-DIMM Installation

There are two SO-DIMM memory slots (indicated in **blue**) on the motherboard that supports a total maximum of 32GB DDR4-2666. Please follow the procedures below to replace or install the memory modules.

1. Please refer to the section “[Disassembling the System](#)”.
2. Locate the SODIMM memory module slots on the motherboard.

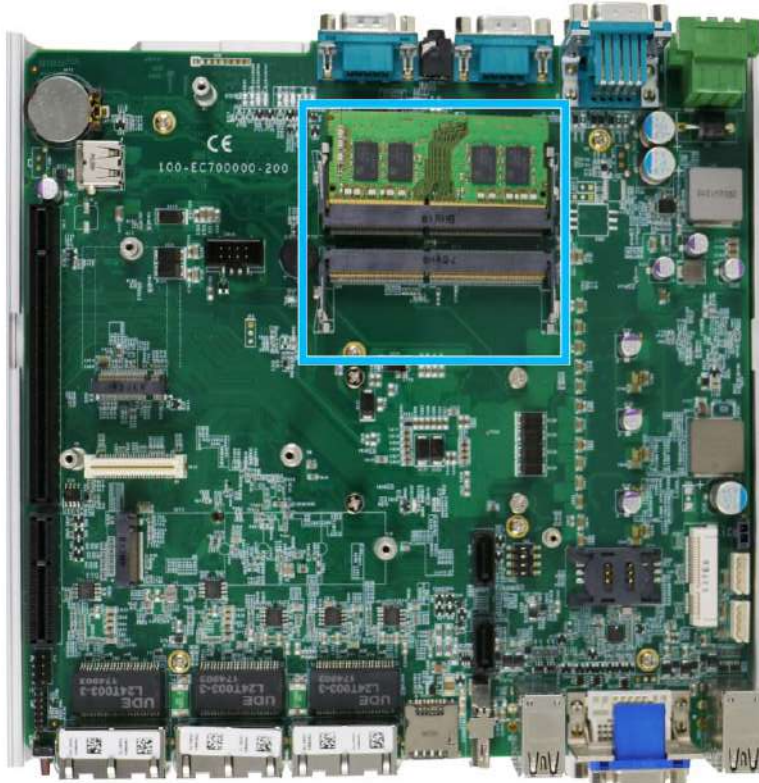

3. To install the memory module, insert gold fingers into the slot at 45-degree angle, push down on the memory module to clip the module into position.



4. Push the memory module down until it is clipped-in.



5. Repeat steps 3 and 4 to install the other module.
6. [Reinstall the system enclosure](#) and panel when done.
7. If you need to install other components, please refer to respective sections.

3.2.3 mPCIe Module, Mini-SIM (2FF) Card and Antenna Installation

The system has an mPCIe slot (indicated in **blue**) coupled with Mini-SIM socket (indicated in **red**) for installing 3G/ 4G module. For installation, please refer to the following instructions.

1. Please refer to the section "[Disassembling the System](#)".
2. Locate the mPCIe and SIM card slots on the motherboard. The MezIO™ module's SIM card slot can be found underneath the MezIO™ mini-PCIe slot

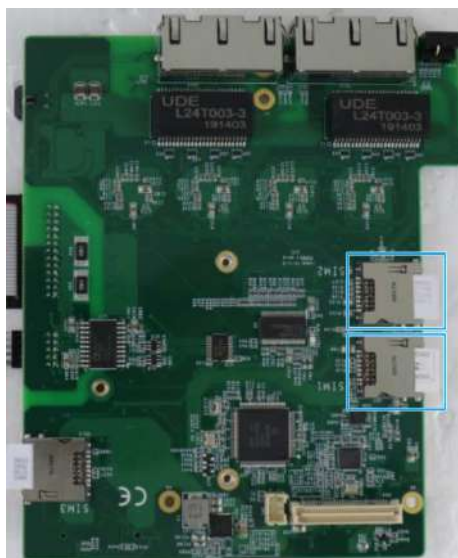
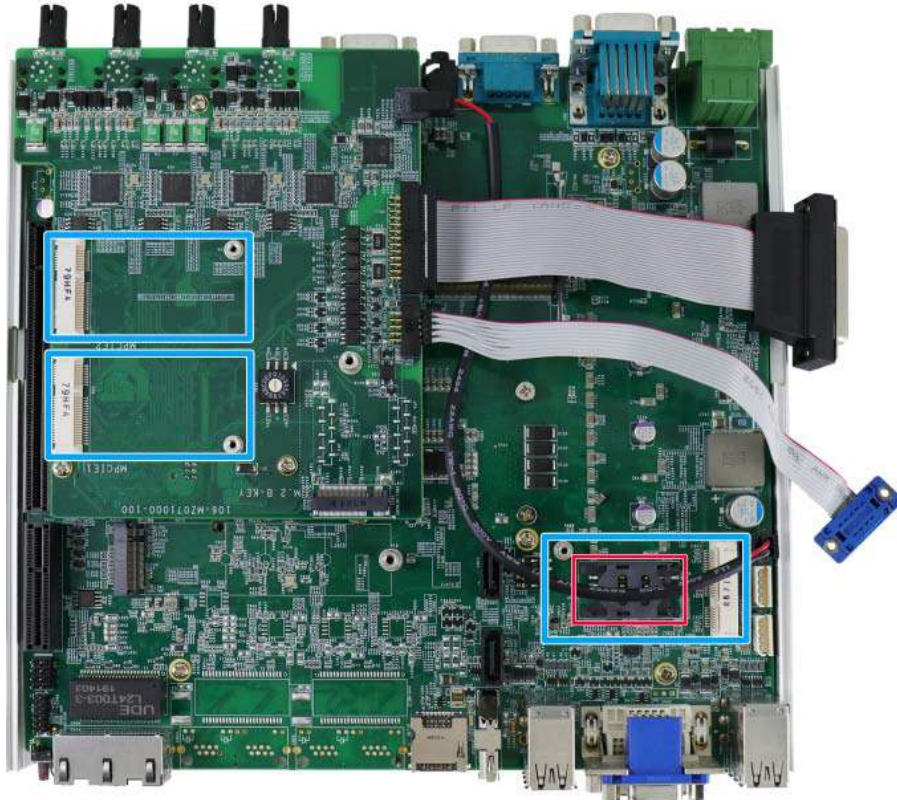

SIM slots underneath the mini-PCIe slots on MezIO™ module

- Before installing the mPCIe module, you need to insert the Mini-SIM card. Slide the SIM slot holder and lift the SIM card holder. Insert the Mini-SIM card (pins facing up), shut the SIM holder and slide it to lock the SIM card in-place.

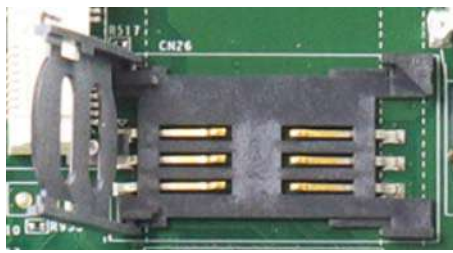

Slide and lift SIM card holder

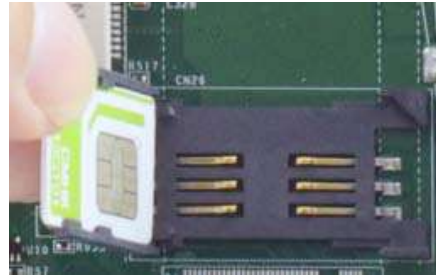

Insert Mini-SIM card with pins facing up

- Secure the Mini-SIM card by sliding the holder.



- Insert the mPCIe module on a 45 degree angle into the mPCIe slot and secure the module.



Insert on 45 degree angle



Secure the module

- Clip on the IPEZ-to-SMA cable to the module and secure the antenna to the front or rear panel. Please refer to the module's manual for clip-on connection.

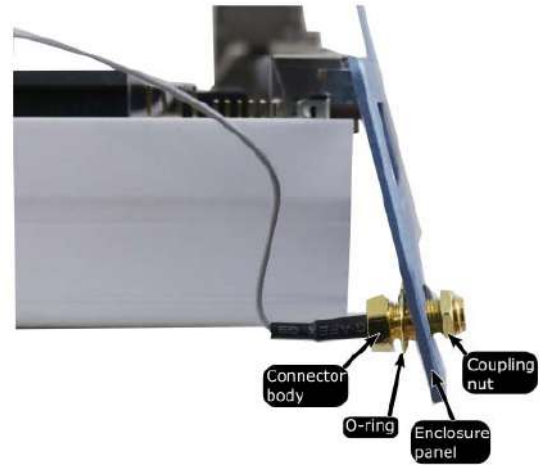

Clip on IPEZ-to-SMA cable

Secure antenna to rear panel

- [Reinstall the system enclosure](#) and panel when done.
- If you need to install other components, please refer to respective sections.

3.2.4 M.2 2242 (B Key) Module and Micro-SIM (3FF) Card Installation



NOTE

The dual SIM card functionality is only available when Sierra Wireless EM7455/ 7430 solution is installed. For other 4G add-on solutions, SIM card 1 slot is the default functioning slot.

The system has an M.2 slot (indicated in **blue**) for installing 3G/ 4G or a WiFi module that can be coupled with dual Micro-SIM card slots (indicated in **red**). For installation, please refer to the following instructions.

1. Please refer to the section "[Disassembling the System](#)".
2. Locate the M.2 2242 (B Key) and SIM card slots on the motherboard. The MeziO™ module's SIM card slot can be found underneath the MeziO™ M.2 slot.



M.2 slot on MeziO™ module

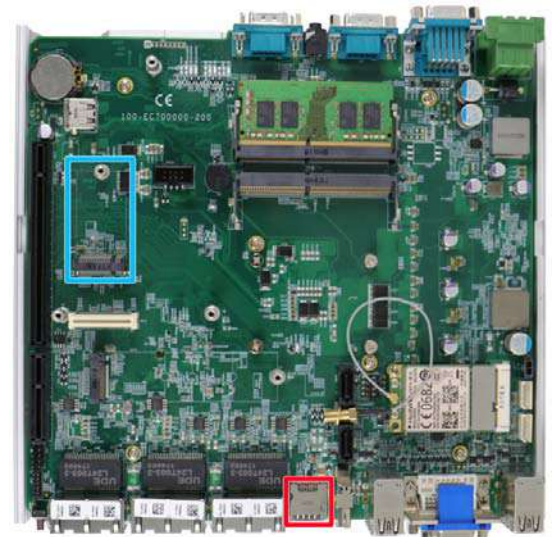

M.2 and SIM slot on motherboard

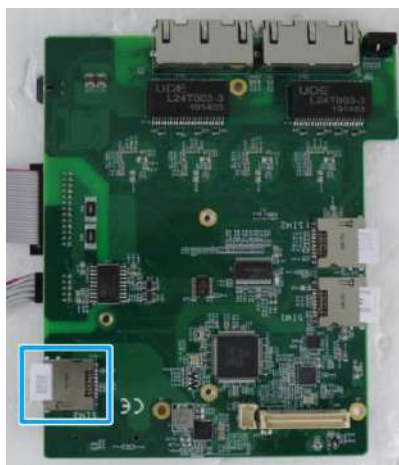

SIM slot underneath the M.2 slot on MeziO™ module

3. Insert the module on a 45 degree angle.



4. Gently press down and secure the module with an M2.5 P-head screw.



5. Clip on the IPEZ-to-SMA cable to the module and secure the antenna to the front or rear panel. Please refer to the module's manual for clip-on connection.

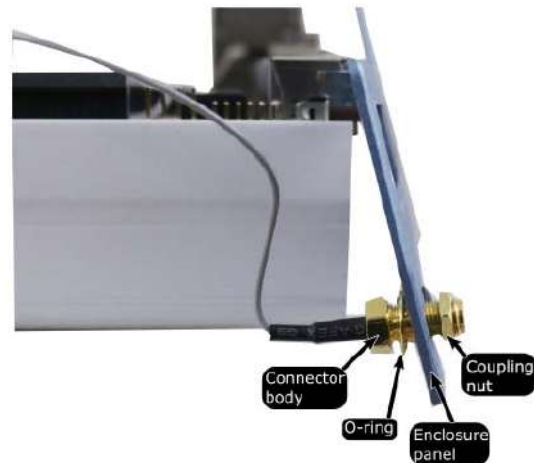

Clip on IPEZ-to-SMA cable

Secure antenna to rear panel

6. With the motherboard exposed, the SIM card is inserted with the gold fingers facing downward. If you are inserting the SIM card with the system upright (heatsink fins upwards), the gold fingers should be facing upward. The SIM socket utilizes push-push mechanism (push-to-install and push-to-retrieve). For SIM card insertion on the MezIO™ module, please refer to the SIM card slot location illustration.

7. If you wish to swap or add SIM card via the front panel, you will need to loosen the screw indicated in the illustration below to gain access to the SIM card slots.

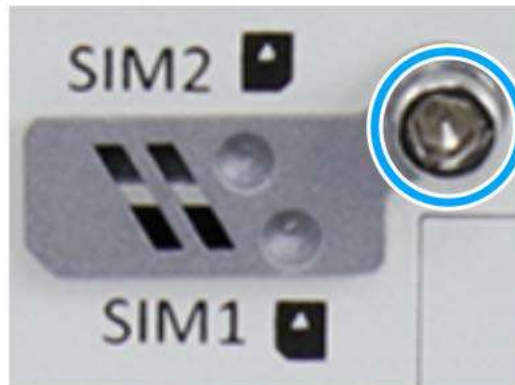

8. [Reinstall the system enclosure](#) and panel when done.
9. If you need to install other components, please refer to respective sections.

3.2.5 M.2 2280 NVMe SSD or Intel® Optane™ Memory Installation

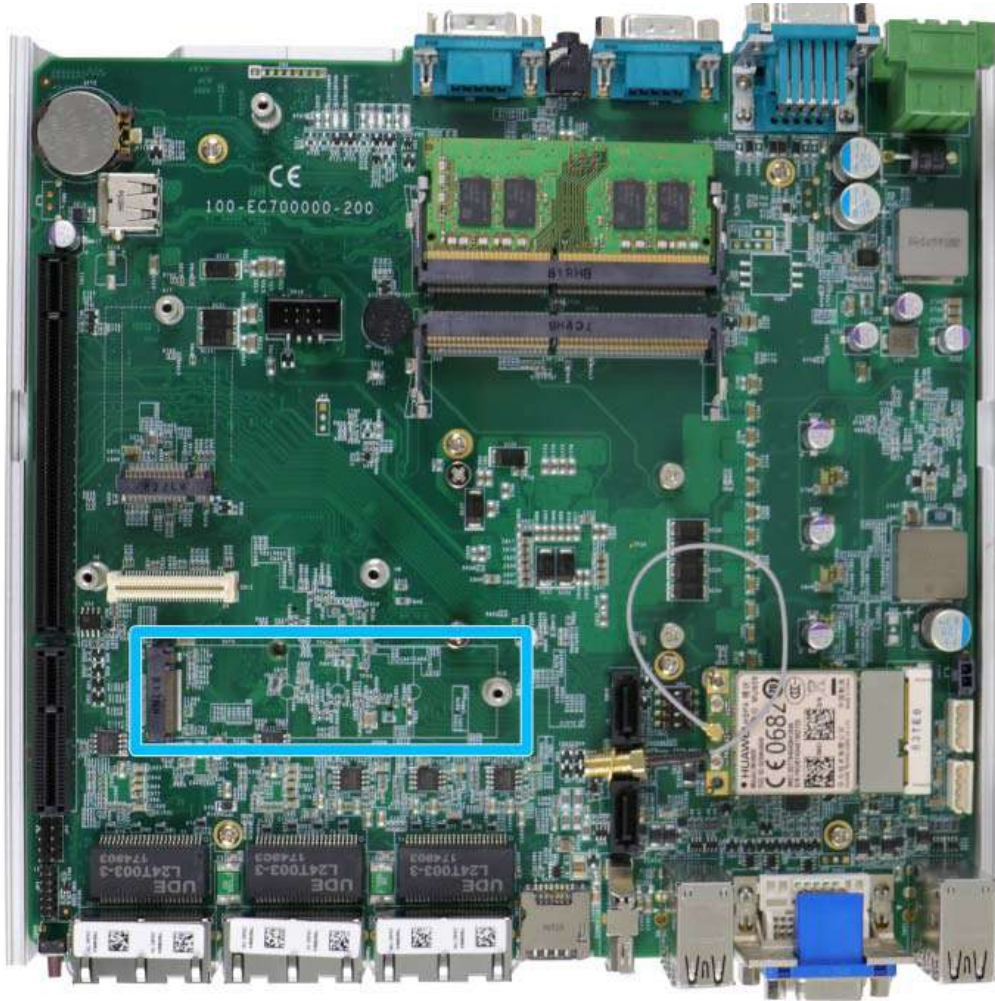

The system has a x4 PCIe M.2 2280 slot for you to install an NVMe SSD for the ultimate performance or an Intel® Optane™ memory to accelerate the read/ write performances of traditional hard disk drive. An NVMe SSD offers exceptional performance over 2.5" SSDs while Intel® Optane™ memory can dramatically boost your traditional hard disk drives' read/ write performances. For installation, please refer to the following instructions.

1. Please refer to the section "[Disassembling the System](#)", you may not need to completely dismantle the system to gain access to the M.2 slot.
2. Insert the module on a 45 degree angle.



3. Gently press down and secure the module with an M2.5 P-head screw.



4. [Reinstall the system enclosure](#) and panel when done.
5. If you need to install other components, please refer to respective sections.
6. Please refer to the section [Intel® Optane™ Memory BIOS Setup and Driver Installation](#) for traditional hard drive acceleration.

3.2.6 MezIO™ Module Installation

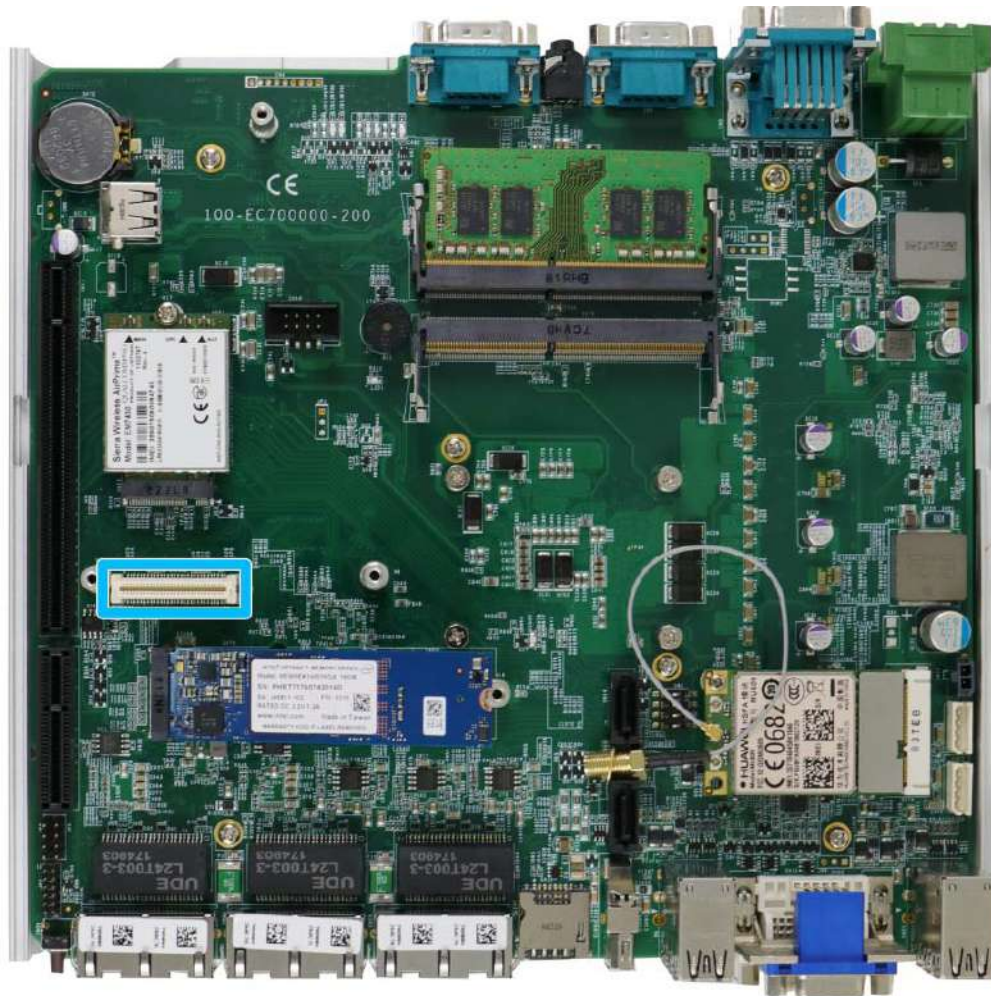

MezIO™ is an innovative interface designed for integrating application-oriented I/O functions into an embedded system. It offers computer signals, power rails and control signals via a high-speed connector. MezIO™ is also mechanically reliable benefited from its 3-point mounted mezzanine structure. A MezIO™ module can leverage these signals to implement comprehensive I/O functions.

The system incorporates MezIO™ interface and universal mechanical design to accommodate Neosys' standard MezIO™ modules. For customers who want to develop their own MezIO™ module, Neosys provides MezIO™ design documents on a NDA basis. Please contact Neosys for further information.

1. Please refer to the section "[Disassembling the System](#)" to gain access to the MezIO™ interface.

2. The MeziO™ module is secured by the three stand-mounts indicated in the illustration below.

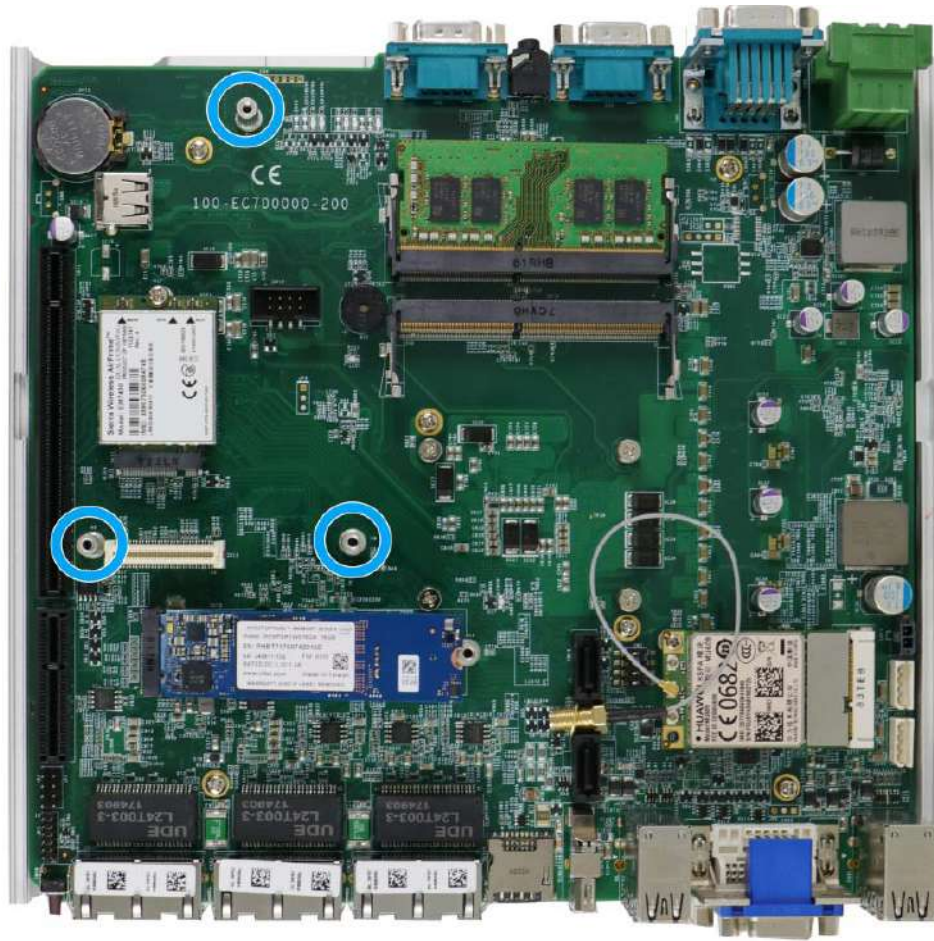

3. Gently lower the MezIO™ module onto the three stand-mounts while matching the MezIO™ interface. Secure the module using three screws supplied.

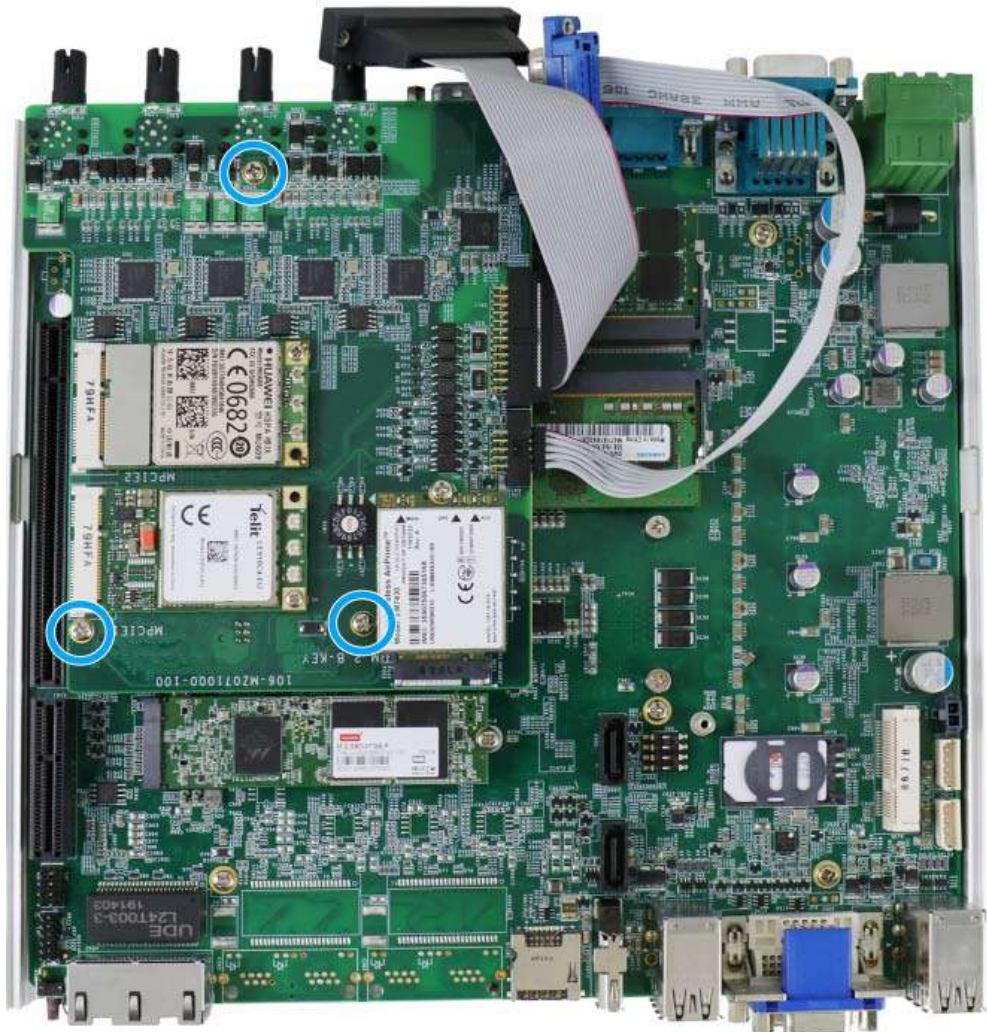

4. [Reinstall the system enclosure](#) and panel when done.
5. If you need to install other components, please refer to respective sections.

3.2.7 HDD/ SSD Installation (Nuvo-7100 VTC Series Systems)

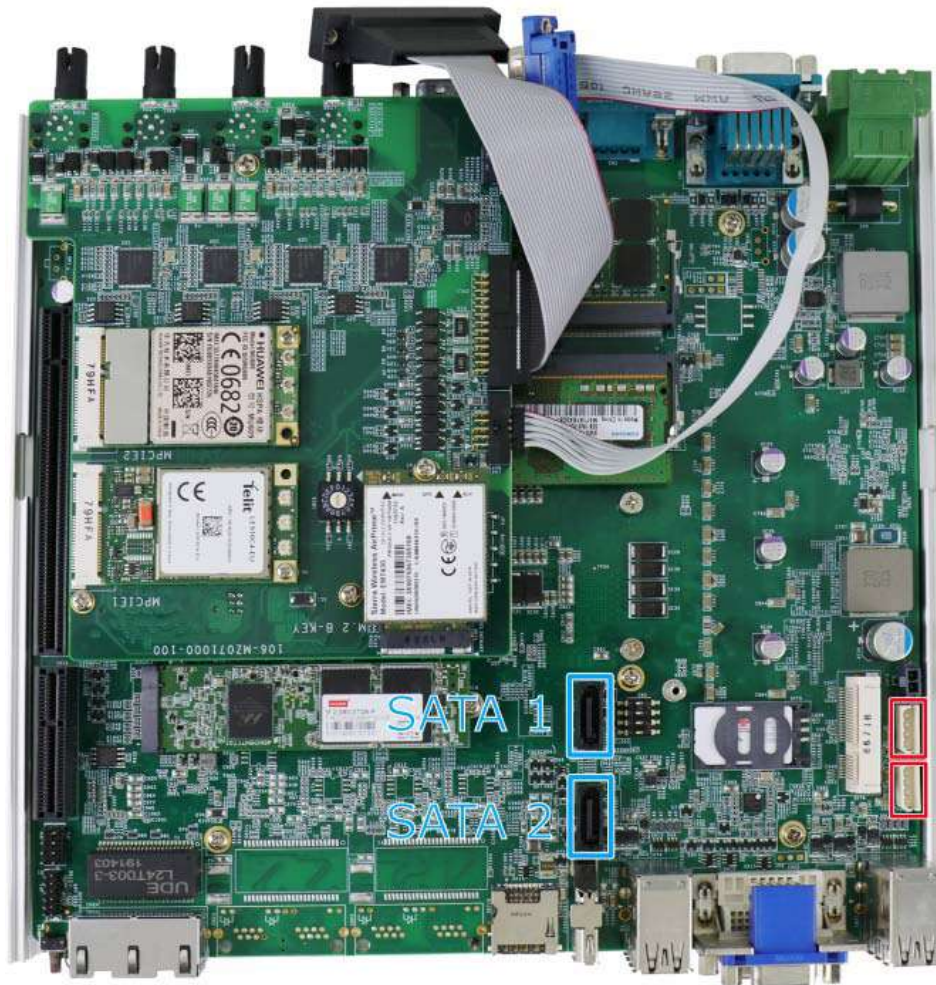

The system has two SATA ports (indicated in **blue**) and two four pin power connectors (indicated in **red**). The SATA and power cables should already be connected on the motherboard so users only need to install the HDD/ SSD. Please refer to the following instructions on how to install 2.5" SATA HDD/SSD.

1. Turn the system upside-down and remove the three screws indicated in the illustration below and lift the tray out of the system.



2. Take the HDD/ SSD thermal pad out of the accessory box and place it in the middle of the tray. Remove the protective film covering the HDD/ SSD thermal pad.



3. Secure the HDD/ SSD and match the SATA connector end to the side with two screw holes (indicated in **blue**), secure the HDD/ SSD with the supplied flathead screws (4 per drive).



- At the tray opening, you should be able to locate the 22-pin SATA cable, connect it to the installed HDD/ SSD.



- Gently put the tray back into the system with the connector side being inserted into the system first and secure the tray with three screws.



Reinsert the tray



Secure the tray

- If you need to install other components, please refer to respective sections.

3.2.8 HDD/ SSD Installation to Hot-swappable Tray

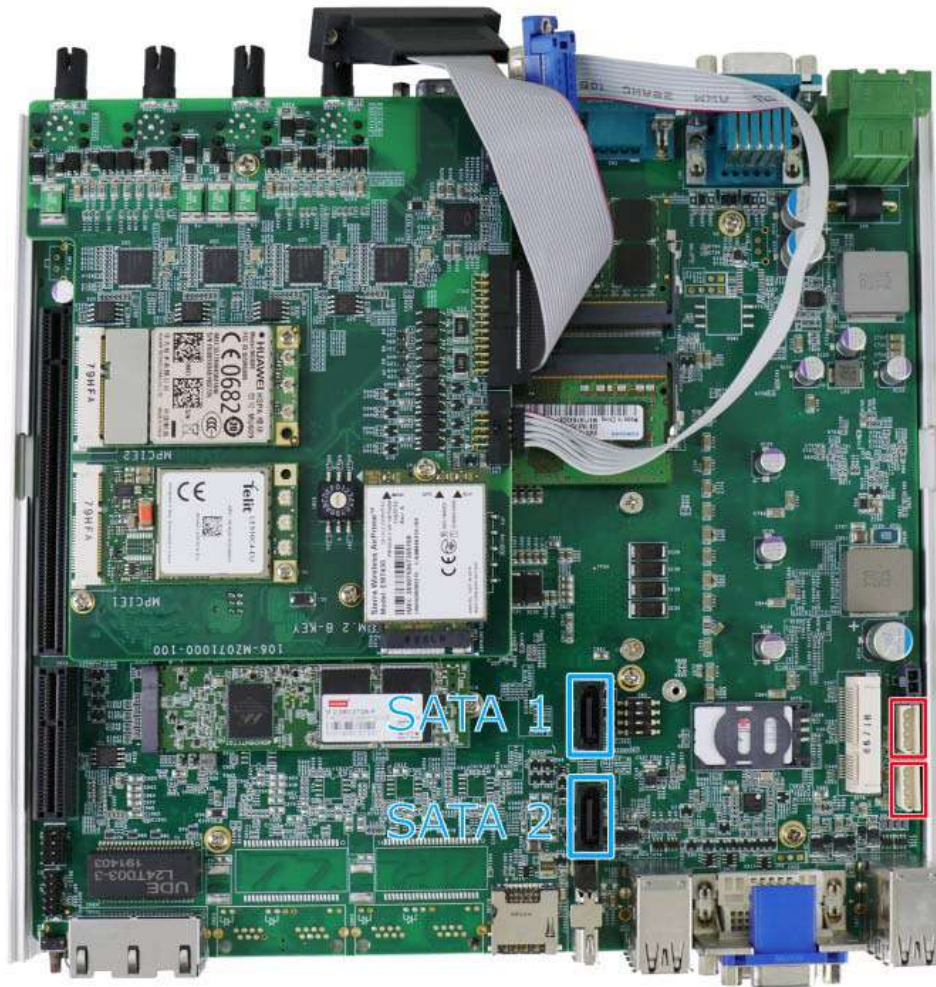

The system has two SATA ports (blue) and two four pin power connectors (red). The SATA and power cables should already be connected on the motherboard so users only need to install the 2.5" SATA HDDs/ SSDs to the front hot-swappable tray(s) For Nuvo-7100VTC systems, there is also an internal drive that can be coupled to configured into RAID 0 or 1 storage.

If you previously disconnected the SATA and power cables, please reconnect them before continuing this procedure.

1. The SATA and power cable should already be connected to the hot-swappable tray inside the enclosure.

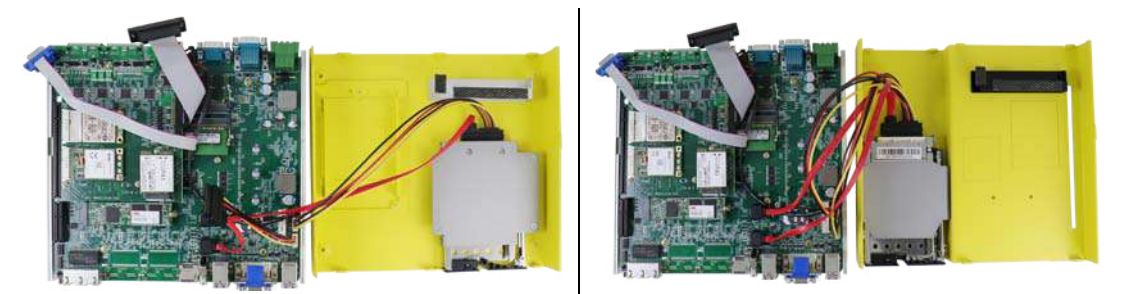

Nuvo-7100VTC series

Nuvo-7200/ 7250VTC series

2. Pull the lever on the 2.5" external hot-swappable slot to swing open the cover.



3. With the label side facing upward, insert the SATA connector side of the 2.5" HDD/ SSD into the slot first. You may feel resistance when the SATA connectors meet, push it in firmly until the 2.5" HDD/ SSD is fully inserted into the slot.



4. Push the lever into the 2.5" slot until it snaps into position. A key is provided (in accessory box) to lock the external slot.



Key in accessory box



2.5" HDD/ SSD slot lock

3.2.9 Ethernet/ PoE+ Port Panel Screw Fix

The system's RJ45 Ethernet ports have panel screw fix holes (indicated in blue circles) to secure the cable connection.

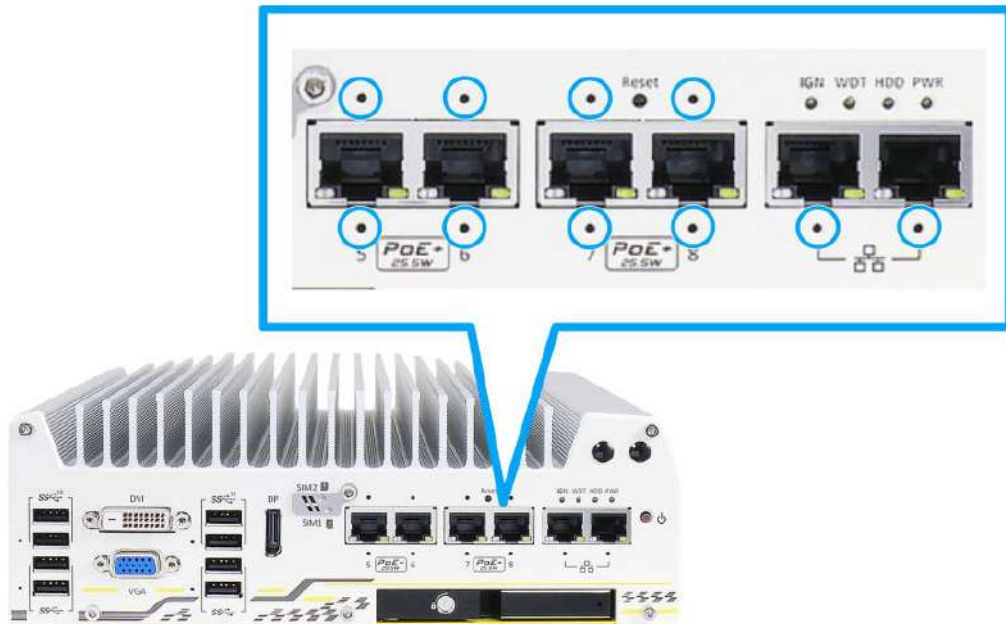

NOTE

Ports underneath the status LEDs have only the fix hole at the bottom.

1. To install and make use to the panel screw fix connection, you must acquire panel screw fix cables such as the cable shown below.



2. Simply insert the RJ45 connector into the RJ45 port and secure the top and bottom screws using your fingers or a screw driver.



3.2.10 PCIe Card Installation into Cassette Module (Nuvo-7200VTC)

 **WARNING**

To reduce the risk of damage, **DO NOT** remove PCIe card from the antistatic bag (or its original packaging) before it is ready to be installed into the Cassette module!



The Cassette module provides a separated compartment to accommodate an add-on card. It compartmentalizes the heat generated and effectively manages thermal conditions of both the system and add-on card(s). The modular design reduces the complexity of installing and replacing add-on card to offer system stability and reliability. To install a PCIe card into the Cassette module, please refer to the following procedure:

1. Turn the system upside-down and remove the four screws.



- Gently wiggle the Cassette module and separate it from the system enclosure.



- Remove the screws to open the Cassette cover.



- Remove the bezel cover (indicated in **blue circle**) and insert the card into the PCIe/PCI slot while making sure the bezel is properly inserted into the notch and the card is secured in place with screw.



Remove bezel cover



Make sure the card is inserted into the notch and secured with a screw

- Secure the screw indicated in the **blue circle**.



- Gently lower the Cassette module back onto the system enclosure and secure the module onto the system enclosure by securing the following screws.



3.3 PB-2500J Installation/ Replacement (Nuvo-7250VTC Series Only)



WARNING

To reduce the risk of damage, **DO NOT** remove replacement PB-2500J from the antistatic bag (or its original packaging) before it is ready to be installed into the Cassette module!

The Nuvo-7250VTC series systems come with PB2500J supercapacitor backup solution pre-installed in the Cassette module to safe guard your data during unforeseen power blackouts. If you need to maintain or swap the PB-2500J in the Cassette module, please refer to the following procedure.

1. Turn the system upside down and remove the four screws indicated.



2. Gently wiggle the Cassette module and separate it from the system enclosure.



3. Remove the screws to open the Cassette cover.



4. Turn the Cassette module to the connector side and remove the four screws.

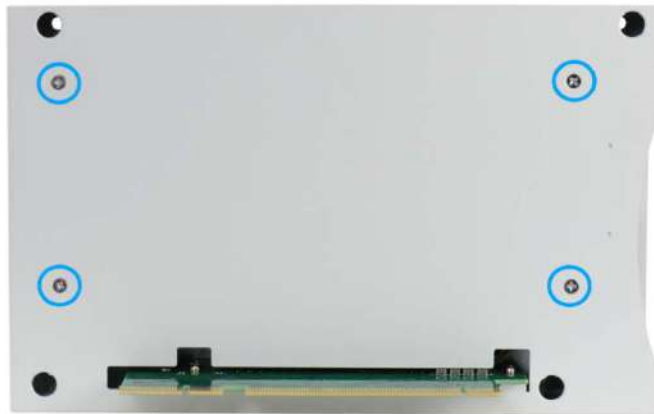

5. Disconnect the 2x 5-pin 2.0mm pitch cable from the connector, remove the screw securing the PB-2500J bracket, gently wiggle and lift PB-2500J out of the PCIe slot.

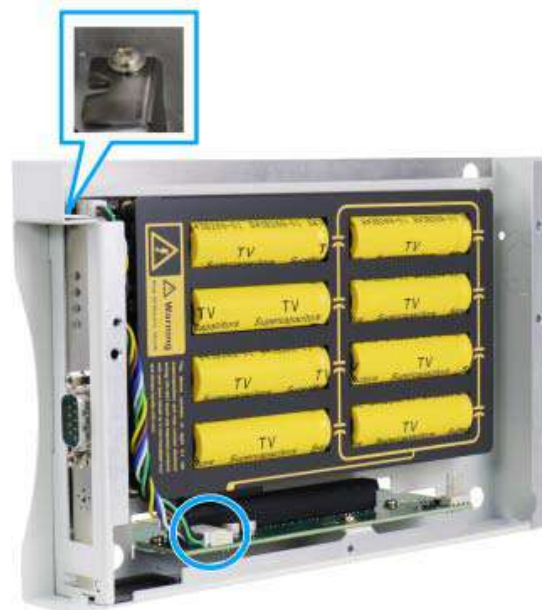

6. There is a back plate on PB-2500J that needs to be removed. The back plate is held in-place by five screws. Remove the screws indicated to separate the back plate and PB-2500J.

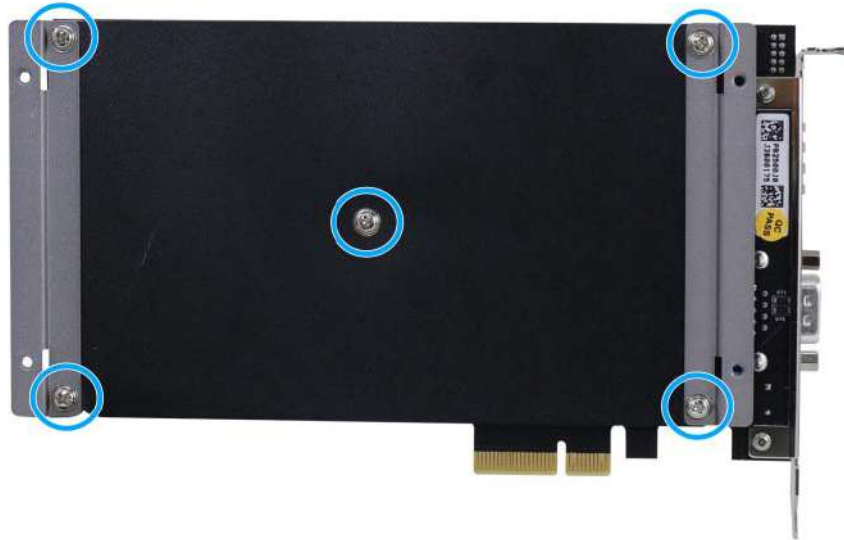

7. Take out the replacement PB-2500J of the static bag (or its original packaging) and secure in onto the back plate (screw locations shown in previous step).
8. Once the back plate has been secured onto PB-2500J, connect the 2x 5-pin 2.0mm pitch cable to the connector, lower the gold fingers of PB-2500J into the PCIe slot. Make sure the notch is properly inserted and secure the bracket with a screw.



9. Secure the back plate onto the Cassette module by securing the four screws.

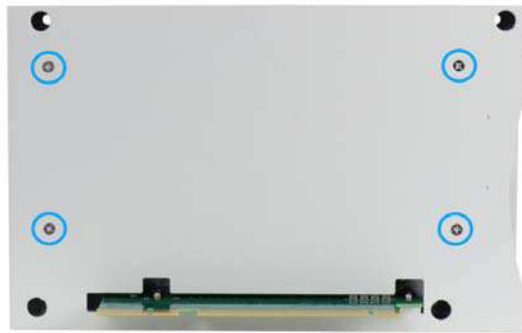

10. Secure the Cassette module cover by securing the three screws.



Lower the Cassette module onto the system and secure it with the four screws indicated.



Gently lower the Cassette module

Secure the Cassette module

11. Reconnect the COM-to-COM cable to connect the COM port of PB-2500J-PCIe to the COM port of your controller. Secure both COM ports. Please make sure the COM port is configured in RS-232 mode on the host controller.



3.4 Installing the System Enclosure

1. To reinstall the system enclosure, place the bottom panel on top of the motherboard while making sure both sides are inserted into the heatsink (indicated in **blue**).

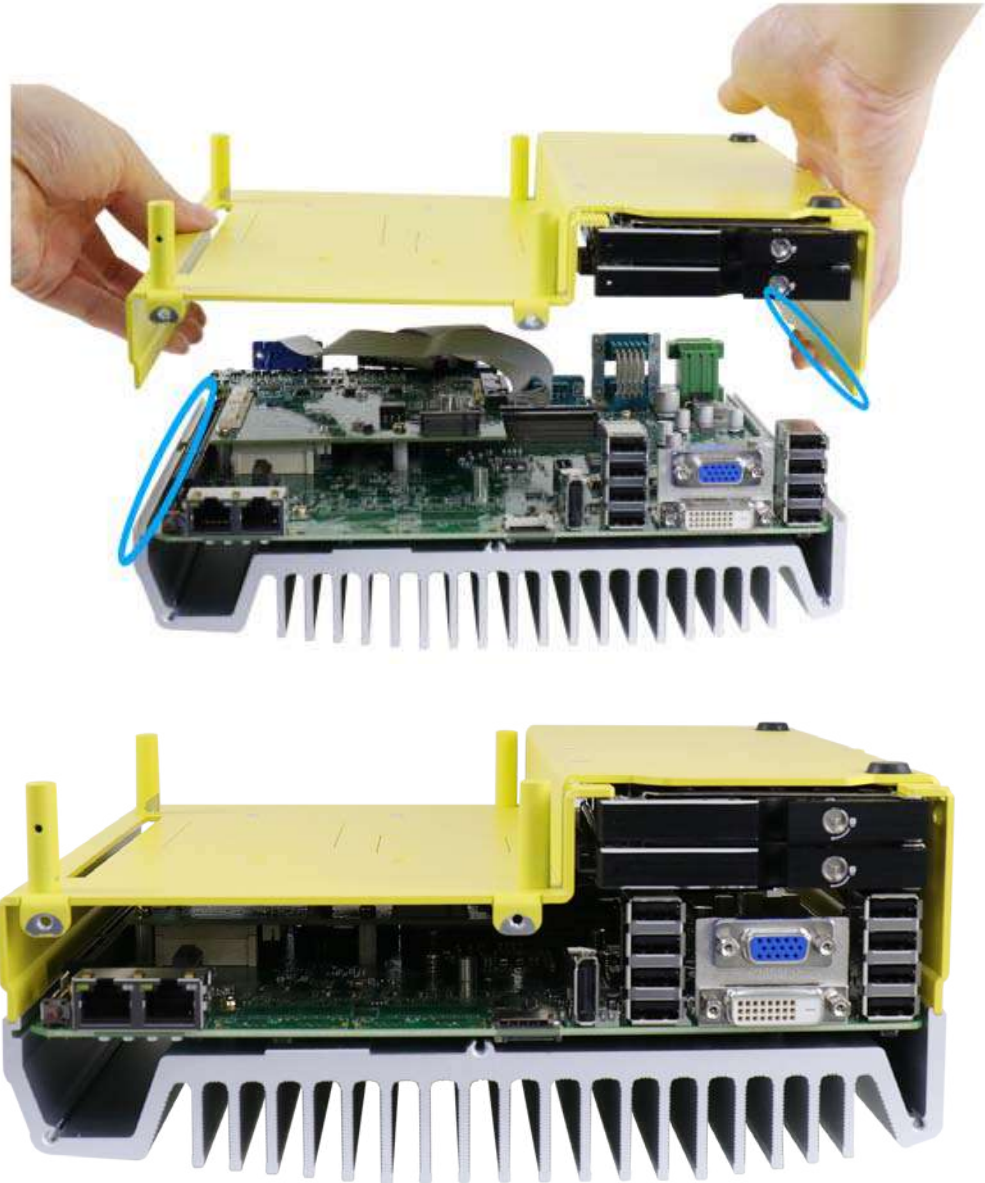

Nuvo-7200/ 7250VTC systems

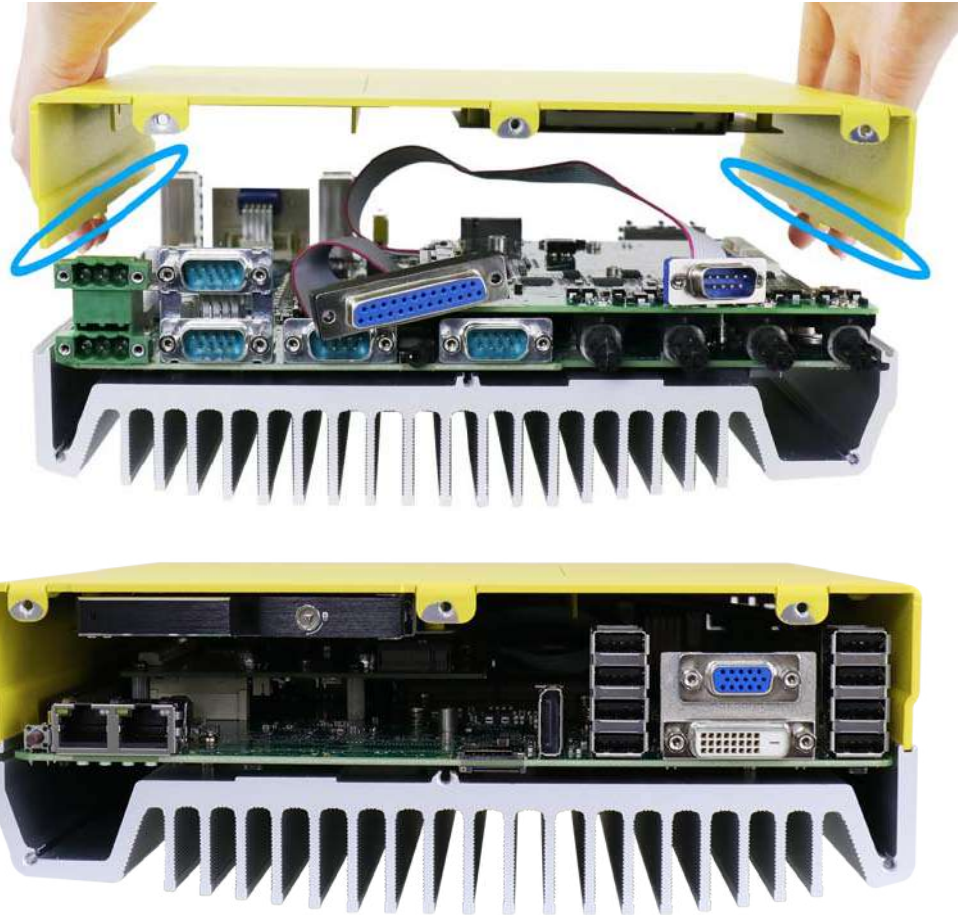

Nuvo-7100VTC systems



NOTE

Please connect the 22-pin SATA cable connected to the 2.5" hot swappable tray before installing the bottom panel.

2. Install the front panel and secure screws indicated in **blue**.



Nuvo-7200/ Nuvo-7250VTC series systems



Nuvo-7100VTC series systems

3. Install the rear panel and secure screws indicated in **blue**.



Nuvo-7200/ Nuvo-7250VTC series systems



Nuvo-7100VTC series systems

4. Install the Cassette module and secure screws indicated in **blue**.



NOTE

Not applicable to Nuvo-7100VTC systems.



3.5 Wall Mount Bracket/ DIN-rail Installation

Nuvo-7000VTC series ships with dedicated wall mount and DIN-rail (optional).

 **NOTE**

You will need to remove the four (4) rubber stands at the bottom of the enclosure if they have been attached.

DIN rail installation is NOT applicable to Nuvo-7200VTC/ Nuvo-7250VTC systems.

3.5.1 Nuvo-7100VTC Series Wall Mount Bracket Installation

To install the system as a wall mount device, please refer to the following instructions.

1. Take out the wall mount bracket and four (4) M4 screws out of the accessory box.
Fix the wall mount brackets to the system enclosure using M4 screws.

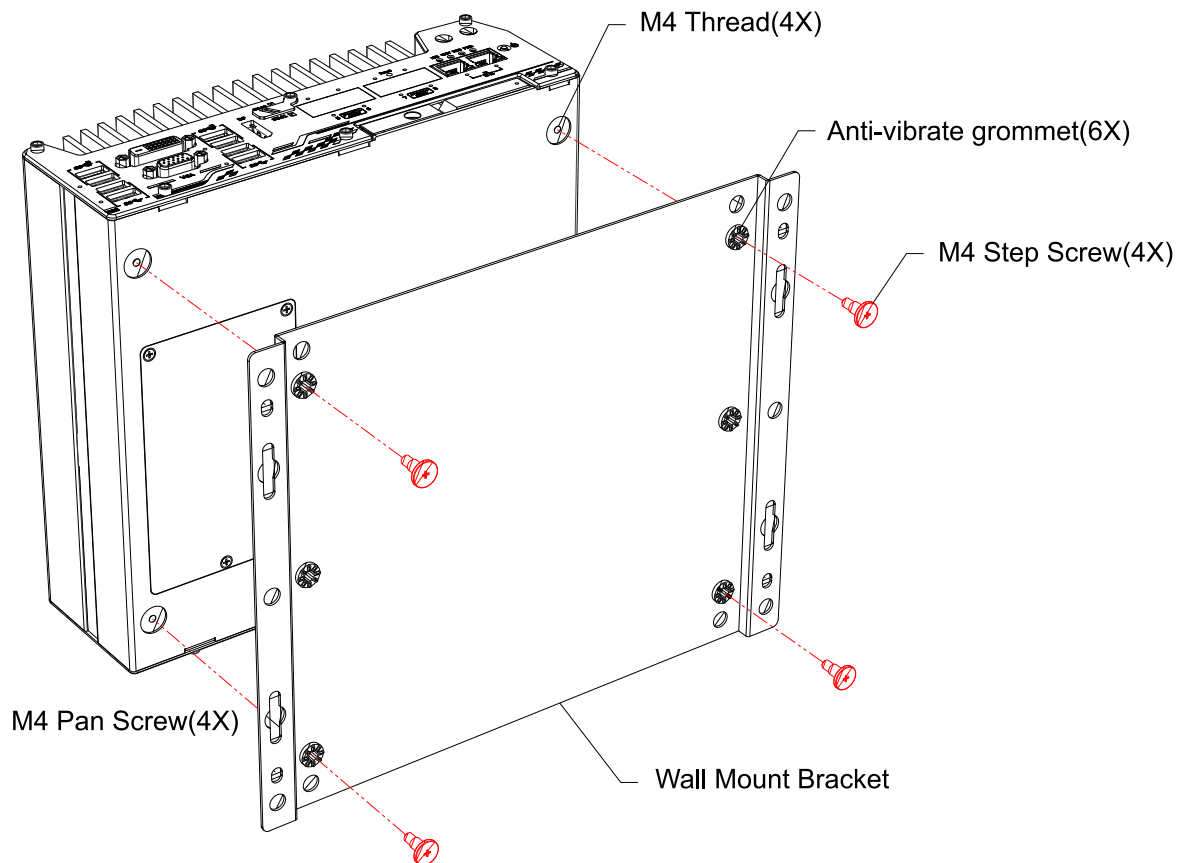

2. Place the system on a flat surface and secure it with M4 screws.
3. When wall mounting, place the heatsink fins perpendicular to the ground for better heat dissipation efficiency.

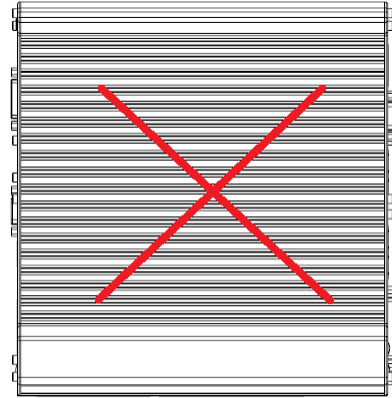
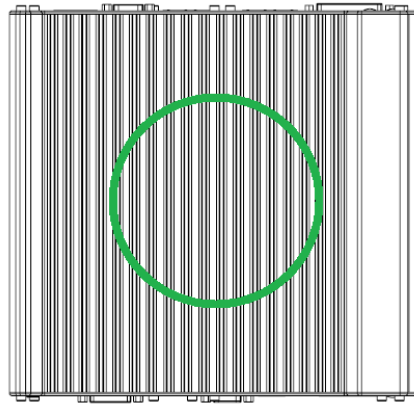

3.5.2 Nuvo-7200/ 7250VTC Series Wall Mount Bracket Installation

To install the system as a wall mount device, please refer to the following instructions.

1. Take out the two wall mount brackets and six (6) M4 screws out of the accessory box. Fix the wall mount brackets to the two sides of the system enclosure using M4 screws.

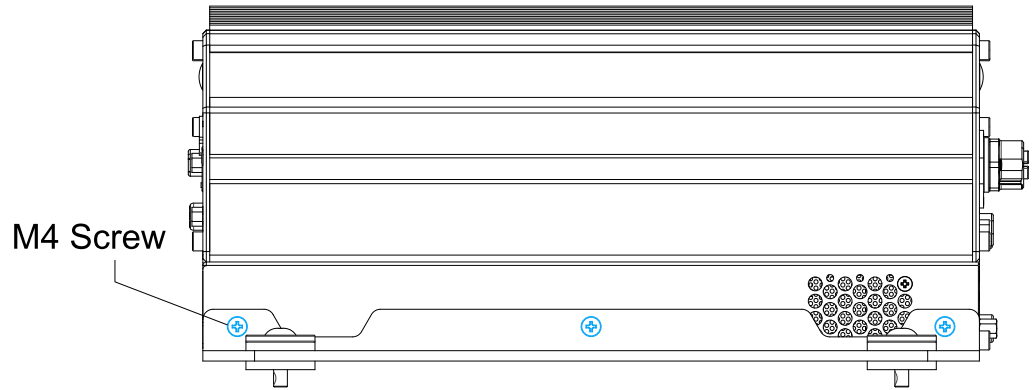

2. Place the system on a flat surface, insert the sleeves into the anti-vibration grommets and secure it with M4 screws.

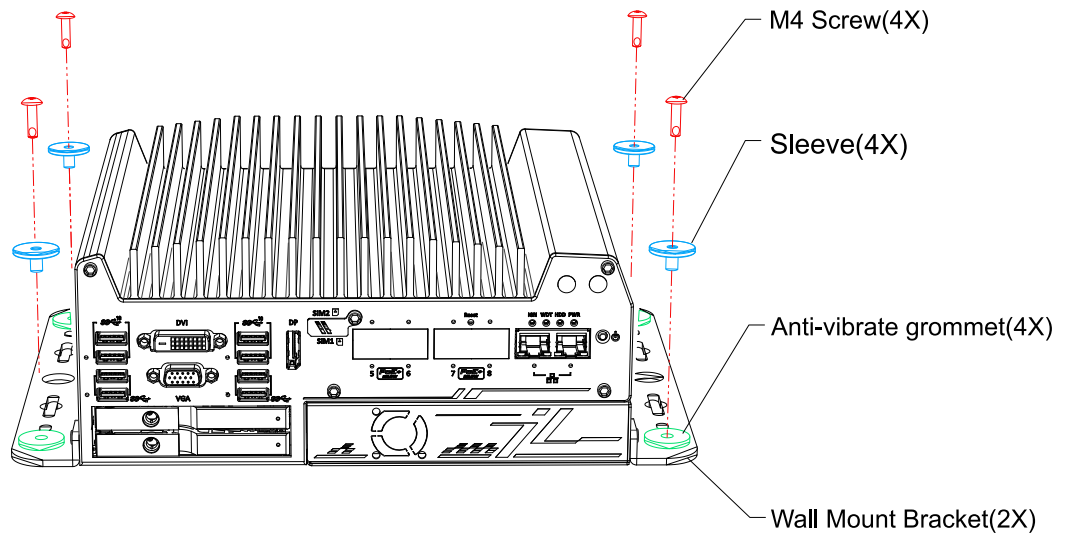

3. When wall mounting, place the heatsink fins perpendicular to the ground for better heat dissipation efficiency.

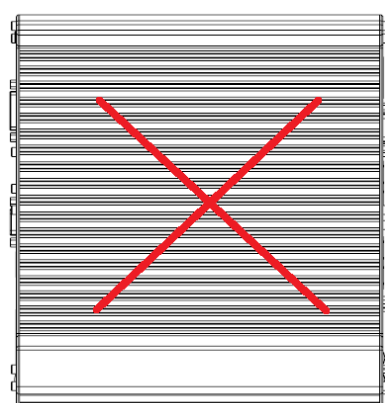
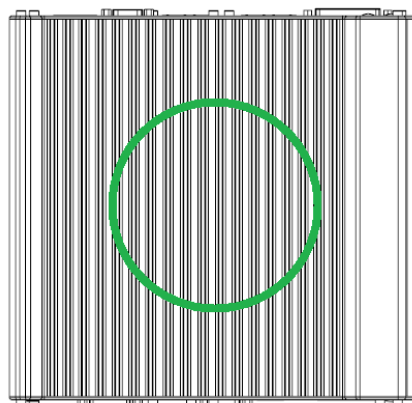

3.5.3 DIN-rail Installation (Optional)



NOTE

DIN rail installation is NOT applicable to Nuvo-7200VTC/ Nuvo-7250VTC systems.

The system also comes with an optional DIN-rail mounting kit. The kit includes a bracket and a DIN-rail mounting clip. By fixing the clip to the bracket using four M4 flat-head screws and fixing the bracket assembly to the system four M4 screws, complete the installation by clipping the system onto the DIN rail. This option may be useful if you want to deploy it inside an equipment cabinet where DIN rail is available.

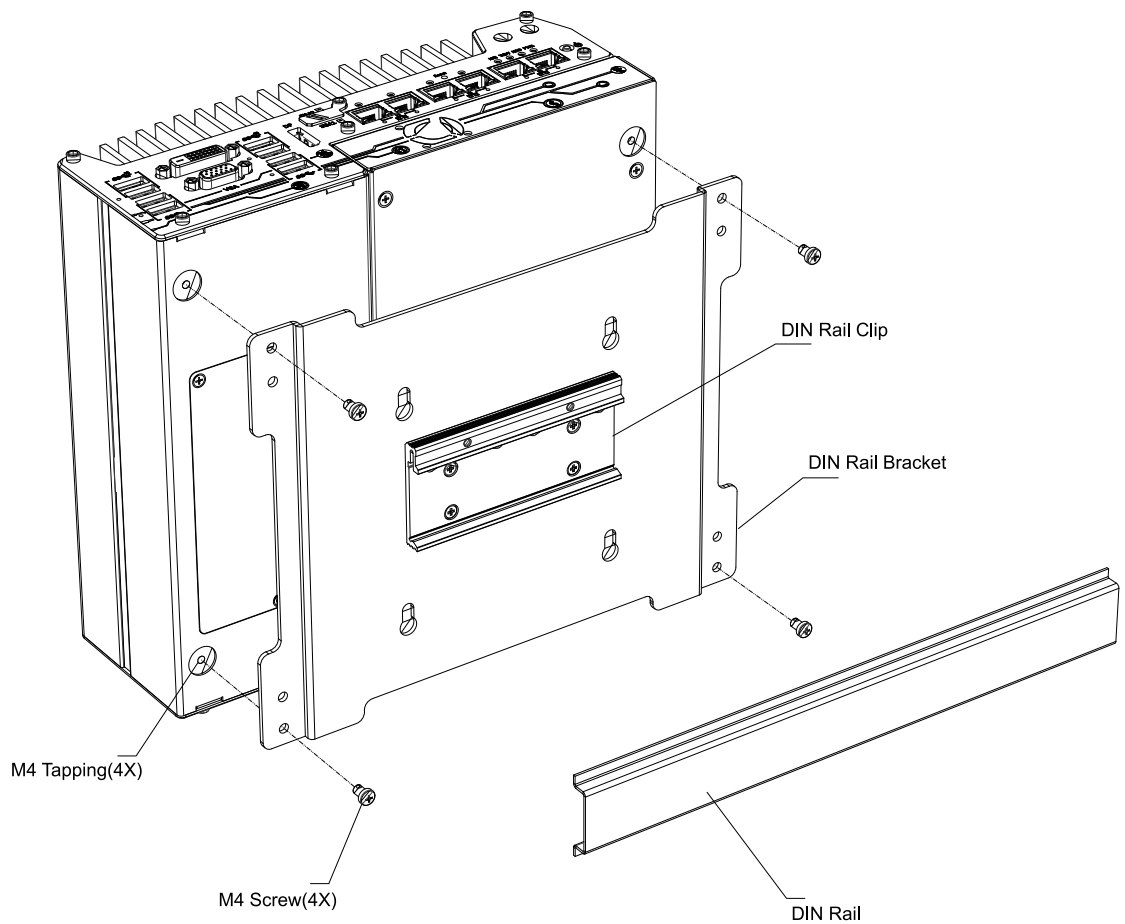

3.6 Powering On the System

There are three methods to power on the system

- Pressing the power button
- Using an external non-latched switch by connecting to the remote on/ off plug
- Sending a LAN packet via Ethernet (Wake-on-LAN)

Powering on using the [ignition power control](#) is described in a designated section.

3.6.1 Powering On Using the Power Button

This is the simplest way to turn on your system. The power button on the front panel is a non-latched switch and behaves as the ATX-mode on/off control. With DC power connected, pushing the power button will turn on the system and the PWR LED indicator will light up. Pushing the button when system is on will turn off the system. If your operating system supports ATX power mode (i.e. Microsoft Windows or Linux), pushing the power button while the system is in operation will result in a pre-defined system behavior, such as shutdown or hibernation.

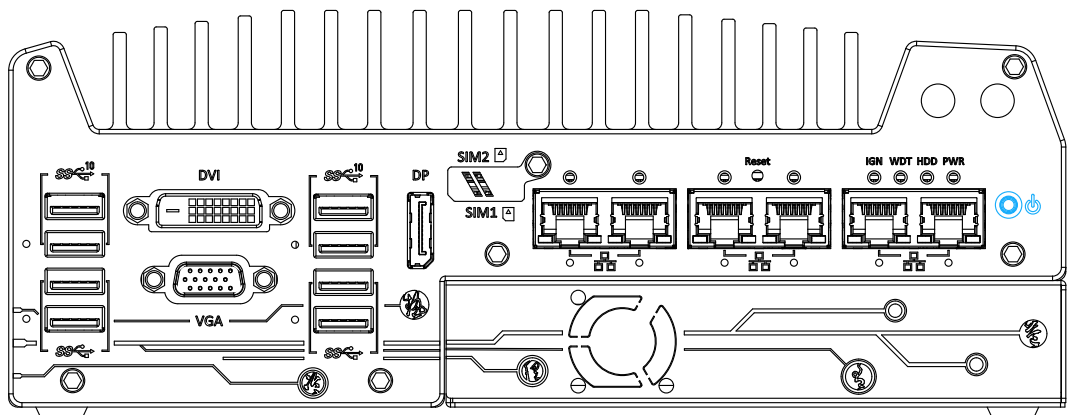

3.6.2 Powering On Using External Non-latched Switch

If your application demands the system to be placed inside a cabinet, you may use an external non-latched switch to power on/ off the system. The system provides a 3-pin “Remote On/ Off” plug for connecting a non-latched switch and acts as the ATX-mode power on/off control switch. The external non-latched switch acts exactly the same as the power button on the front panel. To setup and power on/ off the system using an external non-latched switch (ATX-mode), please follow the steps described below.

1. Acquire a non-latched switch with 3-pin plug.
2. Connect the non-latched switch to the Remote On/ Off plug.

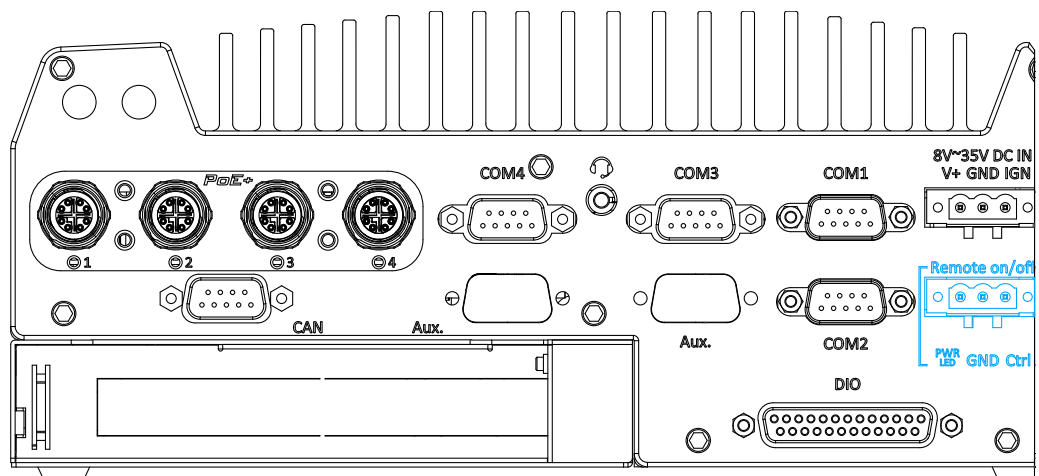

3. With DC power connected, pushing the power button will turn on the system and the PWR LED indicator will light up. Pushing the button when system is on will turn off the system. If your operating system supports ATX power mode (i.e. Microsoft Windows or Linux), pushing the power button while the system is in operation will result in a pre-defined system behavior, such as shutdown or hibernation.

3.6.3 Powering On Using Wake-on-LAN

Wake-on-LAN (WOL) is a mechanism to wake up a computer system from a S5 (system off with standby power) state via issuing a magic packet. The system's Wake-on-LAN compatible GbE port is shown below.

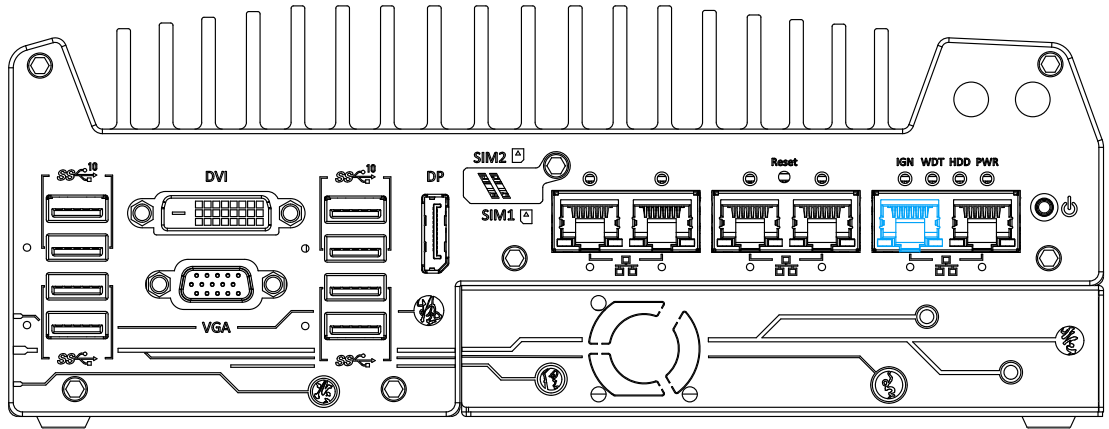

 **NOTE**

Please make sure the Intel® chipset and Ethernet driver has been properly installed prior to setting up WOL function.

To enable WOL function, please set up WOL settings in the BIOS and in the operating system by follow the steps described below.

1. When the system boots up, press F2 to enter BIOS setup utility.
2. Go to the **[Power]>[Wake On LAN]** and set it to **[Enabled]**.
3. Press F10 to **“Save changes and exit BIOS”** and allow the system boot into the operating system.

4. Once booted into the Windows system, press **“Windows key + E”**, right-click on **“Network>Properties>Change adapter settings”**. Locate and double-click on the adapter Intel® I219 Gigabit Network Connection, click on **Configure...**

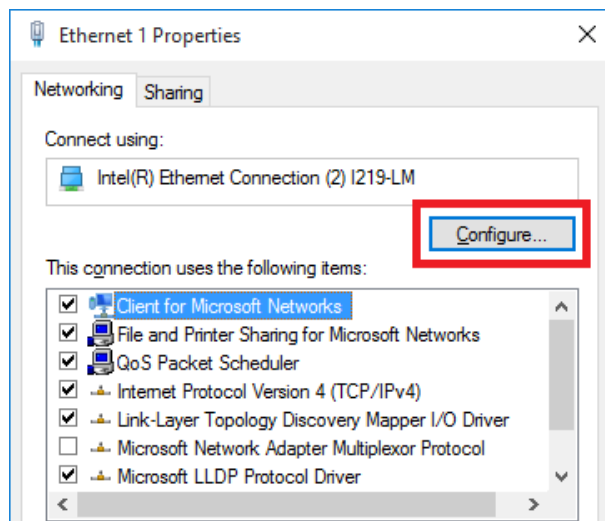

- Click on the **Power Management** tab and check the following options. Click on OK when done.

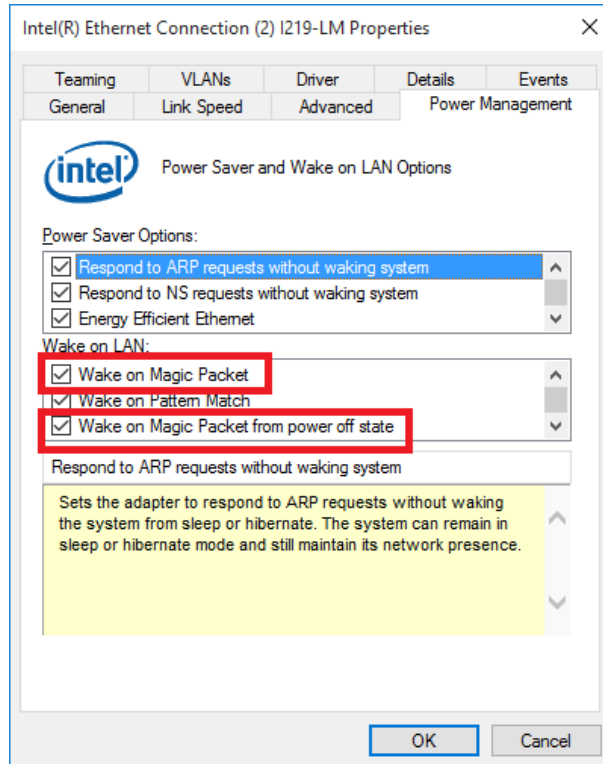

Magic Packet

The magic packet is a broadcast frame containing anywhere within its payload 6 bytes of all 255 (FF FFFFFFFF in hexadecimal), followed by sixteen repetitions of the target computer's 48-bit MAC address.

For example, NIC's 48-bit MAC Address is 78h D0h 04h 0Ah 0Bh 0Ch

DESTINATION SOURCE MISC

FF FFFFFFFF

78 D0 04 0A 0B 0C 78 D0 04 0A 0B 0C

78 D0 04 0A 0B 0C 78 D0 04 0A 0B 0C

78 D0 04 0A 0B 0C 78 D0 04 0A 0B 0C

78 D0 04 0A 0B 0C 78 D0 04 0A 0B 0C

78 D0 04 0A 0B 0C 78 D0 04 0A 0B 0C

78 D0 04 0A 0B 0C 78 D0 04 0A 0B 0C

78 D0 04 0A 0B 0C 78 D0 04 0A 0B 0C

78 D0 04 0A 0B 0C 78 D0 04 0A 0B 0C

MISC CRC

There are some free tools available on Internet that can be used to send a magic packet. Please refer to the following link to understand more about [Magic Packet](#).

3.7 Ignition Power Control

The ignition power control module for in-vehicle applications is a MCU-based implementation that monitors the ignition signal and reacts to turn on/off the system according to predefined on/off delay. Its built-in algorithm supports other features such as ultra-low power standby, battery-low protection, system hard-off, etc. In this section, we'll illustrate the principle of ignition power control and operation modes.

3.7.1 Principles of Ignition Power Control

The basic concept of ignition power control module is to control the timing correlation between ignition signal and system power status. A typical timing correlation is described in following diagram.

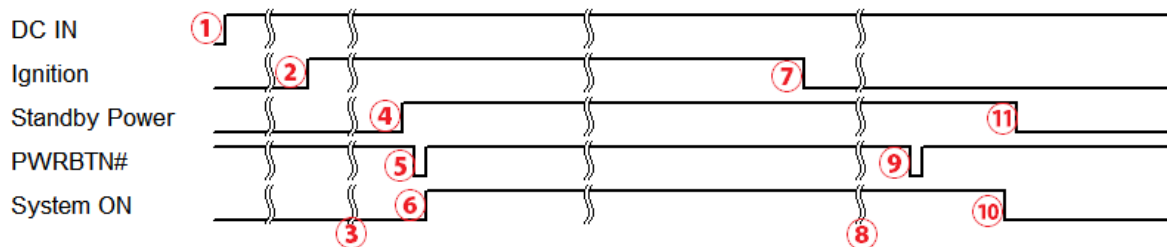

1. When DC power is supplied to the system, MCU starts to periodically detect ignition signal. Note that only MCU is working at this moment and the overall power consumption is less than 2 mW.
2. Ignition signal is active (both 12VDC and 24VDC ignition signals are accepted).
3. MCU starts to count a pre-defined power-on delay.
4. Once power-on delay expired, MCU turns on necessary standby power for the system (3.3VSB & 5VSB).
5. A PWRBTN# pulse is then issued to turn on the system (equivalent to one pressing the power button on the front panel).
6. The system is booting and becomes operational.
7. After a period of time, the ignition signal becomes inactive.
8. MCU starts to count a pre-defined power-off delay.
9. Once power-off delay expired, another PWRBTN# pulse is issued to perform a soft-off for the system (ex. a normal shutdown process for Windows system).
10. The system is completely shut down.
11. As MCU detects system is off, it turns off the standby power for the system, and operates in low power mode again (< 2mW power consumption).

3.7.2 Additional Features of Ignition Power Control

In addition to the typical timing correlation, the ignition power control module offers additional features to provide additional reliability for in-vehicle applications.

- **Low battery detection**

The ignition power control module continuously monitors the voltage of DC input when the system is operational. If input voltage is less than 9V (for 12VDC input) or less than 18V (for 24VDC input) over a 60-second duration, it will shut down the system automatically.

- **Guarded power-on/ power-off delay duration**

If ignition signal goes inactive during the power-on delay duration, the ignition power control module will cancel the power-on delay process and go back to idle status. Likewise if ignition signal goes active during the power-off delay duration, the ignition power control module will cancel the power-off delay process and keep the system running.

- **System hard-off**

In some cases, system may fail to shutdown via a soft-off operation due to system/ application halts. The ignition power control module offers a mechanism called “hard-off” to handle this unexpected condition. By detecting the system status, it can determine whether the system is shutting down normally. If not, the ignition power control module will force cut-off the system power 10 minutes after the power-off delay duration.

- **Smart off-delay**

The ignition power control module offers two modes (mode 6 & mode 7) which have very long power-off delay duration for applications require additional off-line time to process after the vehicle has stopped. In these two modes, the ignition power control module will automatically detect the system status during the power-off delay duration. If the system has shutdown (by the application software) prior to power-off delay expiring, it will cut off the system power immediately to prevent further battery consumption.

3.7.3 Wiring Ignition Signal

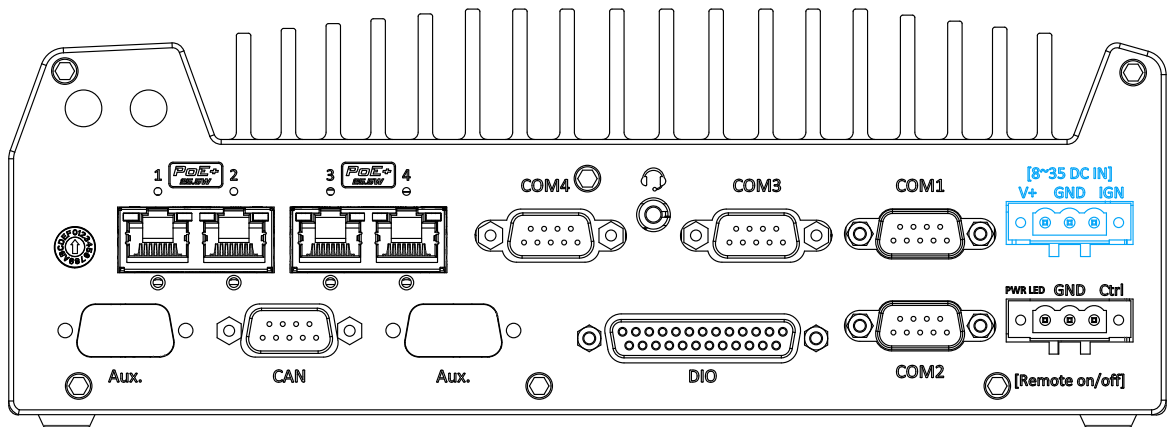

To have ignition power control for in-vehicle usage, you need to supply IGN signal to the system. The IGN input is located on the 3-pin pluggable terminal block (shared with DC power input). For in-vehicle ignition control wiring, please do the following:

1. Connect car Battery+ line (12V for sedan, 24V for bus/truck) to V+.
2. Connect car Batter-/ GND line to GND.
3. Connect ACC line to IGN.

 **WARNING**

Please make sure your DC power source and IGN signal share the same ground.

IGN input accepts 8~35VDC. Supply a voltage higher than 35VDC may damage the system.

3.7.4 Configure your Windows system

When applying ignition power control to your system, please make sure you've configured your Windows system to initiate a shutdown process when pressing the power button. By default, Windows 10 goes to sleep (S3) mode when power button is pressed. As sleep (S3) is not a complete shutdown behavior, the ignition control function does not recognize the finish of a normal shut down process and thus users will encounter a system hard-off (power cut-off after 10 minutes). Please configure "When I press the power button" to "Shut down" in your Windows system settings.

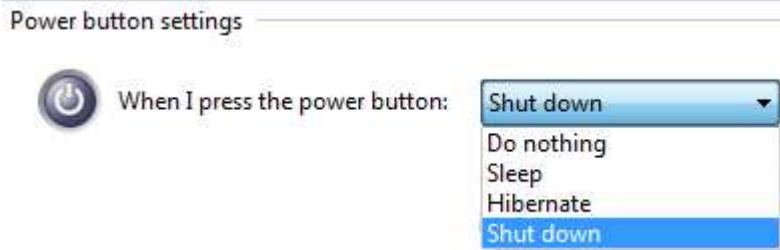

3.7.5 Operation Modes of Ignition Power Control

You can use the rotary switch to configure the operation mode. The system offers 16 (0~15) operation modes with different power-on/power-off delay configurations. The rotary switch can be located on the rear panel or the internal MeziO™ board, and to access it, please refer to the section “[Disassembling the System Enclosure](#)”.

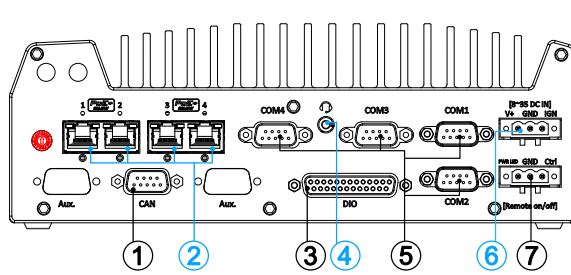

Nuvo-7104VTC/ 7108VTC

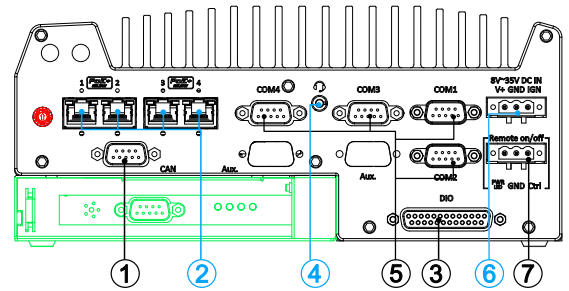

Nuvo-7204/ 7254VTC/ 7208VTC/ 7258VTC

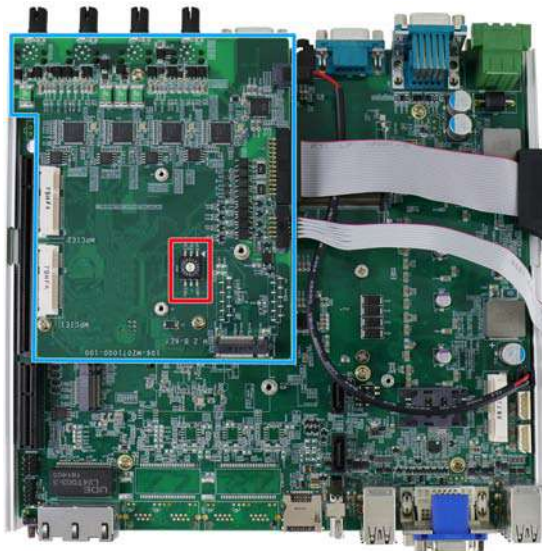

Nuvo-7100VTC/ Nuvo-7200/ Nuvo-7250VTC

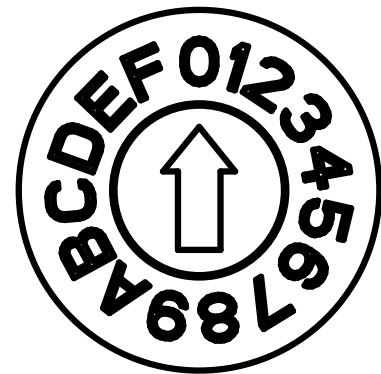

Ignition rotary switch

Ignition rotary switch on MeziO™ board

[The ignition control module is also BIOS-configurable.](#) When rotary switch is set to mode 15 (0xF), the ignition power control is set to executed according to parameters configured in BIOS setup menu, which allows richer combination of power-on/ power-off delay and more detailed control parameters.

- **Mode 0**

Mode 0 is the ATX mode without power-on and power-off delay. User can only use the power button on the front panel to turn on or turn off the system.

Mode	Power-on Delay	Power-off Delay	Hard-off Timeout
0	N/A	N/A	N/A

- **Mode 1**

Mode 1 is AT mode without power-on and power-off delay. The system automatically turns on when DC power is applied. A retry mechanism is designed to repeat the power-on cycle if the system fails to boot up.

Mode	Power-on Delay	Power-off Delay	Hard-off Timeout
1	N/A	N/A	N/A

- **Mode 2**

Mode 2 is designed to have a very minor power on/ off delay of 160ms for applications that requires the system to start up almost at the same as the rest of the equipment it is working in collaboration with.

Mode	Power-on Delay	Power-off Delay	Hard-off Timeout
2	160ms	160ms	10 minutes

- **Mode 3 ~ Mode 12**

Mode 3 ~ Mode 12 have various power-on delay and power-off delay. Each mode supports a hard-off timeout of 10 minutes.

Mode	Power-on Delay	Power-off Delay	Hard-off Timeout
3	10 seconds	10 seconds	10 minutes
4	10 seconds	1 minute	10 minutes
5	10 seconds	5 minutes	10 minutes
6	30 seconds	1 minute	10 minutes
7	30 seconds	5 minutes	10 minutes
8	30 seconds	10 minutes	10 minutes
9	3 minutes	1 minute	10 minutes
10 (A)	3 minutes	10 minutes	10 minutes
11 (B)	3 minutes	30 minutes	10 minutes
12 (C)	10 minutes	30 minutes	10 minutes

- **Mode 13 (D) / Mode 14 (E)**

Mode 13 and Mode 14 are ignition power control modes with very long power-off delay. Both modes support the feature of “smart off-delay”, which automatically detect system status during power-off delay duration and cut off system power if system is off in prior to power-off delay expired.

Mode	Power-on Delay	Power-off Delay	Hard-off Timeout
13 (D)	30 seconds	2 hours	10 minutes
14 (E)	3 minutes	2 hours	10 minutes

- **Mode 15 (F)**

Mode 15 allows the user to configure the ignition control in the BIOS. Please refer to the following section for details.

3.7.6 BIOS Ignition Power Control [Mode 15 (F)]

The Mode 15 for ignition control allows ignition control settings to be configured in the BIOS.

To set the ignition power control in the BIOS:

1. Press **F2** when the system boots up to enter the BIOS setup utility.
2. Go to **[Power]** → **[Ignition Power Control]** and press **ENTER**.

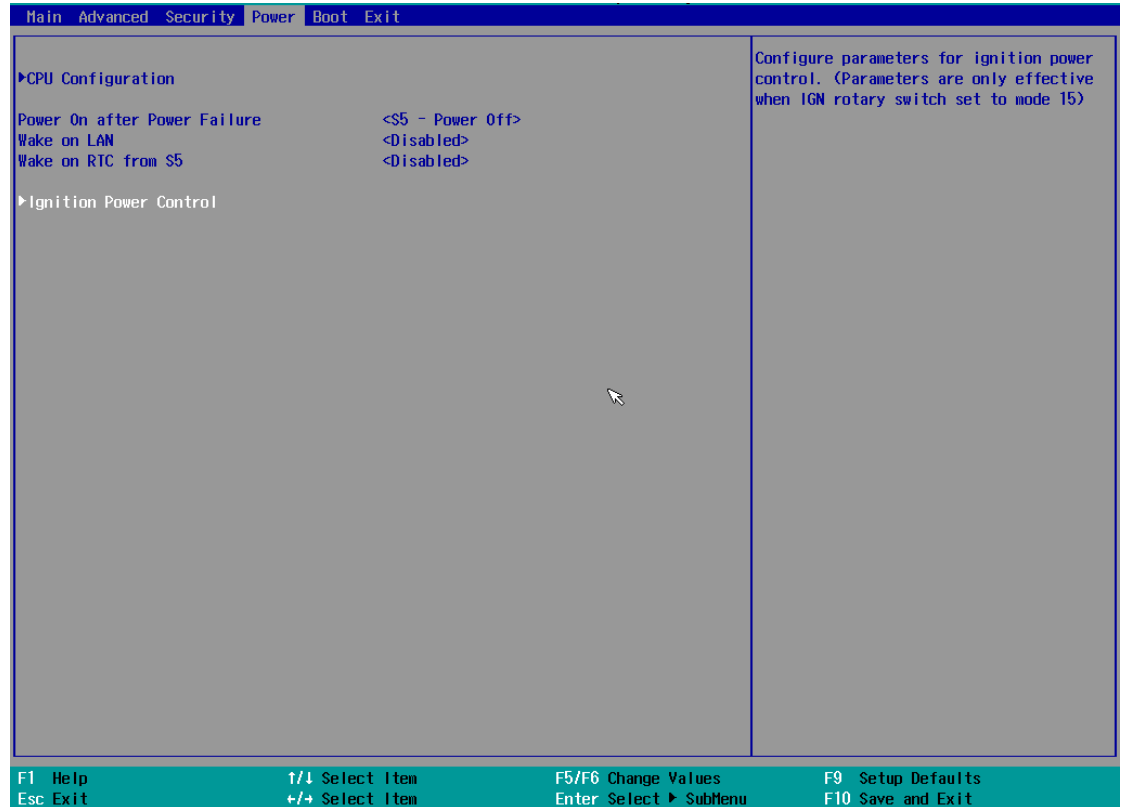

- Set **IGN Operation Mode** to “IGN” and press ENTER.

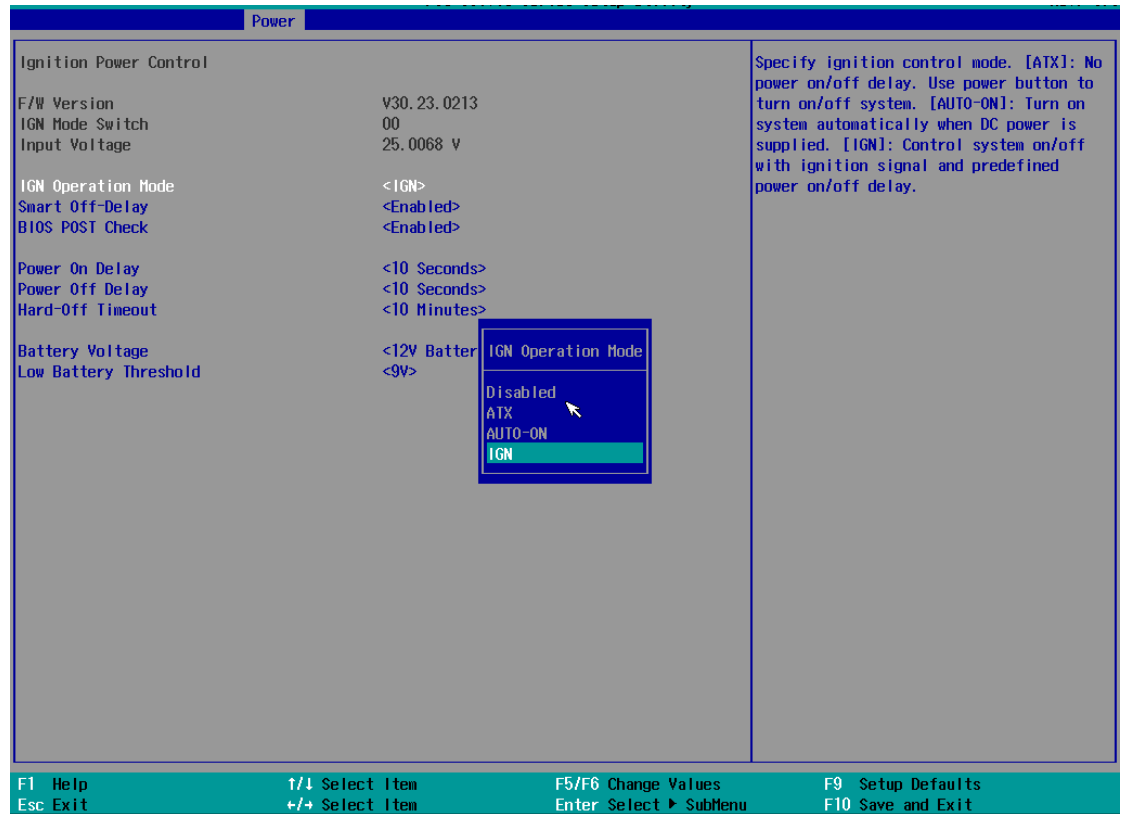

- If you wish to set the power on delay time from when you start-up the vehicle, highlight and select “Power On Delay”, select the timing according to your needs and press Enter.



- If you wish to set the power off delay time from when you turn off the vehicle, highlight and select “Power Off Delay”, select the timing according to your needs and press Enter.

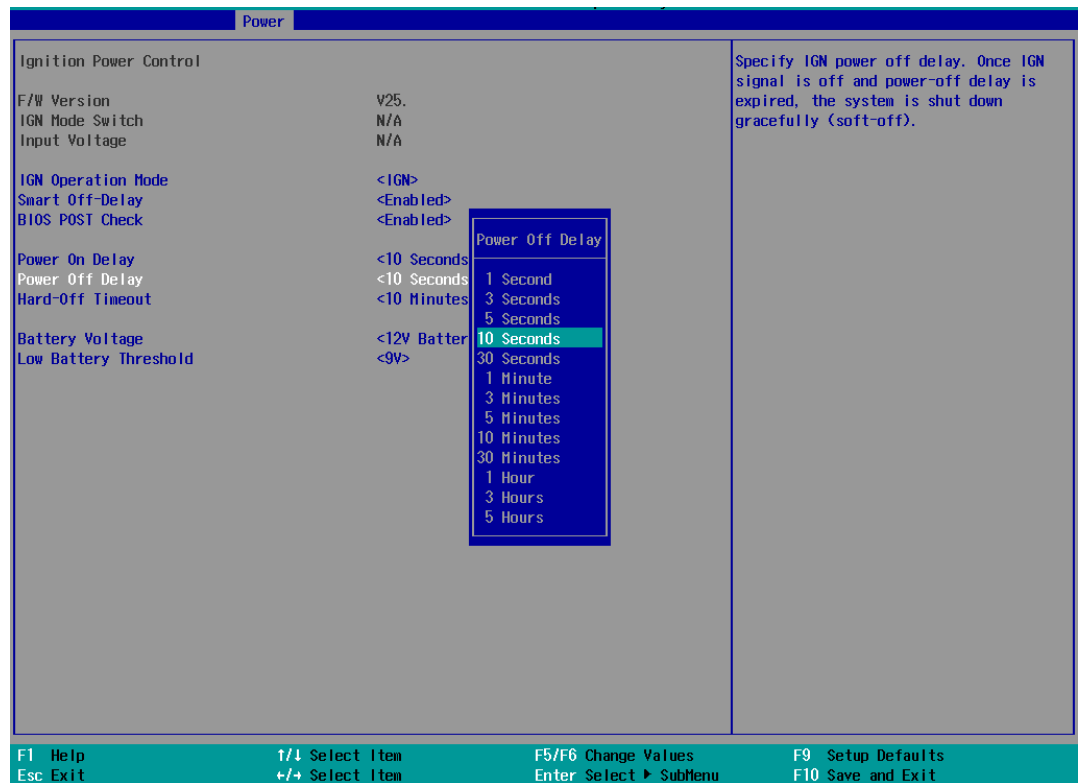

- If you wish to set the a hard power off timing, select “Hard-Off Timeout”, select the timing according to your needs and press Enter.

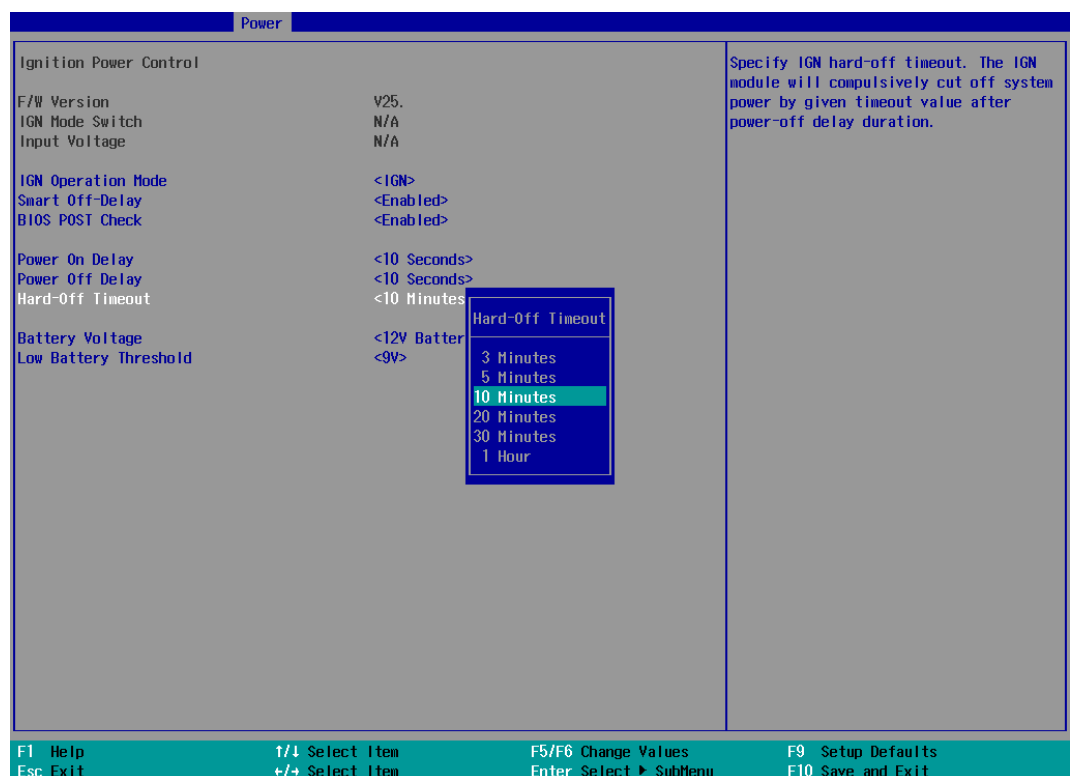

- For Battery voltage setting, you may choose between 12V (for normal passenger vehicles) or 24V (for trucks). Highlight an option and press Enter.

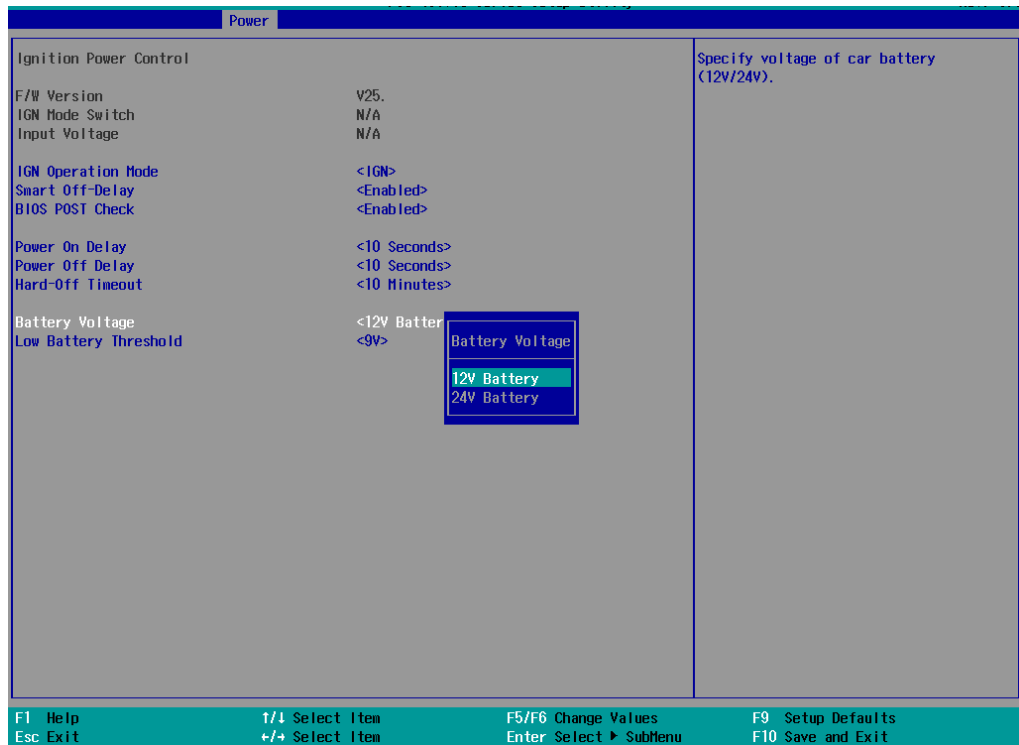

- To set the low battery threshold, highlight "Low Battery Threshold", select a setting, and press Enter.

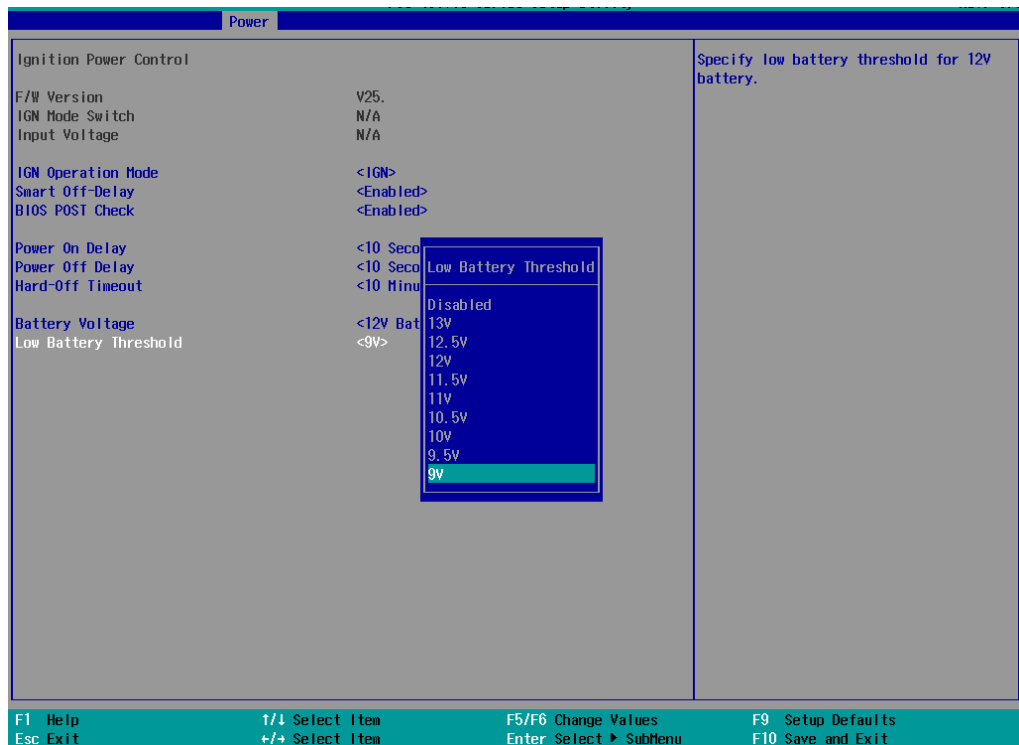



When you are done configuring the BIOS ignition control settings, press F10 to save changes and exit the BIOS.

4 System Configuration

4.1 BIOS Settings

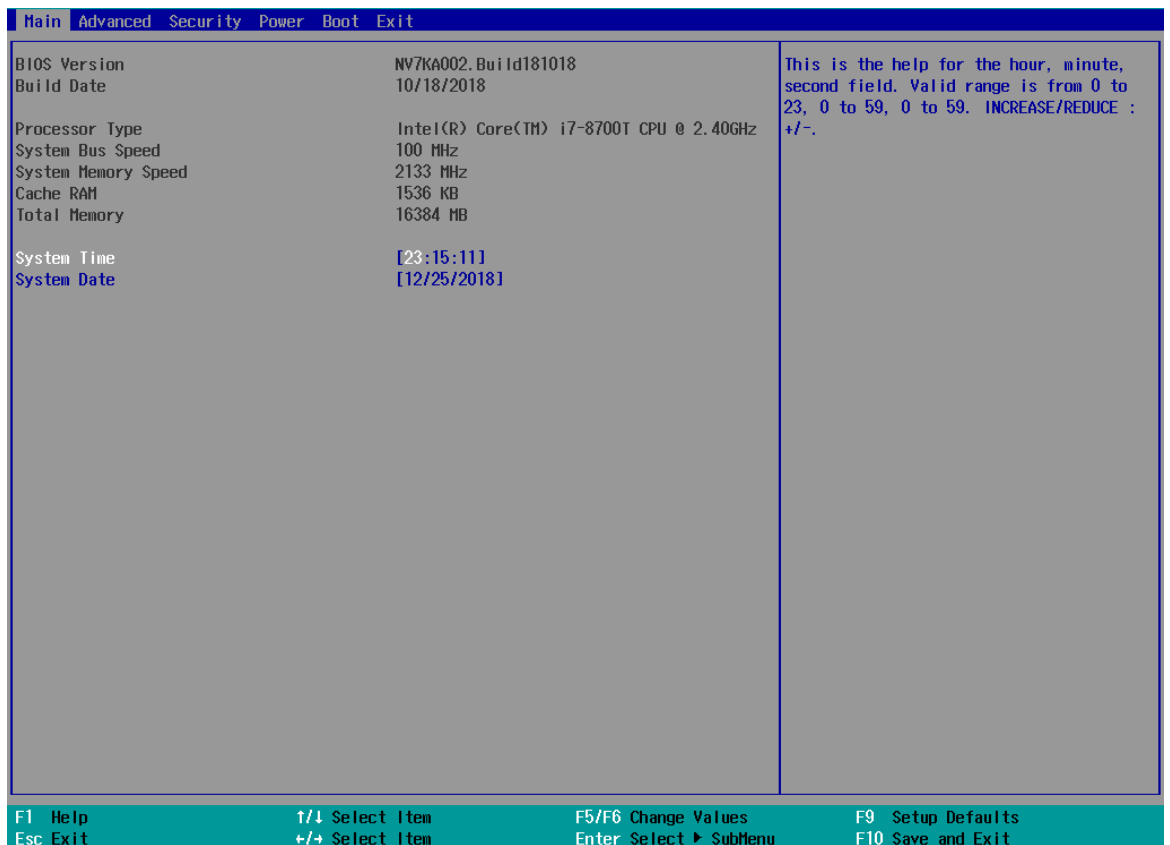
The system is shipped with factory-default BIOS settings meticulously programmed for optimum performance and compatibility. In this section, we'll illustrate some of BIOS settings you may need to modify. Please always make sure you understand the effect of change before you proceed with any modification. If you are unsure of the function you are changing, it is recommended to change one setting at a time to see its effect(s).



 **NOTE**

Not all BIOS settings will be discussed in this section. If a particular setting/ function you are after requires specific BIOS settings but is not discussed in this section, please contact Neousys Technical Support staff.

4.1.1 COM Port Configuration

The system's [COM1/ COM2](#) ports support RS-232 (full-duplex), RS-422 (full-duplex) and RS-485 (half-duplex) mode. You can set the COM1 operating mode via BIOS settings. Another option in BIOS called “*Slew Rate*” defines how sharp the rising/falling edge is for the output signal of COM1. For long-distance RS-422/485 transmission, you may set the “*Slew Rate*” option as “High” to improve signal quality. For RS-422/485 communication, the “*RS-422/485 Termination*” option determines whether to enable/disable internal termination of RS-422/485 transceiver according to your wiring configuration (e.g. with or without external termination).

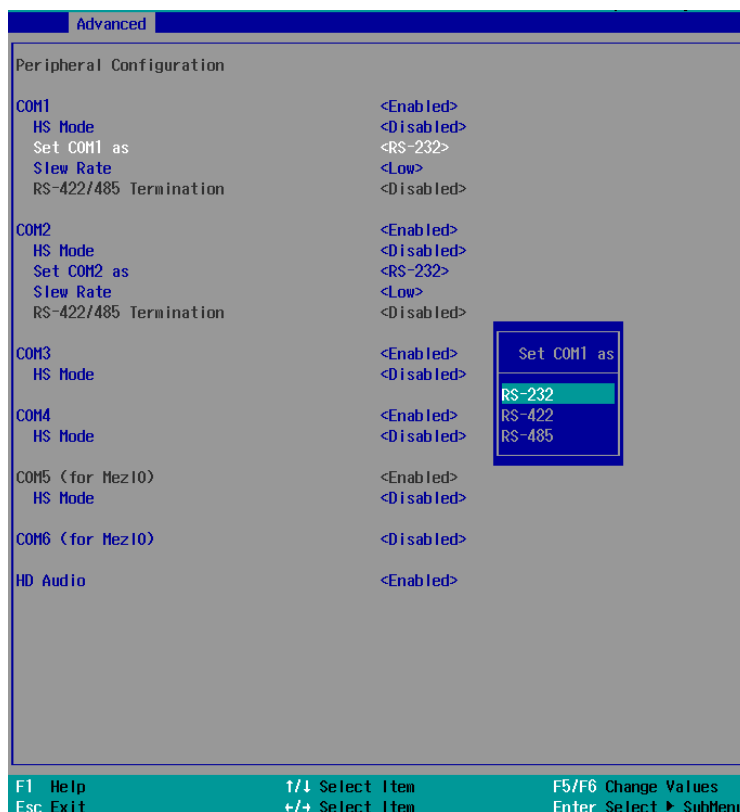

To set COM port operating mode:

1. Press **F2** when the system boots up to enter the BIOS setup utility.
2. Go to **[Advanced] > [Peripheral Configuration]**.
3. Set the **[Set COM1 Mode as]** option to the desired mode.
4. Once set, press **F10** to save setting and exit.

4.1.2 COM Port High Speed Mode

The high speed mode of each COM port effectively allows for the port's baud rate generator to operate at 8x the speed with an effective baud rate of 921,600 bps (115,200 x 8). Please refer to the following instructions on how to enable the high speed mode for your COM port (COM1 used as an example).



To set COM port high speed mode:

1. Press **F2** when the system boots up to enter the BIOS setup utility.
2. Go to [**Advanced**] > [**Peripheral Configuration**].
3. Enable or set the [**Set COM1 Mode as**] option to the desired mode.
4. Highlight [**HS Mode**] and press ENTER to bring up options, highlight [**Enable**] and press ENTER.
5. Once set, press **F10** to save setting and exit.

4.1.3 Delay for PEG Initialization

This setting offers delay in milliseconds for PEG port initialization and PCI enumeration. By increasing the delay value, it may eliminate compatibility issue(s) with some PCIe add-on cards.

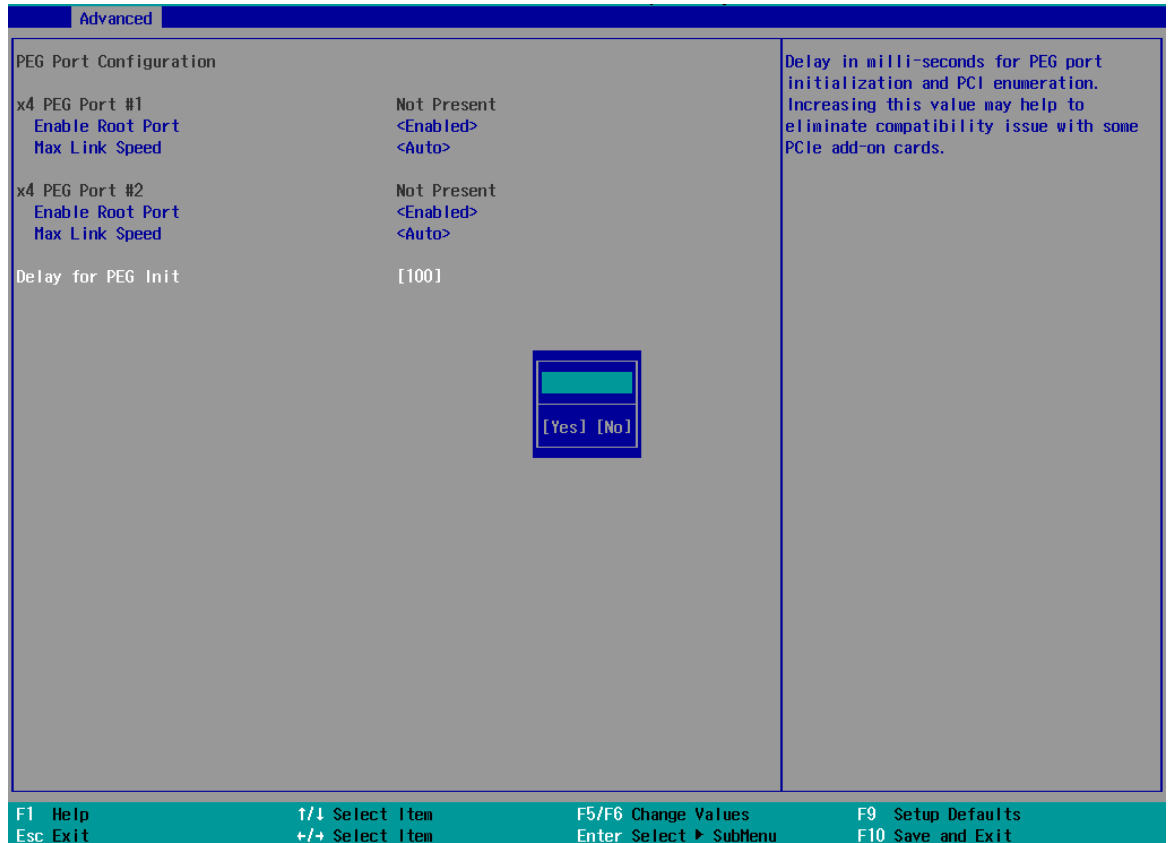

To set PEG delay in milliseconds:

1. When system boots up, press F2 to enter BIOS setup utility.
2. Go to **[Advanced] > [System Agent (SA) Configuration] > [PEG Port Configuration] > [Delay for PEG Init]** and press ENTER.
3. A small window appears and you may enter a maximum delay value of up to 30,000ms.
4. When done, press F10 to "Exit Saving Changes"

4.1.4 SATA Configuration

The SATA controller of your system supports two (2) operating modes: **AHCI** and **Intel RST Premium With Intel Optane System Acceleration mode**. The **AHCI** mode, which exposes SATA's advanced capabilities such as hot swapping and native command queuing, is supported in several later version of operating systems. The **Intel RST Premium With Intel Optane System Acceleration** mode allows the user to greatly accelerate SATA hard drive read/ write speeds by installing an Optane memory into the M.2 slot. Please refer to the section “**Intel RST Premium With Intel Optane System Acceleration**” for details.

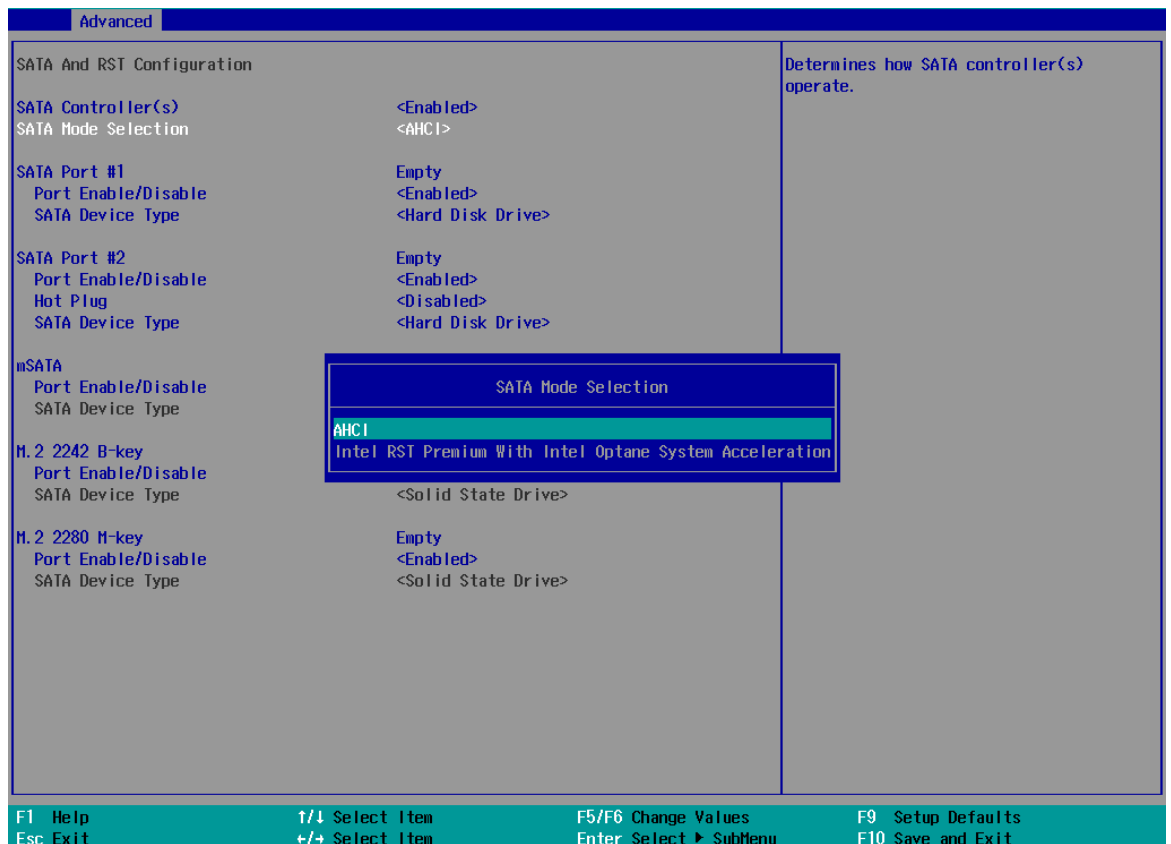

Recommended SATA controller mode settings:

- If you're using Windows 10 or Linux with kernel 4.15.18 or later, you can select **AHCI** mode for better performance.
- If you are looking for faster hard drive read/ write performance, please install an SSD (M.2, mPCIe, SATA) or install an Intel Optane memory for hard drive acceleration.

To set SATA controller mode:

1. When system boots up, press F2 to enter BIOS setup utility.
2. Go to **[Advanced] > [SATA And RST Configuration]**.

- Highlight the SATA, mSATA or M.2 port you wish to set and press ENTER to bring up setting options. Scroll to and highlight the setting you wish to set and press ENTER.

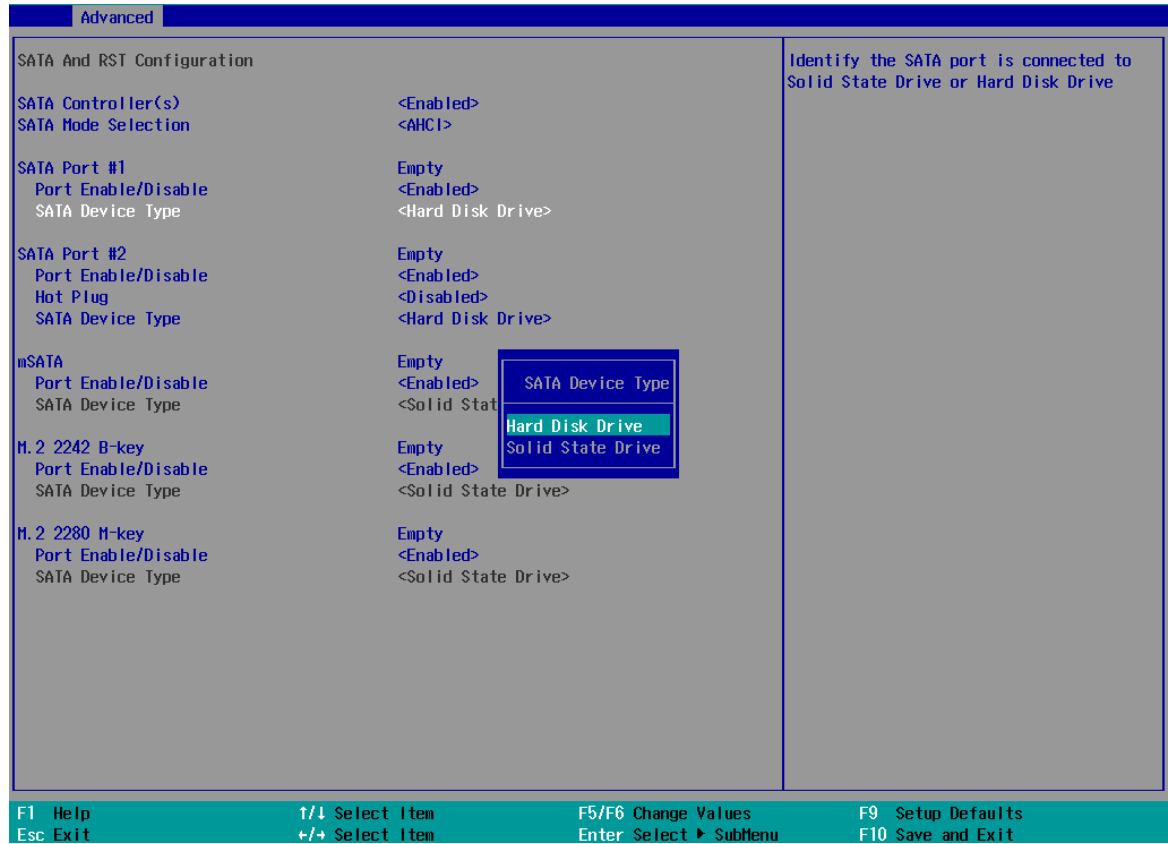

- Repeat step 3 to set other SATA ports.
- Press F10 to "Exit Saving Changes".

4.1.5 TPM Availability

Trusted Platform Module (TPM) is a hardware-based cryptoprocessor to secure hardware by integrating cryptographic keys into devices. The system is designed with on-board TPM 2.0 module. As TPM 2.0 requires 64-bit Windows 10 with UEFI boot mode, it is disable in BIOS by default. For customers who want to utilize TPM feature, you will need to enable TPM in BIOS as well as install Windows with UEFI mode.



To enable TPM availability:

1. When system boots up, press F2 to enter BIOS setup utility.
2. Go to **[Security] > [TPM Availability]**, press ENTER to bring up Options, Available/Hidden.
3. Highlight your selection, press Enter and press F10 to “Exit Saving Changes”.

4.1.6 Auto Wake on S5

When the system is set to operate in S5 state, the user can specify a time to turn on the system, daily or monthly.



Value	Option	Description
Auto Wake on S5	Disabled	The system does not turn on when operating in state S5.
	By Every Day	The system turns on each day when operating in state S5. Specify the time of day.
	By Day of Month	The system turns on each month when operating in state S5. Specify the day and time.

Highlight your selection, press ENTER and press F10 to “Exit Saving Changes”.

4.1.7 Power On After Power Failure Option

This option defines the behavior of System series when DC power is supplied.

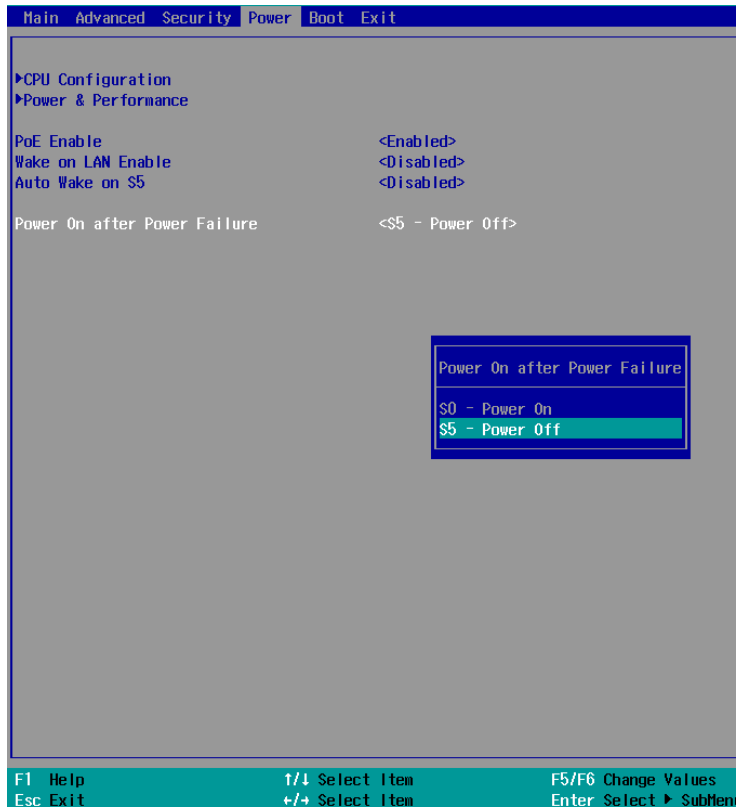

Value	Description
S0 – Power On	System is powered on when DC power is supplied.
S5 – Power Off	System is kept in off state when DC power is supplied.

To set “Power On after Power Failure” option:

1. When system boots up, press F2 to enter BIOS setup utility.
2. Go to **[Power] > [Power On after Power Failure]**.
3. Scroll down to highlight **[Power On after Power Failure]**, press ENTER to bring up setting options, S0 – Power On or S5 – Power Off, and press ENTER to select the setting.
4. Press F10 to “Exit Saving Changes”.

4.1.8 Power & Performance (CPU SKU Power Configuration)

The system supports various 8th-Gen Coffee Lake LGA1151 CPUs. A unique feature, “**SKU Power Config**” is implemented in BIOS to allow users to specific user-defined SKU power limit. Although the system is designed to have best thermal performance with CPUs of 35W TDP, you can install a 65W CPU and limit its SKU power (to 35W) to obtain more computing power. This feature gives you the flexibility of CPU selection and great balance between computing power and operating temperature range.

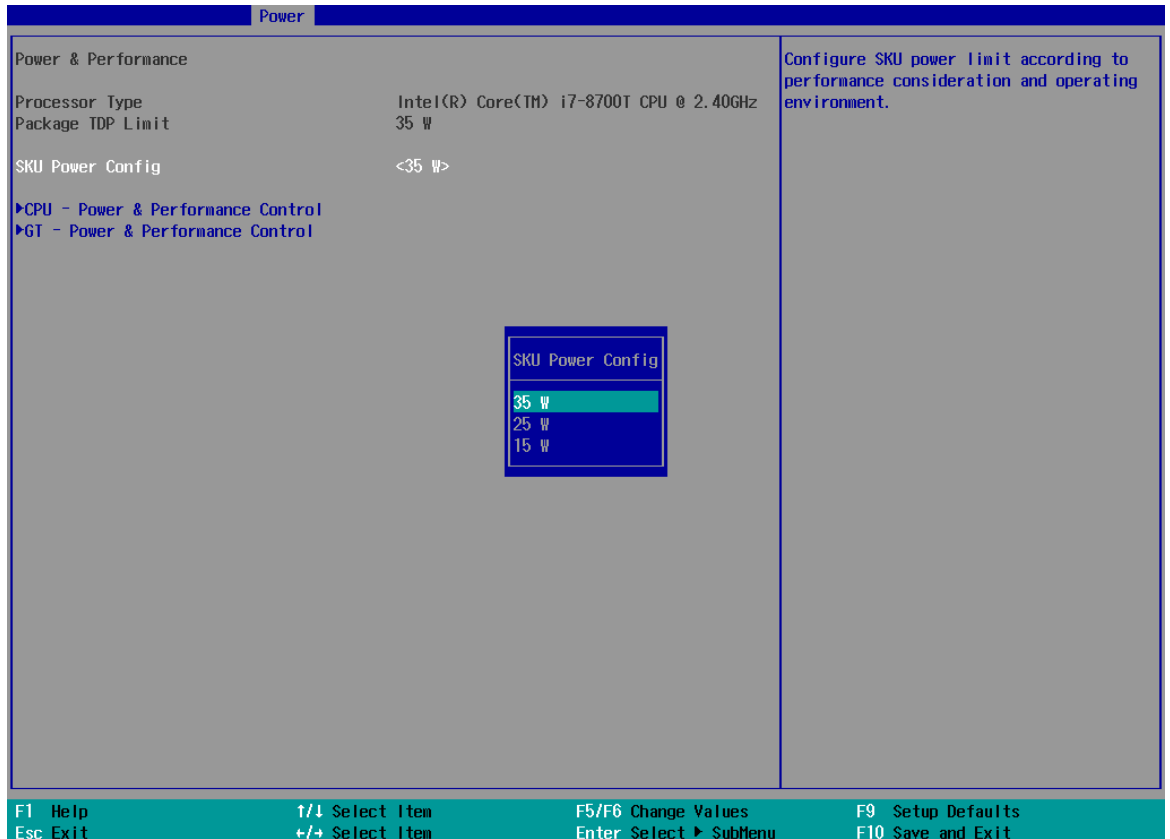

To configure the CPU SKU power limit:

1. When the system boots up, press F2 to enter BIOS setup utility.
2. Go to **[Power]** → **[Power & Performance]**.
3. Select a proper value of SKU power limit for **[SKU Power Config]** option.
4. Press F10 to “Exit Saving Changes”.

4.1.9 Wake on LAN Option

Wake-on-LAN (WOL) is a mechanism which allows you to turn on your System series via Ethernet connection. To utilize Wake-on-LAN function, you have to enable this option first in BIOS settings. Please refer "[Powering On Using Wake-on-LAN](#)" to set up the system.

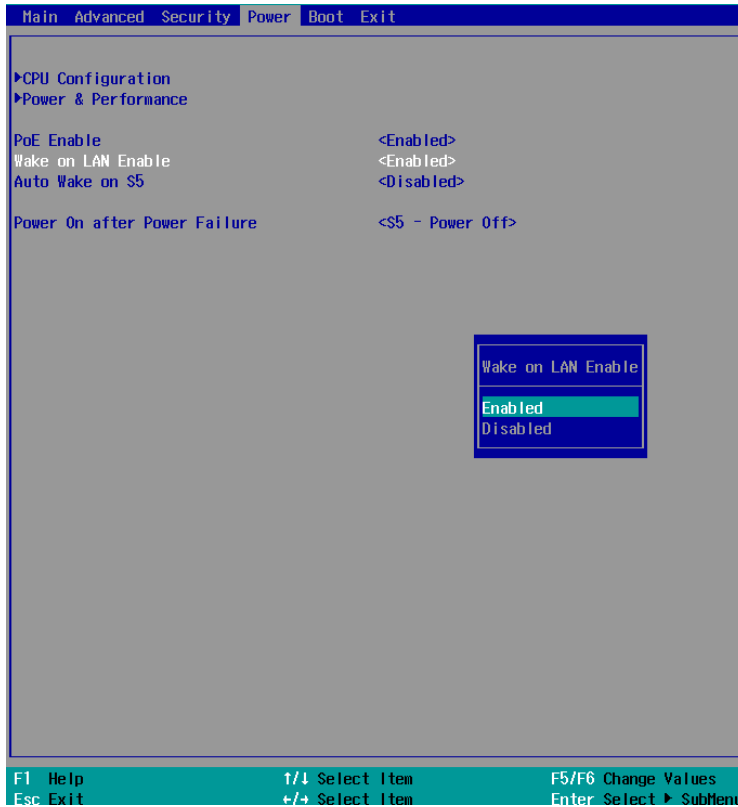

To enable/ disable “Wake on LAN” option:

1. When system boots up, press F2 to enter BIOS setup utility.
2. Go to **[Power] > [Wake on LAN]**.
3. Press ENTER to bring up setting options, scroll to the setting you desire and press Enter to set.
4. Press F10 to “Exit Saving Changes.

4.1.10 Boot Menu

The Boot menu in BIOS allows you to specify the system’s boot characteristics by setting bootable device components (boot media) and method. Or, you may press F12 upon system start up and select a device you wish boot from.





Value	Option	Description
Boot Type	Dual Boot Type	Both legacy and EFI boot media listed are approved as boot media.
	Legacy Boot Type	Only legacy boot media listed are approved as boot media.
	UEFI Boot Type	Only legacy boot media listed are approved as boot media.
Quick Boot	Enabled	The system starts up faster because BIOS skips various hardware function tests
	Disabled	The system starts up slower because BIOS goes through various hardware functions tests
Network Stack	Enabled	The system is available for network access using UEFI.
	Disabled	The system is not available for network access using UEFI.

PXE Boot capability	Disabled	Only UEFI Network Stack is supported: Preboot eXecution Environment (PXE) is not supported
	Enabled	By enabling the PXE boot, one can choose to boot via I219 Only/ I210 Only or All NICs .
Add Boot Options	First	Newly detected boot media are placed at the top of the boot order.
	Last	Newly detected boot media are placed at the bottom of the boot order.
ACPI Selection	1.0B/ 3.0/ 4.0/ 5.0/ 6.0	Advanced Configuration and Power Interface allows the operating system to control system power management
USB Boot	Enabled	Allow boot from bootable USB devices.
	Disabled	Does not allow boot from bootable USB devices
EFI Device First	Enabled	Set to boot bootable EFI media first.
	Disabled	Will not boot bootable EFI media first.
Timeout	1, 2, 3, etc (in seconds)	Boot delay time in seconds to give the user time to activate the hotkey to access the BIOS
Automatic Failover	Enabled	Automatically checks for the next bootable device when the set default device fails.
	Disabled	Will only boot from the designated device.
WDT for booting	Disabled, 1, 3, 5, 10 (minutes)	WDT ensures a successful system boot by specifying a timeout value

4.1.11 Boot Type (Legacy/ UEFI)

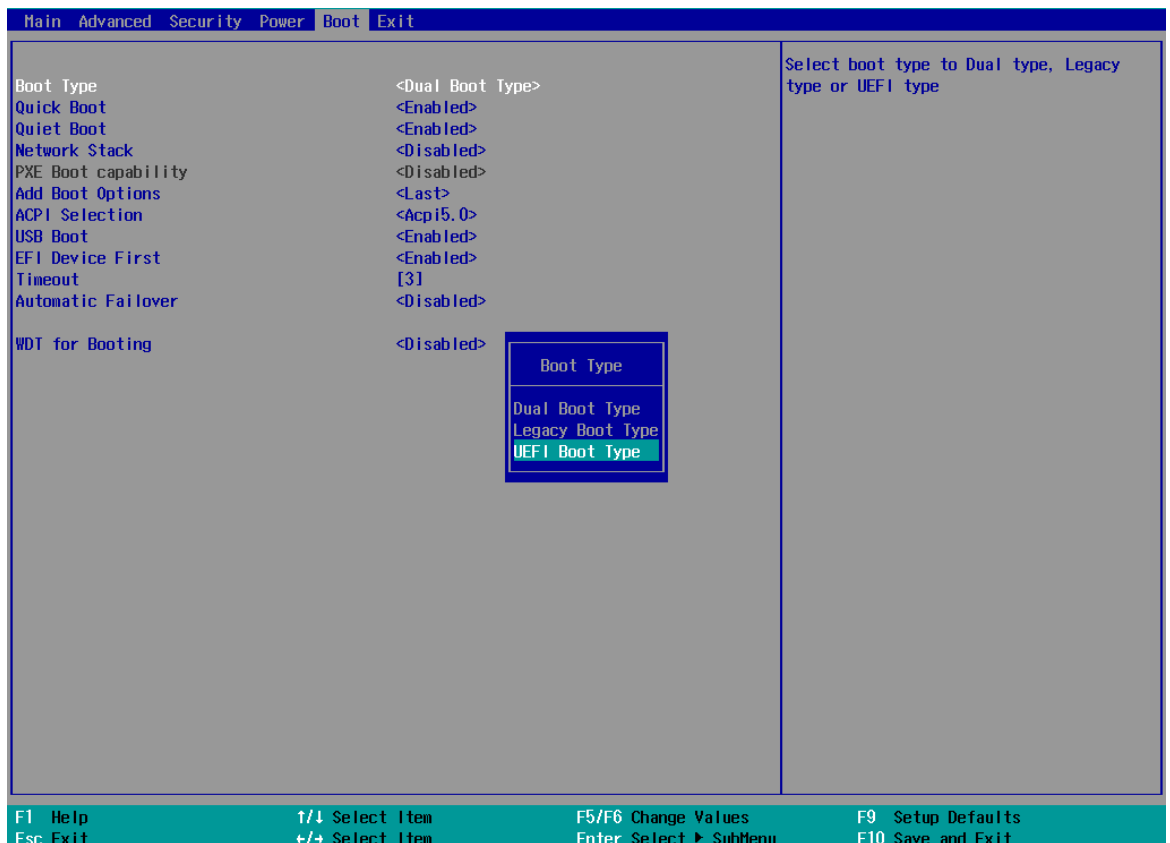
The system supports both Legacy and Unified Extensible Firmware Interface (UEFI) boot modes. UEFI is a specification proposed by Intel to define a software interface between operating system and platform firmware. Most modern operating systems, such as Windows 10 and Linux support both Legacy and UEFI boot modes. The Legacy boot mode uses MBR partition for disk and VBIOS for video initialization, the UEFI boot mode uses GPT partition which supports greater than 2TB partition size and GOP driver for faster video initialization.



 **NOTE**

If you choose Legacy mode, you will not be able to create disk partitions greater than 2TB or use TPM 2.0 function.

To configure Boot Type:

1. When system boots up, press F2 to enter BIOS setup utility.
2. Go to **[Boot]>[Boot Type]**, press ENTER to bring up options, Dual Boot (Legacy+UEFI), Legacy Boot Type, UEFI Boot Type.
3. Highlight your selection and press ENTER.
4. Press F10 to “Exit Saving Changes”.

4.1.12 Position New Boot Device

The “Add Boot Options” allow you to determine whether a newly added device (eg. USB flash disk) is to boot as the first device to boot or the last in the boot sequence.

To set the newly-installed boot device as the first or last boot device:

1. Press **F2** when the system boots up to enter the BIOS setup utility.
2. Go to **[Boot] > [Add Boot Options]** menu.
3. Select **[First]** or **[Last]** for your newly-added boot device and press ENTER.

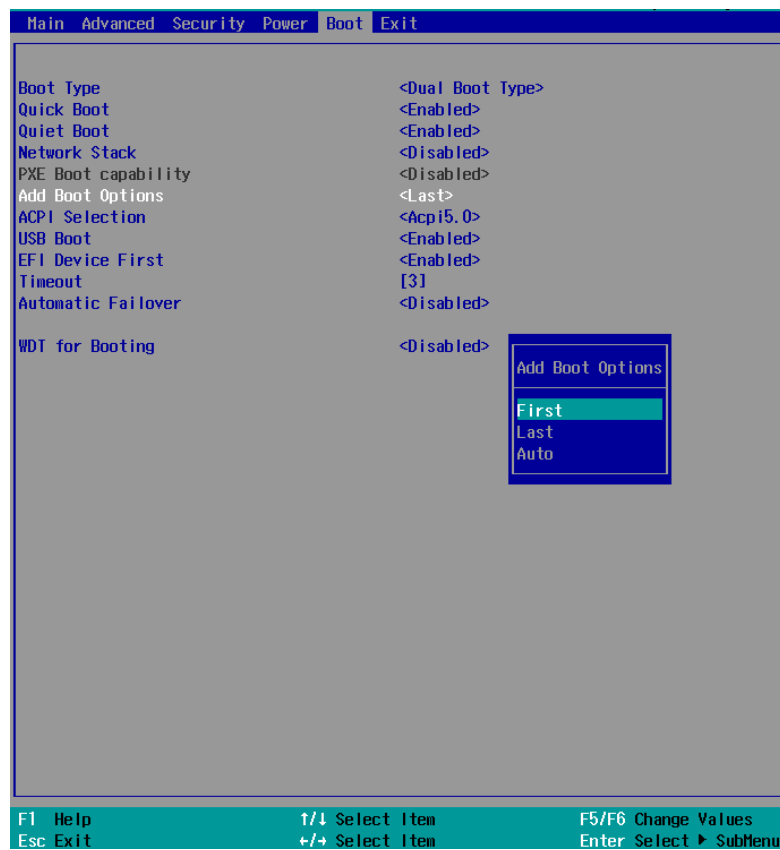

4. Once set, press **F10** to save setting and exit.

4.1.13 Watchdog Timer for Booting

The watchdog timer secures the boot process by means of a timer. Once the timer expires, a reset command is issued to initiate another booting process. There are two options in BIOS menu, “*Automatically after POST*” and “*Manually after Entering OS*”. When “*Automatically after POST*” is selected, the BIOS automatically stops the watchdog timer after POST (Power-On Self Test) OK. When “*Manually after Entering OS*” is selected, the user must stop the watchdog timer once booted into the OS. This guarantees the system can always boot into the OS, otherwise another booting process will be initiated. For information about programming watchdog timer, please refer to [Watchdog Timer & Isolated DIO](#).



To set the watchdog timer for boot in BIOS:

1. When system boots up, press F2 to enter BIOS setup utility.
2. Go to **[Boot]** menu.
3. Disable or select timeout value for **[WDT for Booting]** option.
4. Once you give a timeout value, the **[WDT Stop Option]** option appears. You can select “*Automatically after POST*” or “*Manually after Entering OS*”.
5. Press F10 to “Exit Saving Changes.

4.1.14 Legacy/ UEFI Boot Device

When you wish to set a designated boot device, you may set it as the first device to boot in Legacy or UEFI Boot Device setting. Or if you wish to manually select a boot device, you may do so by pressing F12 when the system boots up.



To set boot order for devices in UEFI Boot Device:

1. When system boots up, press F2 to enter BIOS setup utility
2. Go to **[Boot] > [UEFI]**
3. Highlight the device you wish to make boot order changes to and press F5/ F6 or +/- to change device boot order.

To select boot order for devices in Legacy Boot Device:

1. When system boots up, press F2 to enter BIOS setup utility
2. Go to **[Boot] > [Legacy]**, you can choose the type of device to list by selecting “By Device or By Device Type”.
3. Highlight the device you wish to make boot order changes to and press F5/ F6 or +/- to change device boot order.

4.2 AMT Configuration

Intel® AMT (Active Management Technology) is a hardware-based technology for remotely managing target PCs via Ethernet connection. The system supports AMT function via its Ethernet port implemented with Intel I219-LM. Prior to using the AMT function to remotely control the system, you need to configure AMT password and network settings.

1. Connect Ethernet cable to I219-LM Ethernet port (indicated in blue).

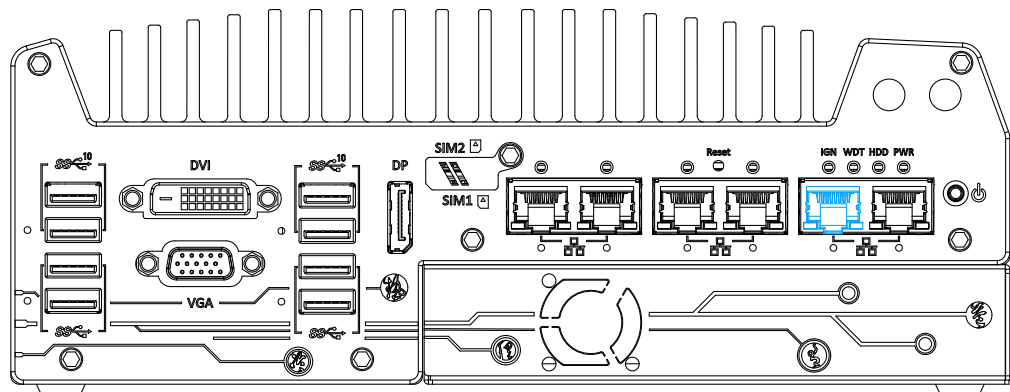

2. When the system boots up, press F10 to enter the MEBx configuration menu.

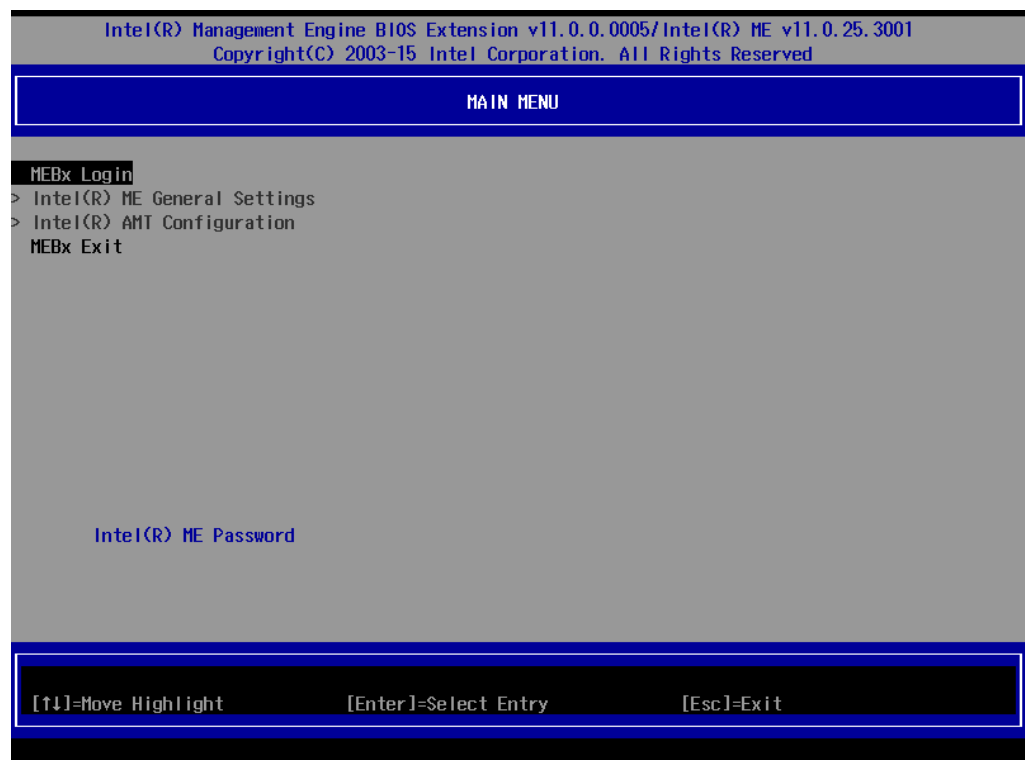

3. Highlight MEBx Login and press Enter, a prompt will appear asking for password. The default password is "admin". For further MEBx configuration details, please refer to [Intel® MEBX User Guide](#).

4.3 RAID Configuration

To set up a RAID 0 or 1 volume in Legacy or UEFI mode, you need to have at least two hard drives or SSDs installed. The system supports RAID configurations in RAID 0 (striping) or RAID 1 (mirror) mode. Users can select the configuration that best suit their needs with RAID 0 (striping) mode offering better hard drive read/ write performances while RAID 1 (mirror) offers better data security.

 **WARNING**

Please back up the hard drive data before you create or modify RAID volume(s) as the process may cause irreversible data deletion. When creating a RAID volume, it is also recommended to use hard drives from the same batch (same brand, model, capacity, rpm rate, etc.) to avoid performance or capacity allocation issues.

4.3.1 Legacy Mode RAID Configuration

To set up RAID configuration, you need to pre-configure the SATA mode setting in the BIOS. Please refer to the following steps:

1. When system boots up, press **F2** to enter BIOS setup utility.
2. Go to **[Advanced] > [SATA And RST Configuration] > [SATA Mode Selection]** > highlight **[Intel RST Premium With Intel Optane System Acceleration]** and press ENTER.

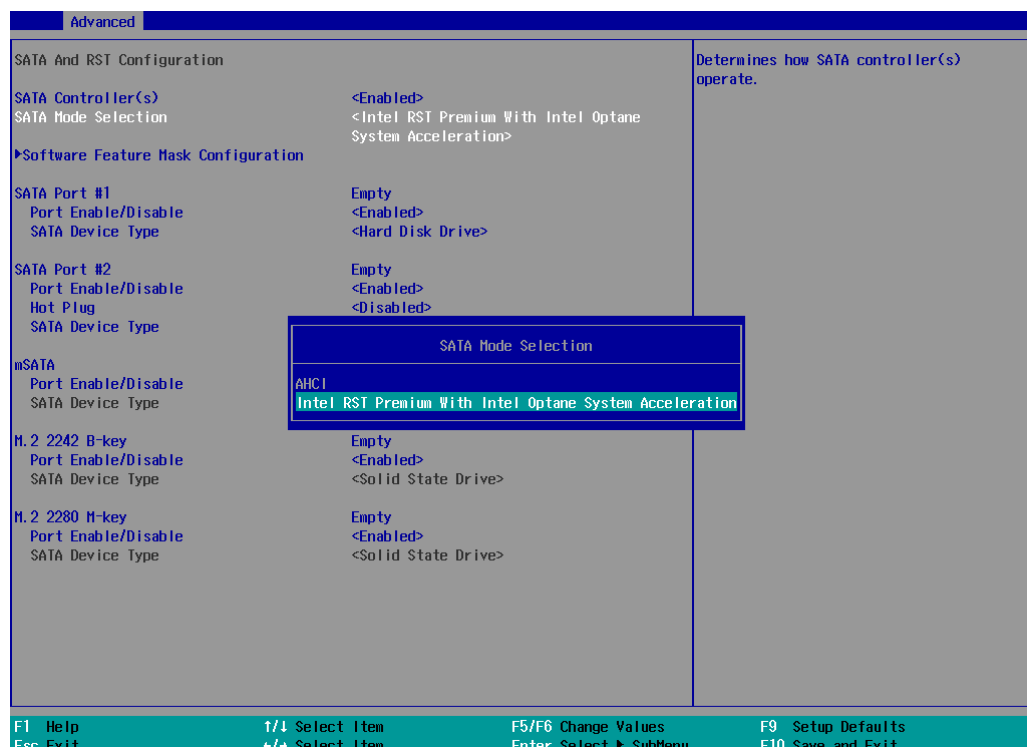

- Go to [Boot] > highlight [**Legacy Boot Type**] and press ENTER to set boot type.

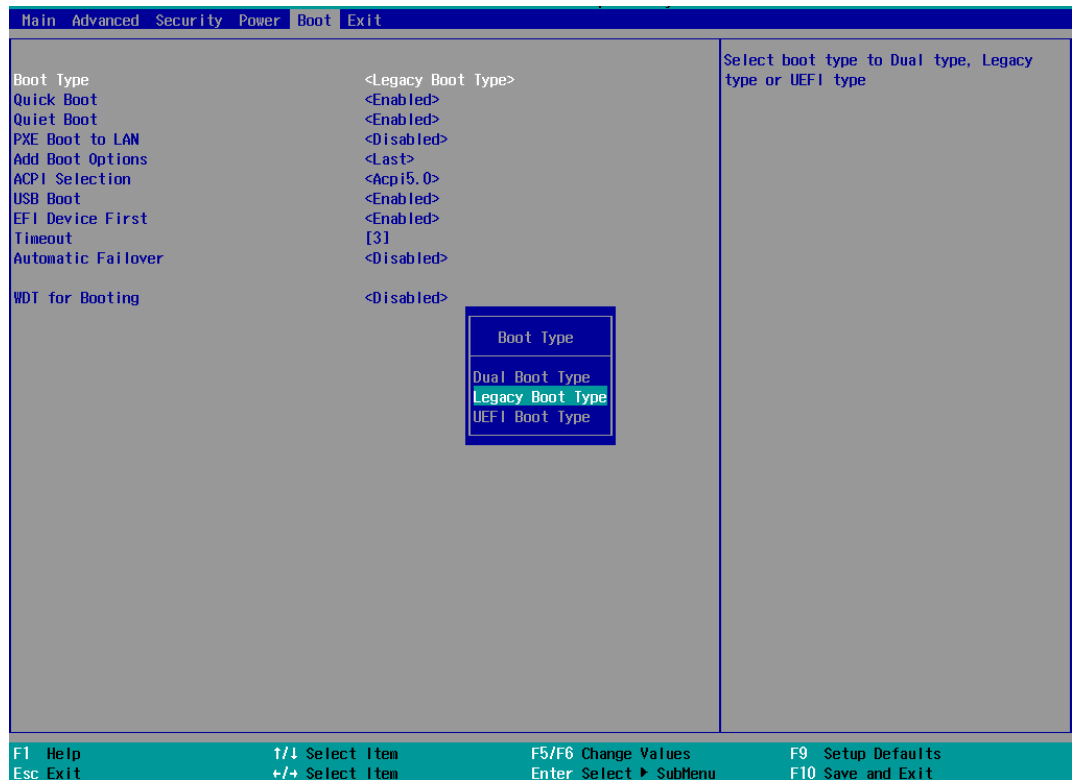

- Press F10 to "Exit Saving Changes" and reboot the system.
- When the system reboots, press [**Ctrl + I**] to enter the RAID configuration utility.
- Once you're in the Configuration Utility, highlight [**Create RAID Volume**] and press ENTER.

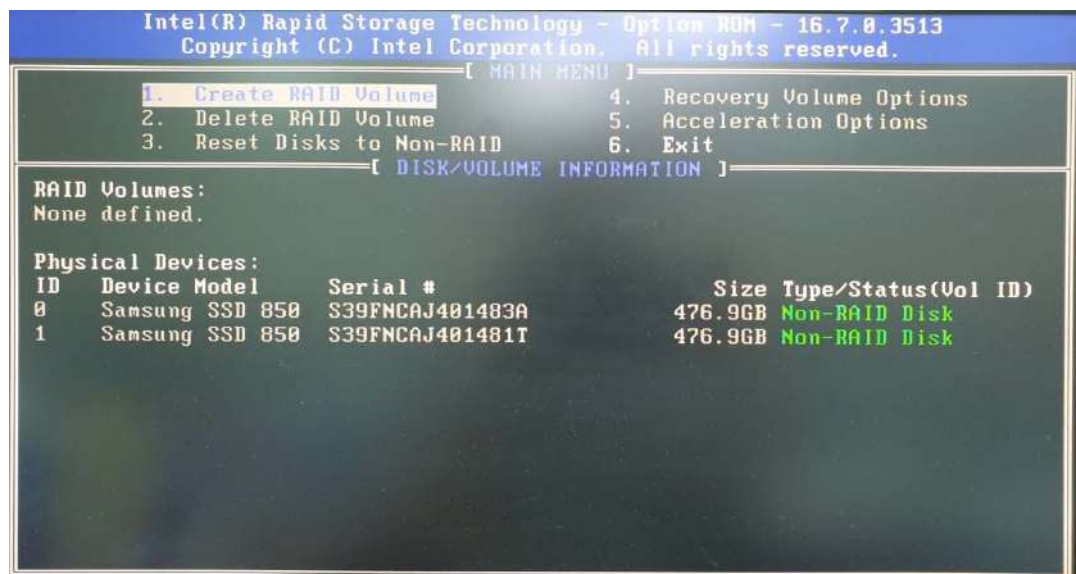

7. The following screen allows you to enter the **Name** of the RAID volume you wish to create. Enter a name and press ENTER to access the **RAID Level** setting.

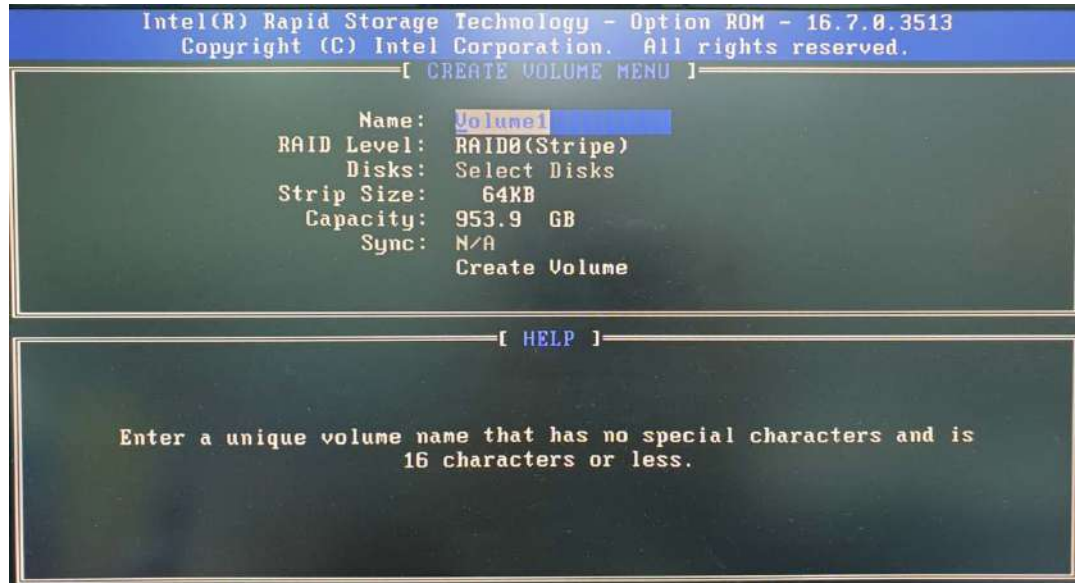

8. For **RAID Level**, use the up and down arrow key to select between **RAID0 (Stripe)** or **RAID1 (Mirror)** settings. Select a RAID mode and press ENTER to access **Stripe Size** setting (not applicable to Mirror mode).



- For **Stripe Size**, use the up and down arrow key to select between 4KB, 8KB, 16KB, 32KB, 64KB, 128KB for your RAID volume stripe size and press ENTER to access the **Capacity** setting.

*RAID1(Mirror) does not offer Stripe Size options.

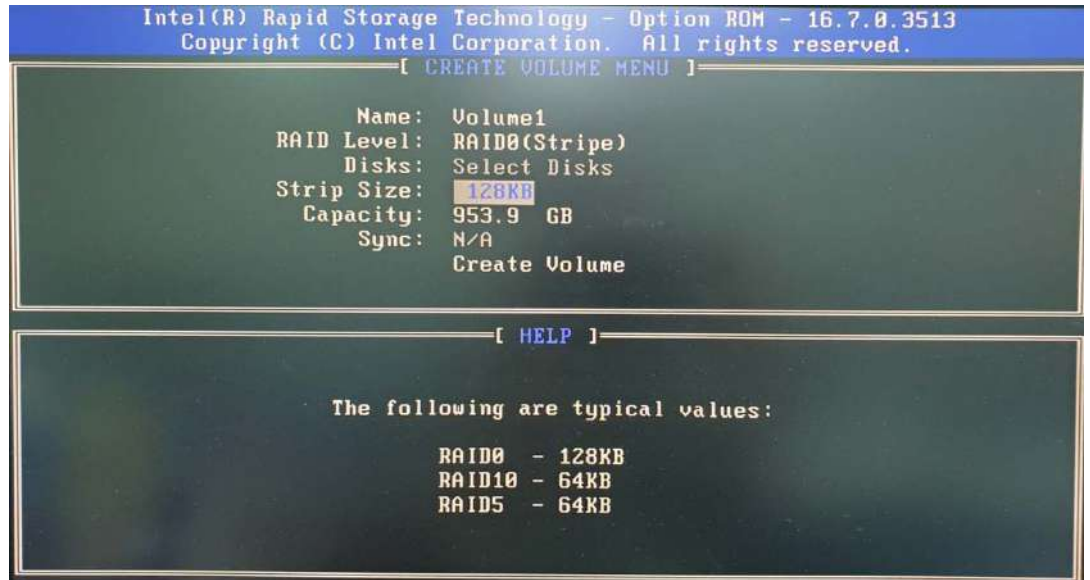

- You may enter the RAID volume capacity you wish to create at this step and press the Enter key to complete your RAID settings. By default, the maximum capacity will be applied. Once you have entered a capacity, press ENTER to confirm.

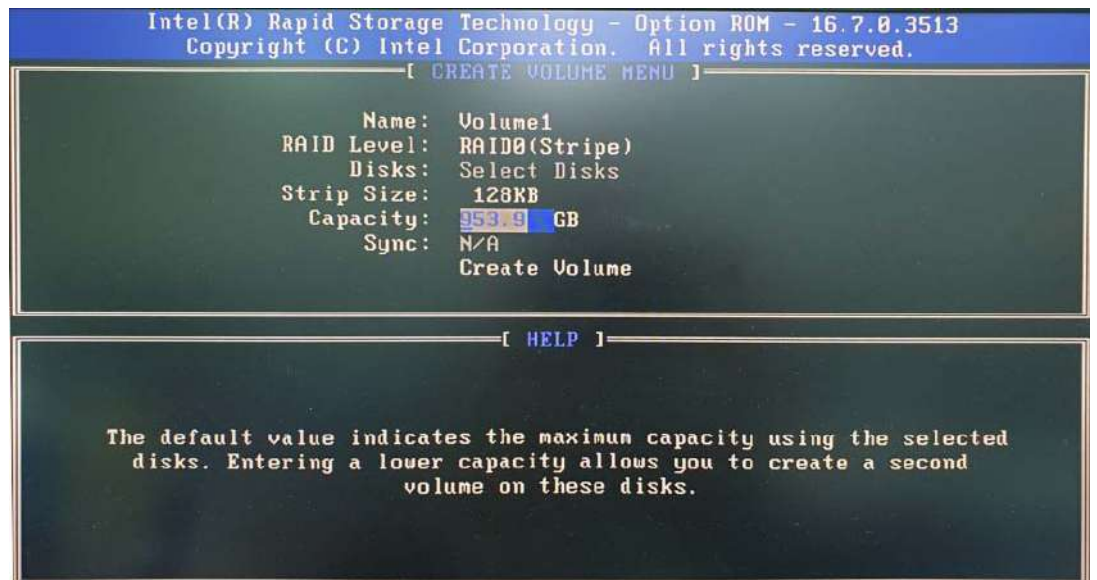

11. Reviewed your settings and if you wish to change any setting(s), you will need to press [ESC] and start again from **Step 5**. If all settings are correct and you wish to continue, with “**Create Volume**” highlighted, press ENTER to begin creating the RAID volume.

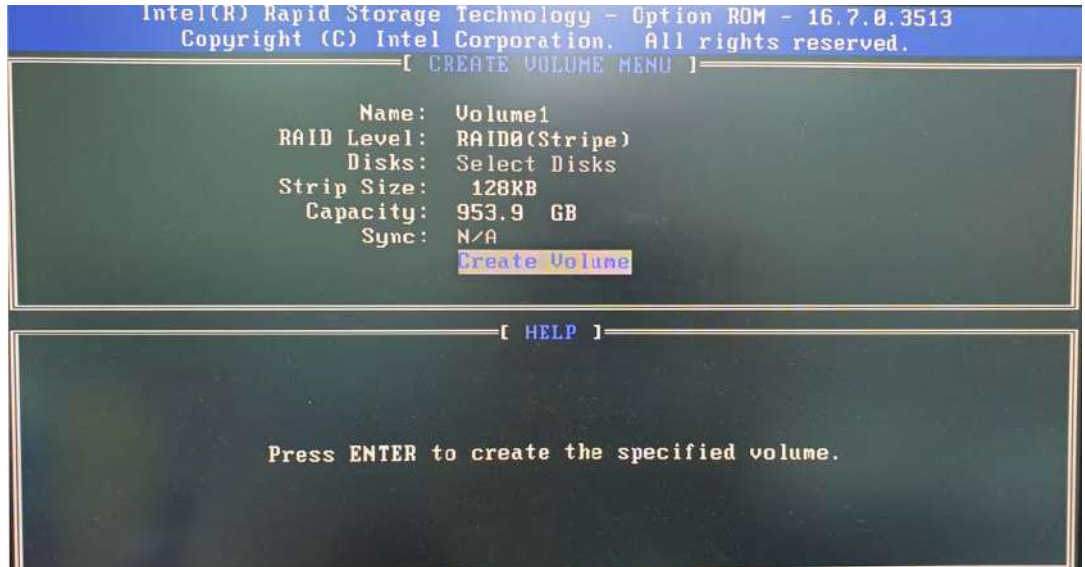

12. A data deletion warning will appear, enter “Y” to continue and “N” to stop the volume creation process.

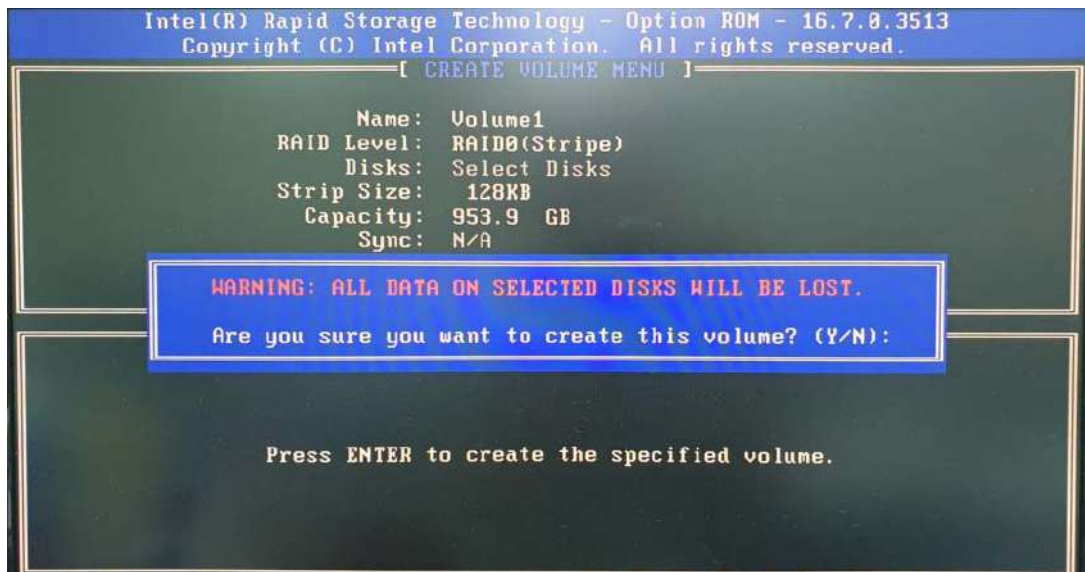

13. Once the RAID volume has been created, the configuration utility will bring you back to the main screen showing the RAID volume and their member disks.

```

Intel(R) Rapid Storage Technology - Option ROM - 16.7.0.3513
Copyright (C) Intel Corporation. All rights reserved.

[ MAIN MENU ]
1. Create RAID Volume
2. Delete RAID Volume
3. Reset Disks to Non-RAID
4. Recovery Volume Options
5. Acceleration Options
6. Exit

[ DISK/VOLUME INFORMATION ]

RAID Volumes:
ID Name Level Strip Size Status Bootable
0 Volume1 RAID0(Stripe) 128KB 953.9GB Normal Yes

Physical Devices:
ID Device Model Serial # Size Type/Status(Vol ID)
0 Samsung SSD 850 S39FNCAJ401483A 476.9GB Member Disk(0)
1 Samsung SSD 850 S39FNCAJ401481F 476.9GB Member Disk(0)

```

14. The above process was to create a RAID-0 volume. If you wish to create a RAID-1 volume, please perform steps 5 to 13 in this section and select RAID-1 during step 8.

4.3.2 UEFI Mode RAID Configuration

To enable RAID functionality in UEFI mode:

1. When system boots up, press F2 to enter BIOS setup utility.
2. Go to **[Advanced] > [SATA And RST Configuration] > [SATA Mode Selection] > highlight [Intel RST Premium With Intel Optane System Acceleration]** and press ENTER.

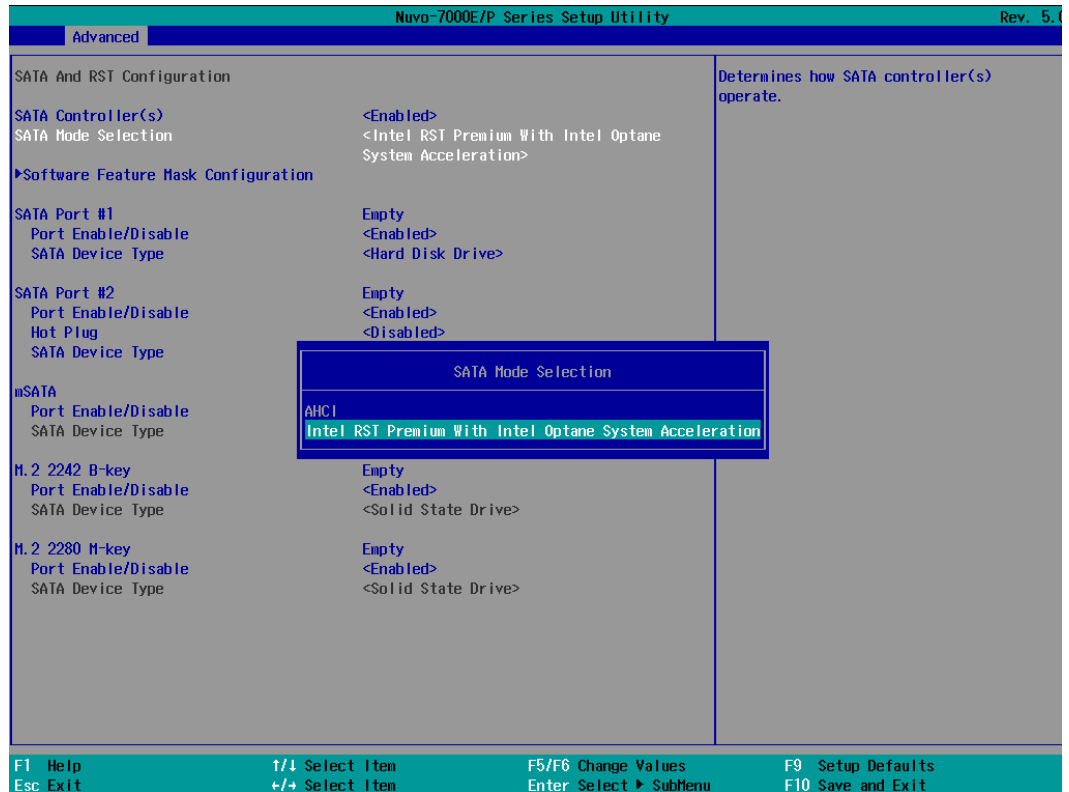

- Go to **[Boot]**, highlight **[UEFI Boot Type]** and press ENTER to set boot type.

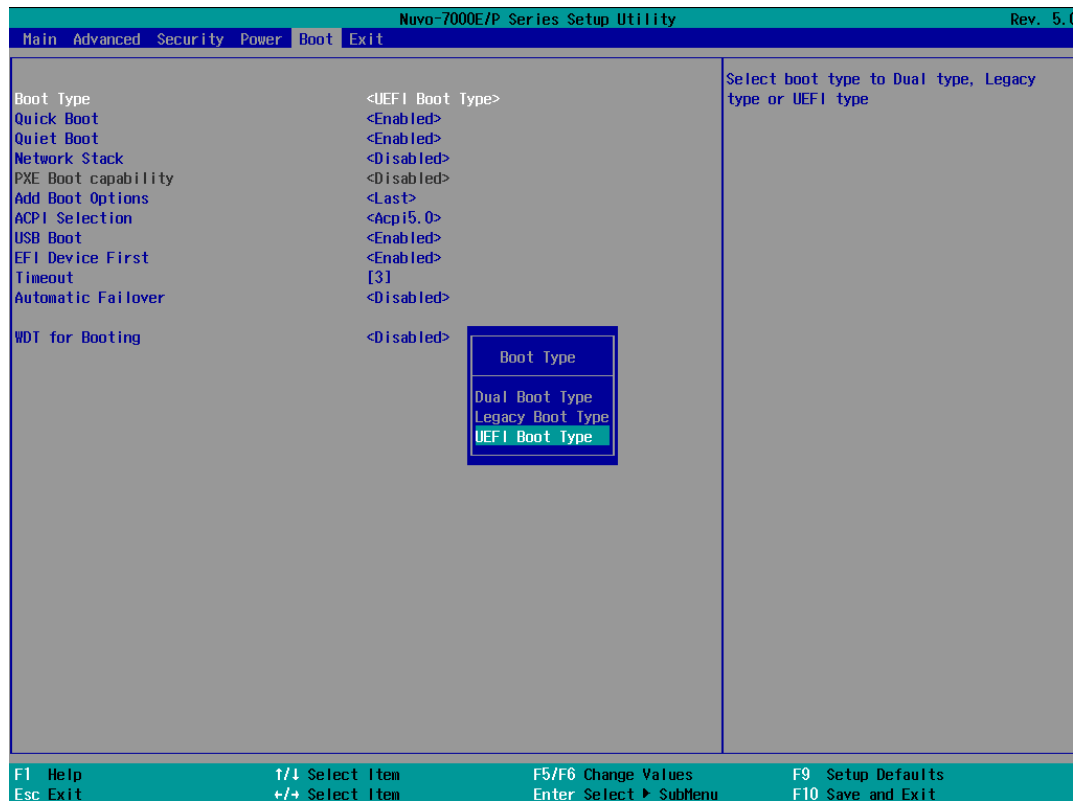

- Press F10 to “Exit Saving Changes” and reboot the system.
- When the system reboots, press **[F3]** to enter the Configuration Utility.
- Once you’re in the Configuration Utility, highlight **[Intel® Rapid Storage Technology]** and press ENTER.



7. The following screen shows Non-RAID physical disks and the option “**Create RAID Volume**”. Highlight “**Create RAID Volume**” and press ENTER to begin creating your RAID volume.

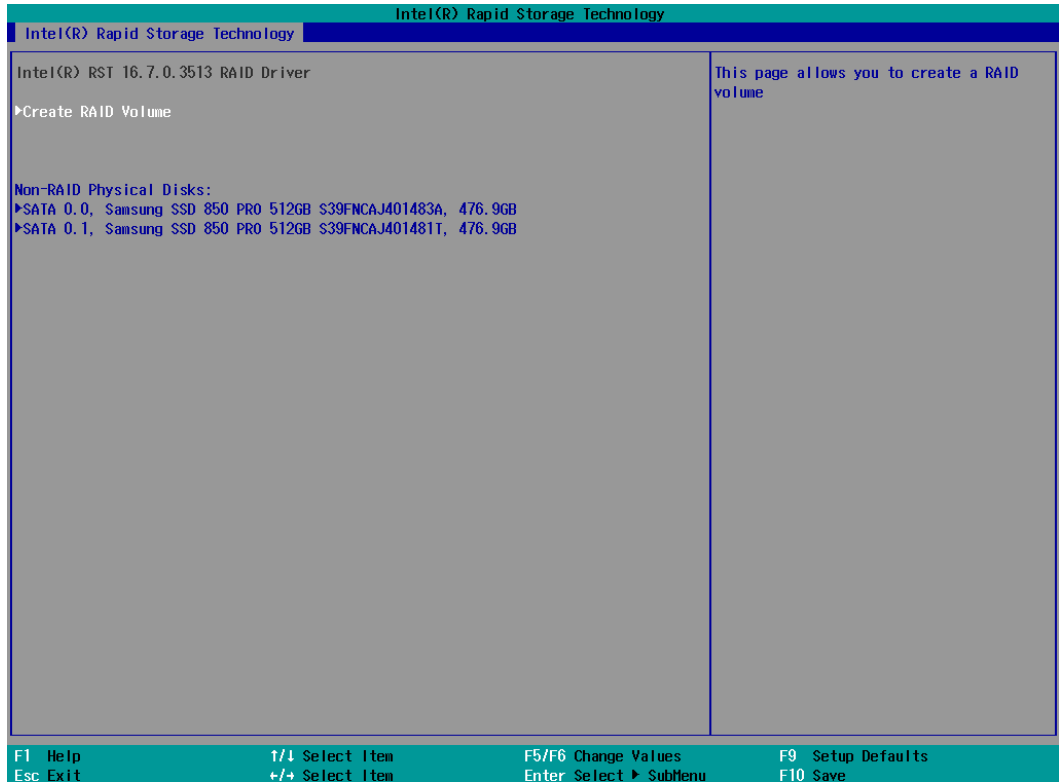

8. The Name option allows you to name your RAID volume. Press ENTER when ready to go to the next option.

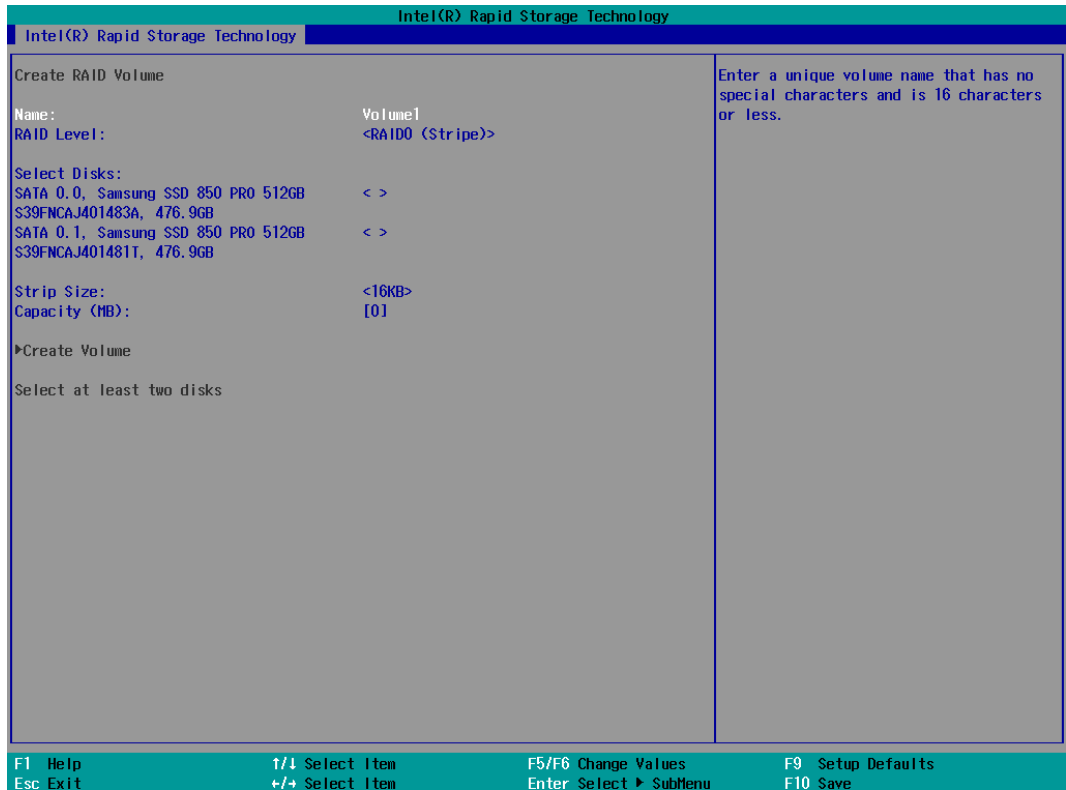

9. The RAID Level option allows you to select RAID-0 (striping) or RAID-1 (mirror) for your RAID volume. Press ENTER when ready.



10. The Select Disks option allows you to select disk drives for your RAID volume. Highlight a drive and press ENTER, use up/ down arrow keys to highlight "x" and press ENTER to confirm the selection. A minimum of two disk drives must be selected for RAID-0 or RAID-1 configuration. Press ENTER when ready.

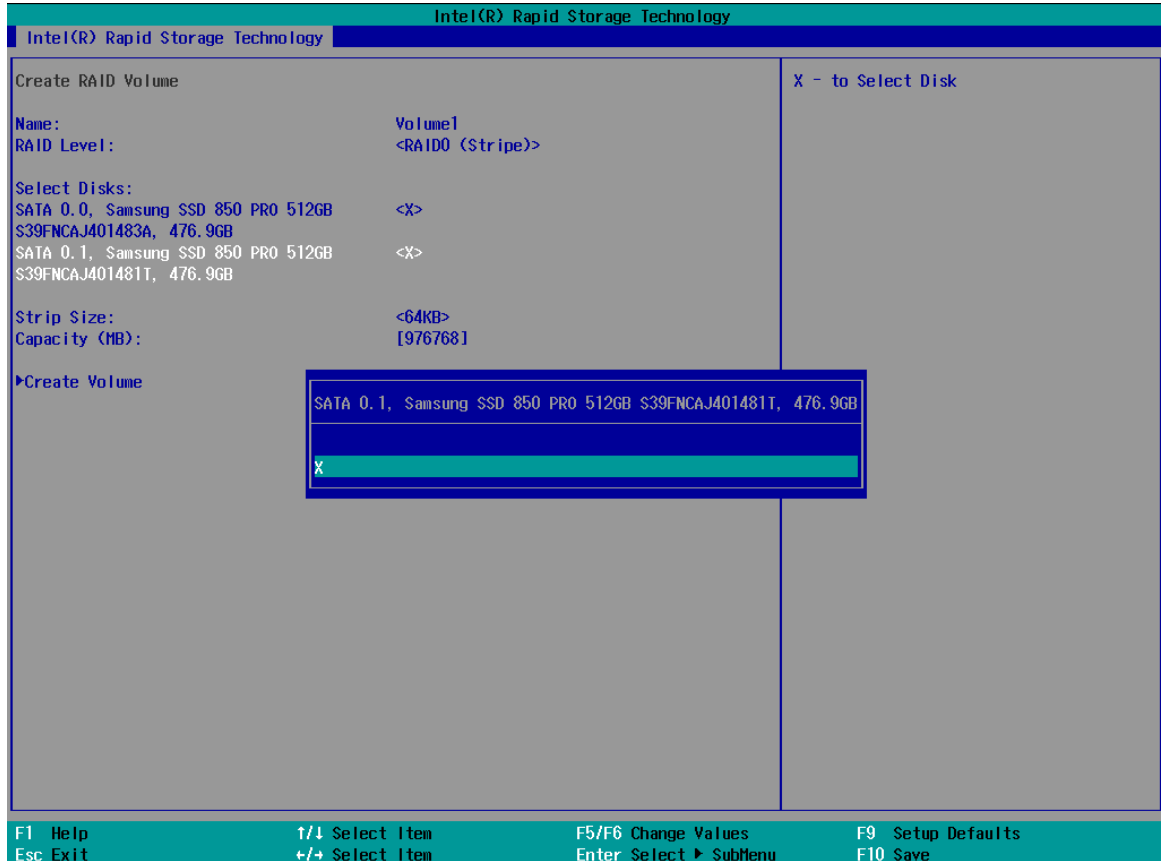

11. The Stripe Size option allows you to configure the stripe size of your RAID volume. Available stripe sizes are 4KB, 8KB, 16KB, 32KB, 64KB, 128KB, use the up and down arrow keys to highlight and press ENTER to confirm the stripe size selection.

*RAID1(Mirror) does not offer Stripe Size options.

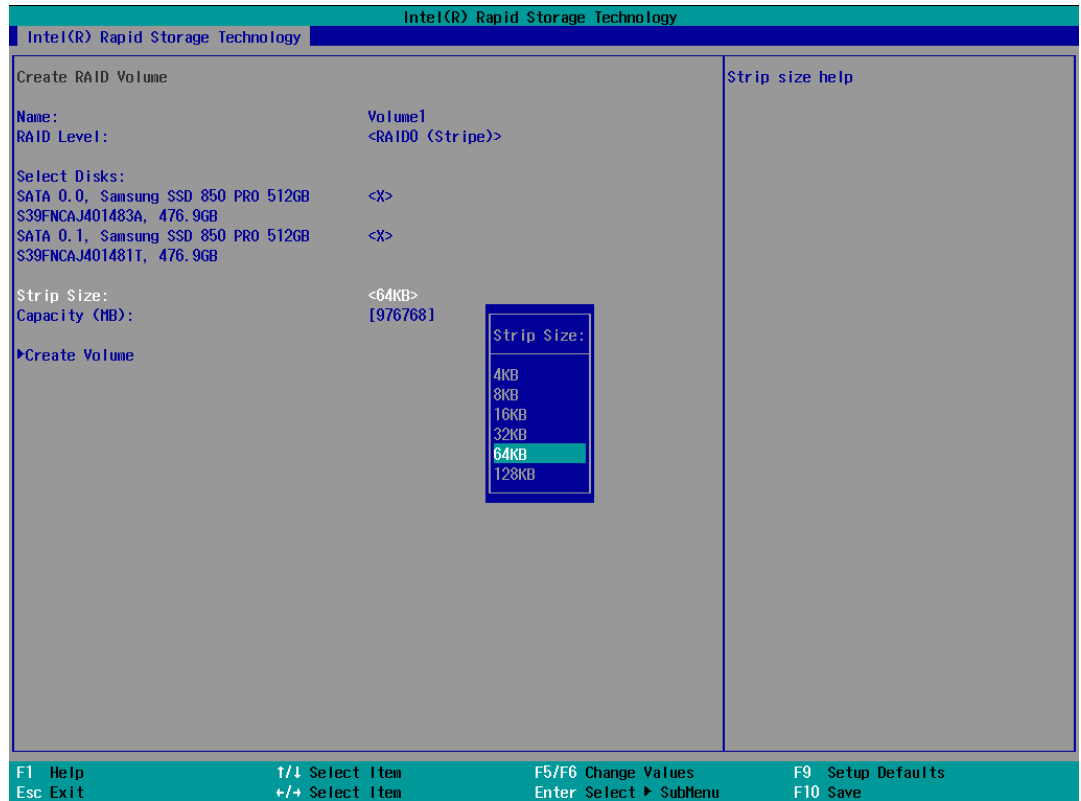

12. The Capacity (MB) option allows you to configure the storage capacity of your RAID volume. By default, the full storage capacity will be applied. Once you have entered a capacity, press ENTER to confirm.



- The Create Volume option is the final step in the volume creation process. Highlight **“Create Volume”** and press ENTER to begin creating your RAID volume base on the settings you just configured.

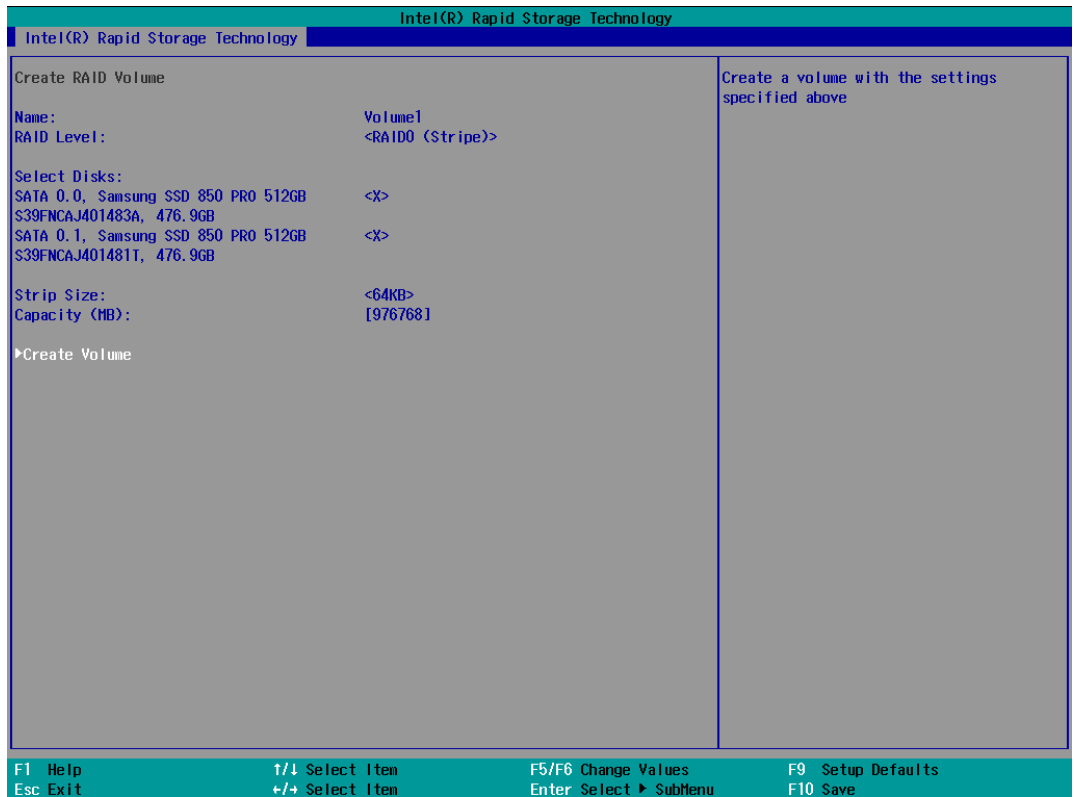

14. A summary and status of the RAID volume will be shown when the RAID volume is successfully created.

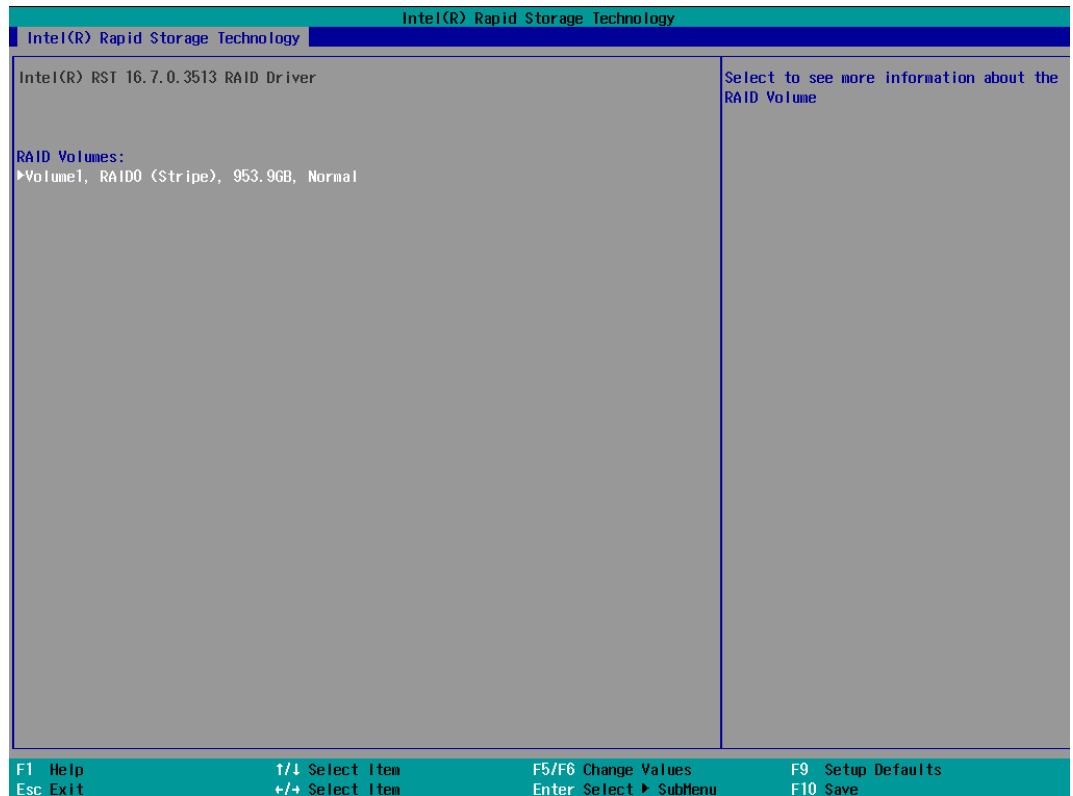

15. Press F10 to save and Esc to exit the Intel® Rapid Storage Technology configuration page.



NOTE

The above process was to create a RAID-0 volume. If you wish to create a RAID-1 volume, please perform steps 5 to 13 in this section and select RAID-1 during step 9.

5 OS Support and Driver Installation

5.1 Operating System Compatibility

The system supports most operating system developed for Intel® x86 architecture. The following list contains the operating systems which have been tested by Neosys Technology.

- Microsoft Window 10 (x64)
- Fedora 29**
- Ubuntu 16.04.5 LTS & Ubuntu 18.04.0 LTS **



NOTE

For other Linux OS, Linux kernel should upgrade to 4.15.18.

** For Linux system, user may need to manually compile and install the driver for Intel graphics or I210 GbE controller if the driver is not embedded in kernel. You can visit Intel website for further information.*

*** For distributions, graphics driver and RAID function may not be completely implemented in its kernel. You may encounter restrictions when using these features, such as triple independent display and RAID. For optimum operation, it is the users' responsibility to manually check for new drivers and upgrades!*

Neosys may remove or update operating system compatibility without prior notice. Please contact us if your operating system of choice is not on the list.

5.2 Driver Installation

The system comes with a “Drivers & Utilities” DVD that offers “one-click” driver installation process. It automatically detects your Windows operating system and installs all necessary drivers for you system with a single click.

5.2.1 Install Drivers Automatically

The system comes with a “Drivers & Utilities” DVD that offers “one-click” driver installation process. It automatically detects your Windows operating system and installs all necessary drivers for you system with a single click.

To install drivers automatically, please refer to the following procedures.

1. Insert the “Drivers & Utilities” DVD into a USB DVD-drive connect to your system. A setup utility launches and the following dialog appears.



2. Click on “**Automatic Driver Installation**” and the setup utility will automatically detect your Windows operating system and install all necessary drivers. The installation process takes about 6~8 minutes depending on your Windows version. Once driver installation is done, the setup utility reboots your Windows and you may begin using your system.

5.2.2 Install Drivers Manually

You can also manually install each driver for the system. Please note when installing drivers manually, you need to install the drivers in the following sequence mentioned below.

Windows 10 (x64)

The recommended driver installation sequence is

1. Chipset driver (x:\Driver_Pool\Chipset_CFL\Win_10_64\SetupChipset.exe)
2. Graphics driver (x:\Driver_Pool\Graphics_CFL_SKL_APL\Win_10_64\igxpin.exe)
3. Audio driver (x:\Driver_Pool\Audio_ALC262\Win_ALL_64\Setup.exe)
4. LAN driver
(x:\Driver_Pool\GbE_I210_I350\Win_10_64_CFL\APPS\PROSETDX\Winx64\DxSetup.exe)
5. ME driver (x:\Driver_Pool\ME_CFL\Win_10_64\SetupME.exe)

5.3 Driver Installation for Watchdog Timer Control

Neosys provides a driver package which contain function APIs for Watchdog Timer control function. You should install the driver package (WDT_DIO_Setup.exe) in prior to use these functions. Please note that you must install WDT_DIO_Setup_v2.2.9.0 or later versions.

Windows 10 (x64)

Please execute the driver setup program in the following directory.

x:\Driver_Pool\WDT_DIO\Win7_8_10_64\WDT_DIO_Setup_v2.2.9.0(x64).exe

Windows 10 (WOW64)

Please execute the driver setup program in the following directory.

x:\Driver_Pool\WDT_DIO\Win7_8_10_WOW64\WDT_DIO_Setup_v2.2.9.0(wow64).exe

5.4 Intel® Optane™ Memory BIOS Setup and Driver

Installation

The system is compatible with Intel® Rapid Storage Technology that supports the installation of Intel® Optane™ memory to significantly boost traditional hard disk drive read and write performances. Intel® Optane™ memory is Intel® RST's latest system acceleration solution featuring a dual-media/disk combination (ultrafast media for file and block caching + slow media for storage capacity) that is presented to the host OS as a single SSD. The ultra fast media utilizes PCIe NVMe SSDs that are based on Intel® Optane™ technology with read/ write speed of up to 2000Mb/ sec.

To setup Intel® Optane memory, please perform the following steps:

1. Press the power button to startup your system (please restart if your system is already up and running) and press F2 to enter BIOS.
2. Go to "Advanced > SATA And RST Configuration".

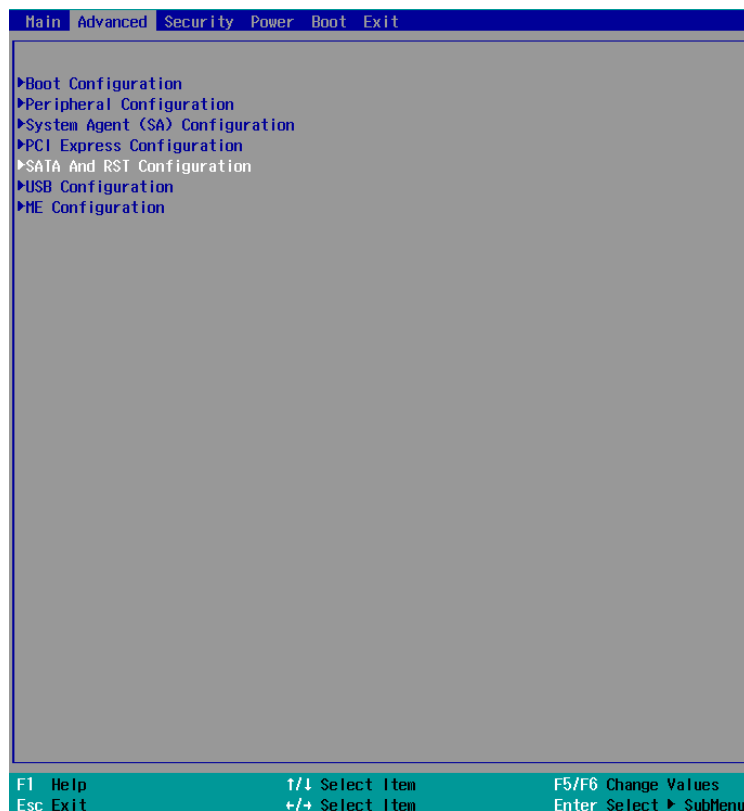

- Go to "SATA Mode Selection", press ENTER to bring up options, select "Intel RST Premium With Intel Optane System Acceleration" and press ENTER to select the option.

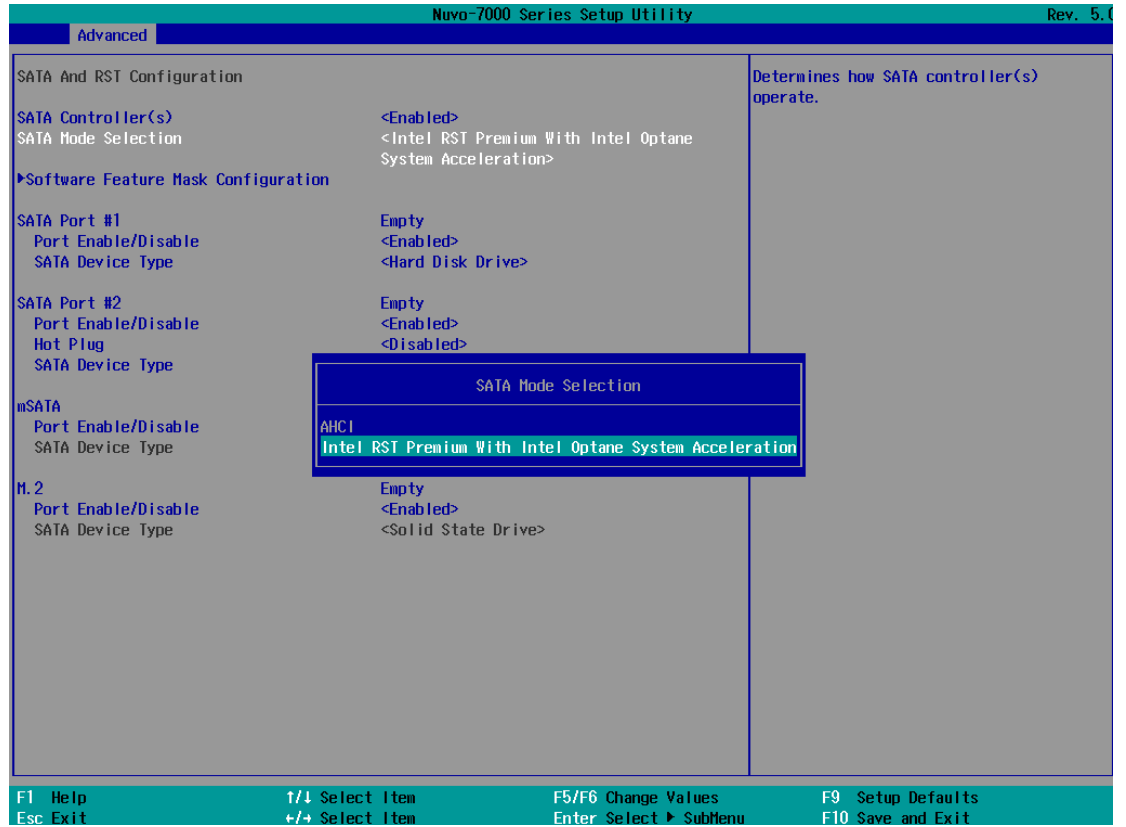

- Go to “M.2 2280 NVMe Storage Device” and press ENTER to bring up the selection, select “RST Controlled” and press ENTER to select the option.



- Press F10 to save and exit, and allow the system to boot into Windows.
- In Windows, download [Intel® RST driver](#) if you don't already have it on hand.



Right-click on the SetupOptaneMemory.exe and left-click on “Run as administrator” to execute the setup file.

7. Follow the 6-step setup procedure as instructed.

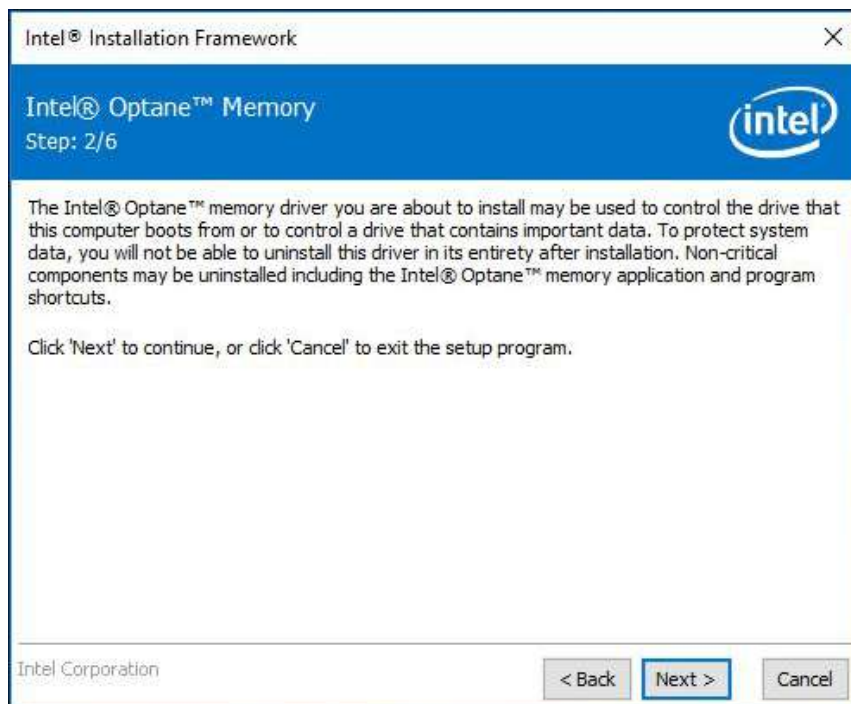
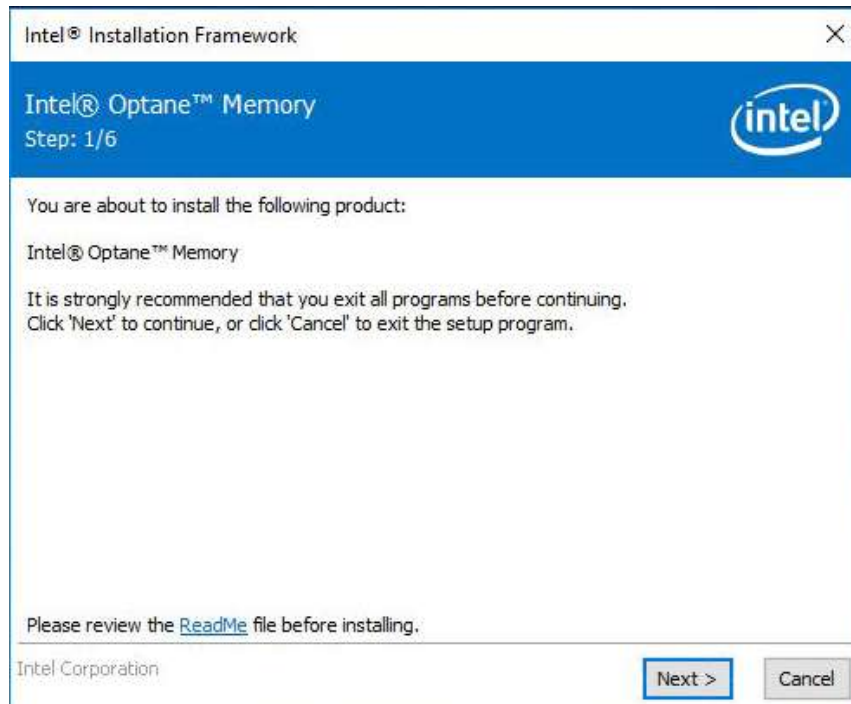

8. Check the "I accept the terms in the License Agreement" box and click on "Next >" to continue the installation process.

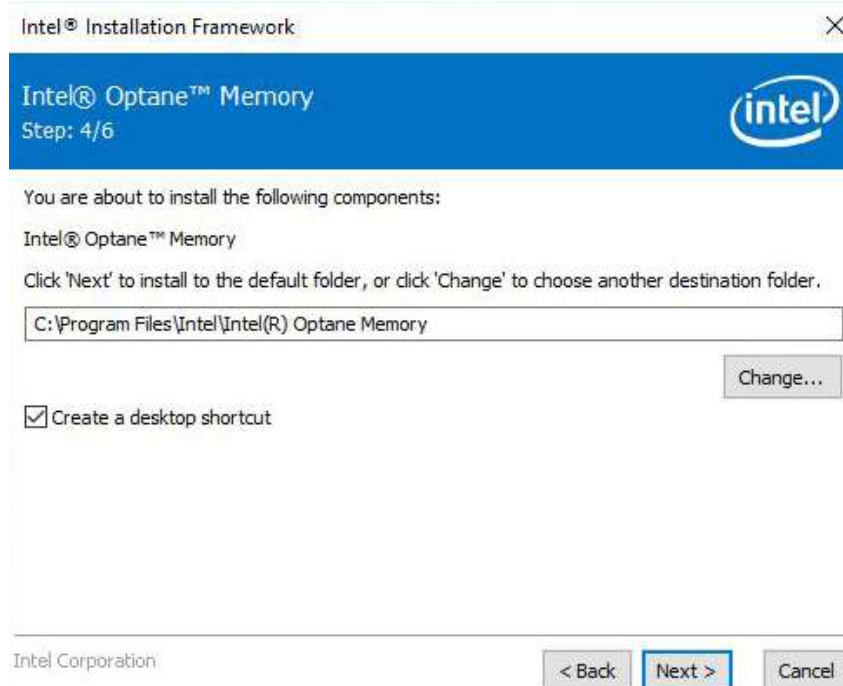
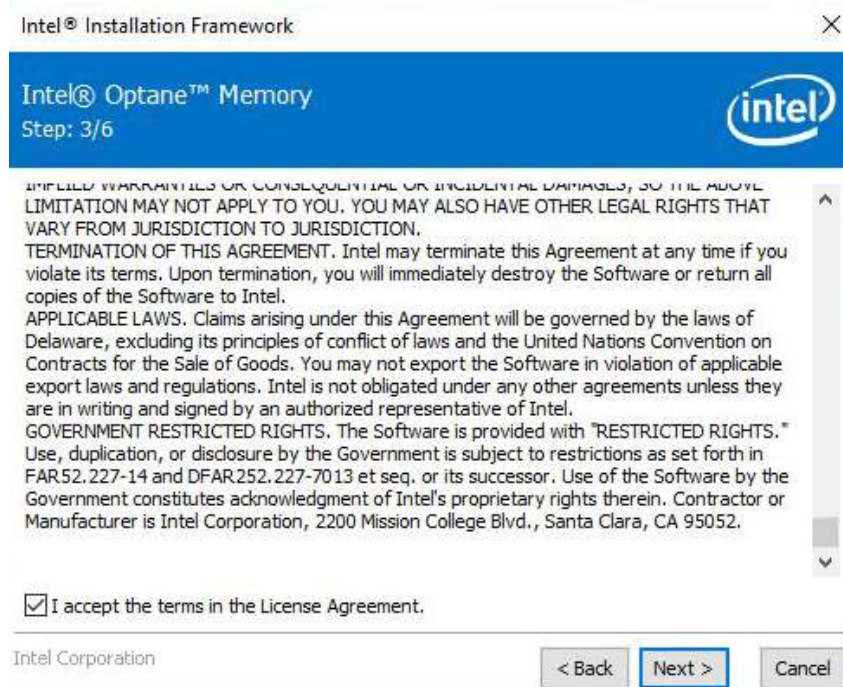

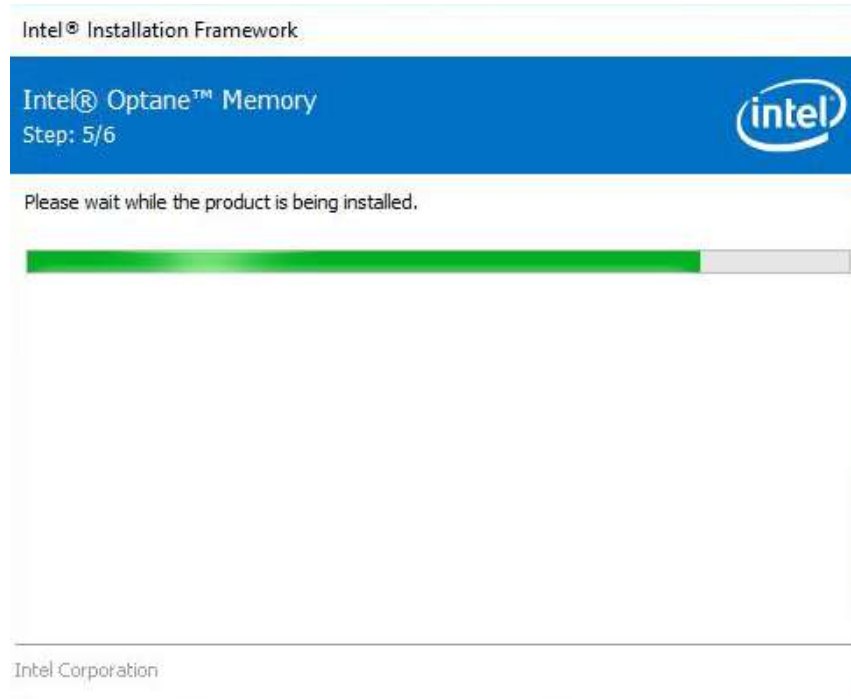

9. When done, click on “Finish” and restart the system.

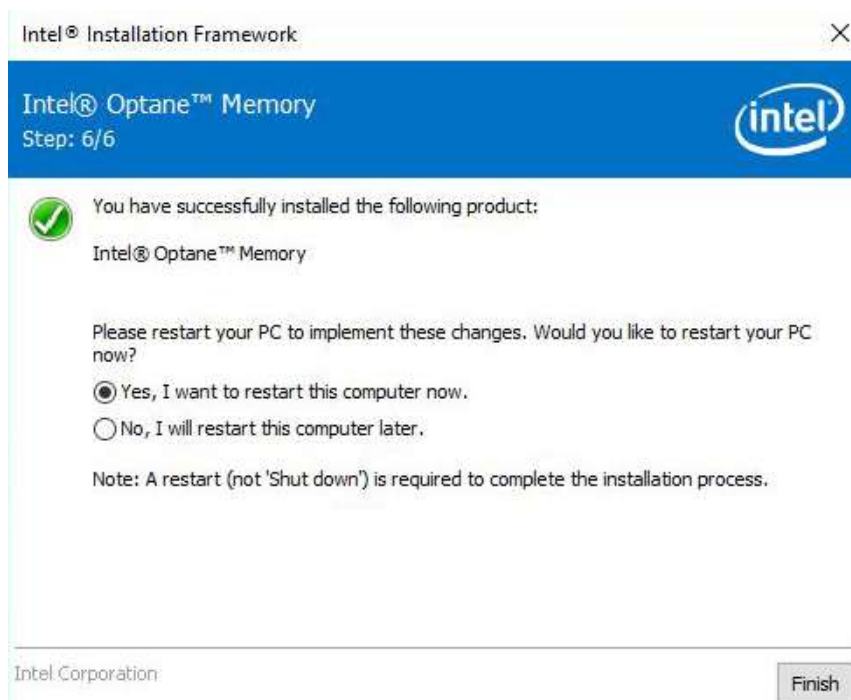

- Upon system restart, the following initialization screen will appear. Click on Next to continue.

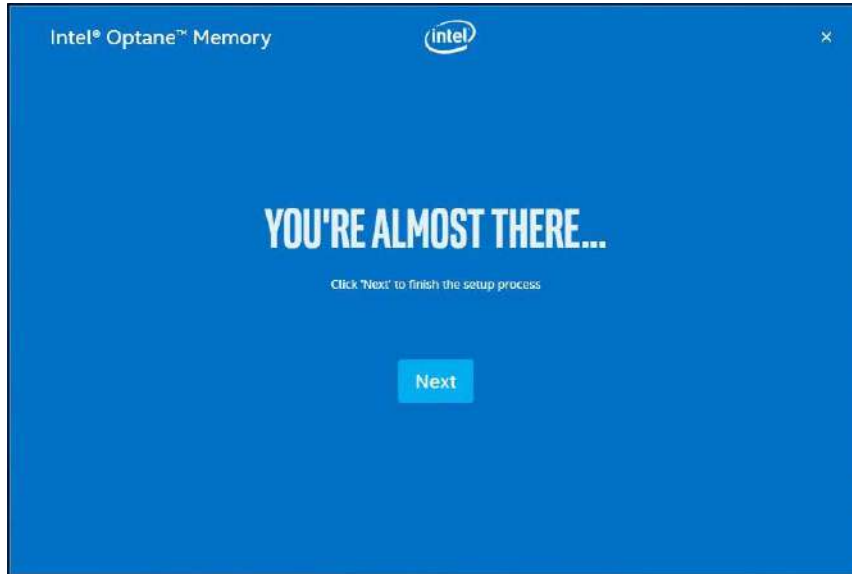

- In the Setup section, you will see your Intel® Optane™ memory drive and compatible drive(s) that can be accelerated. Click on the downward arrow to bring up a selection of drives to be accelerated. Click on “Enable” when ready.

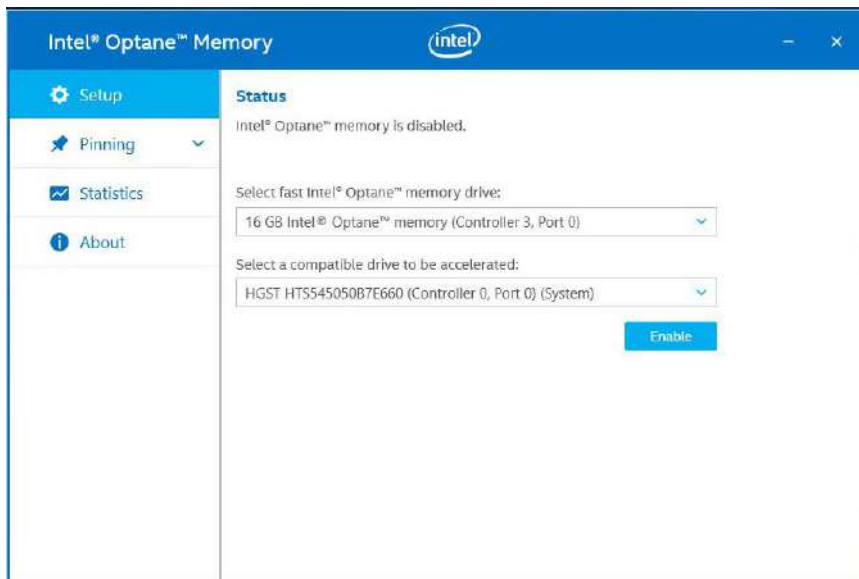

12. The data backup warning will appear, please backup any data you may have stored on your Intel® Optane™ memory module before proceeding. Check the box “Erase all data on Intel® Optane™ memory module” and click on Continue.

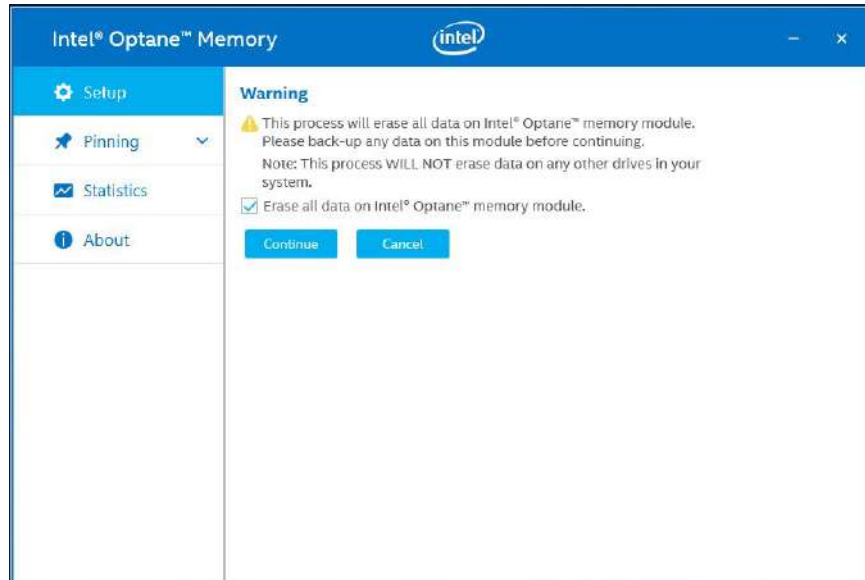

13. When the Intel® Optane™ memory module has been enabled, the installation window and a notification window at the bottom right corner will prompt you to restart the system.

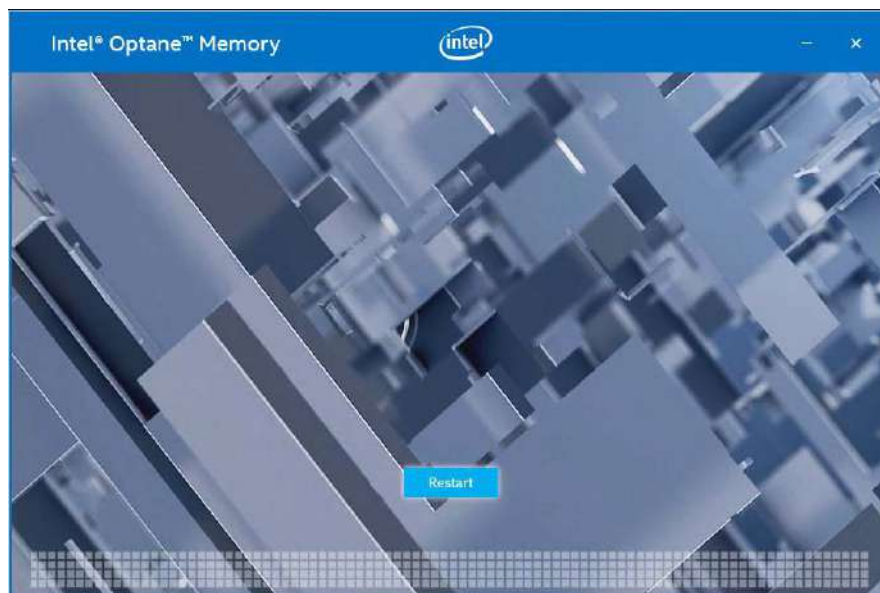

14. Upon system restart, a successful enablement message will appear to indicate the Intel® Optane™ memory module has been enable successfully.

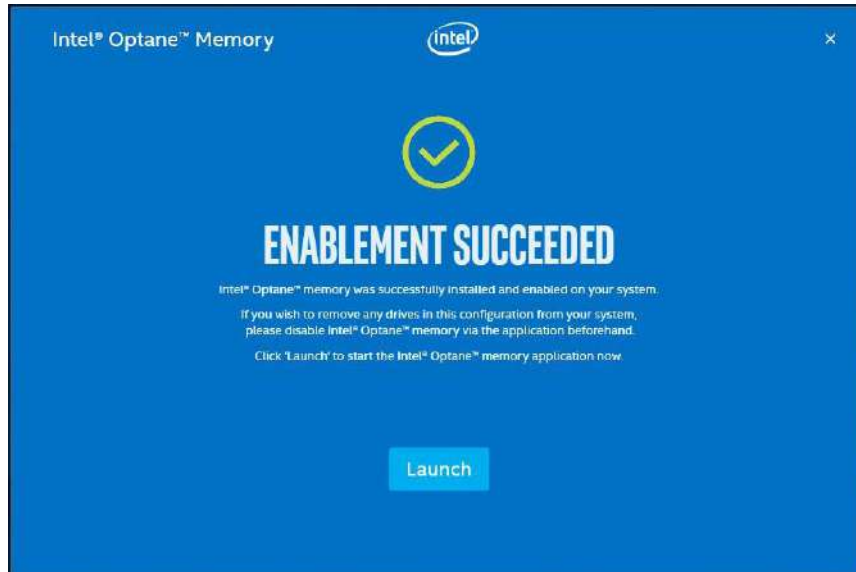

15. Once enabled, the RST software Setup section should show your configuration information.

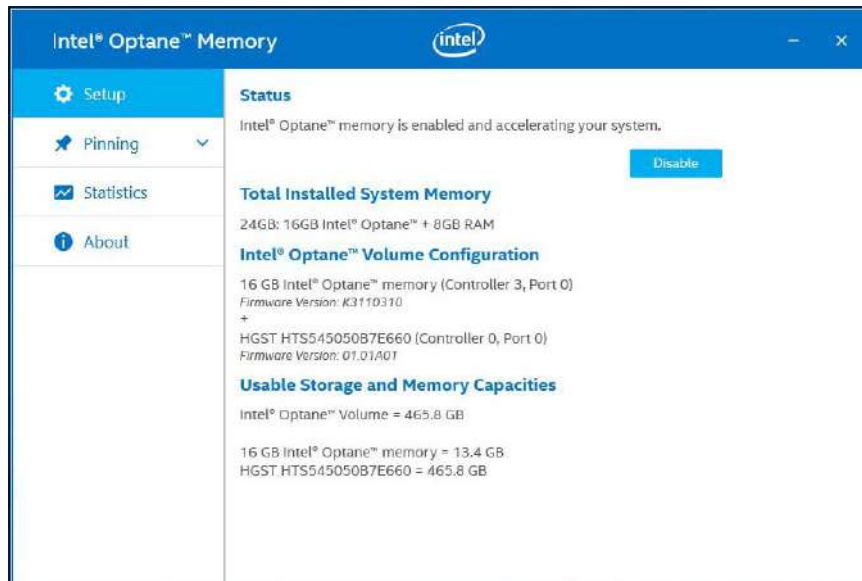

Appendix A Using WDT & DIO

The watchdog timer (WDT) function to ensure reliable system operation. The WDT is a hardware mechanism to reset the system if the watchdog timer is expired. Users can start the WDT and keeping resetting the timer to make sure the system or program is running. Otherwise, the system shall be reset.

In this section, we'll illustrate how to use the function library provided by Neosys to program the WDT functions. Currently, WDT driver library supports Windows 10 x64 and WOW64 platform. For other OS support, please contact Neosys Technology for further information.

Installing WDT_DIO Library

The WDT_DIO function library is delivered in the form of a setup package named **WDT_DIO_Setup.exe**. In prior to program WDT, you should execute the setup program and install the WDT library. Please use the following WDT_DIO_Setup packages according to your operating systems and application.

- For Windows 10 64-bit OS with 64-bit application (x64 mode), please install WDT_DIO_Setup_v2.2.9.x(x64).exe or later version.
- For Windows 10 64-bit OS with 32-bit application (WOW64 mode), please install WDT_DIO_Setup_v2.2.9.x(wow64).exe or later version.

WDT and DIO Library Installation

To setup WDT & DIO Library, please follow instructions below.

1. Execute **WDT_DIO_Setup.2.2.9.x.exe**. and the following dialog appears.

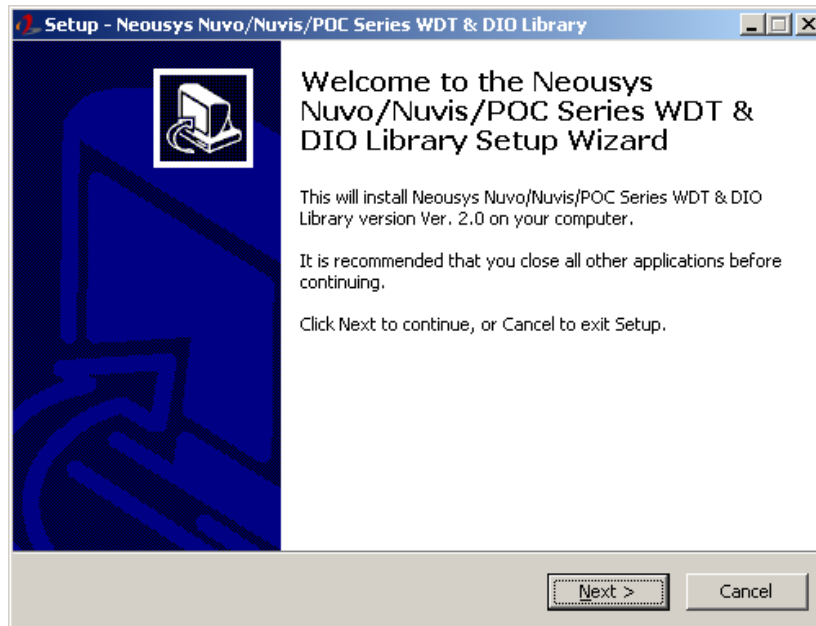

2. Click "Next >" and specify the directory of installing related files. The default directory is **C:\Neosys\WDT_DIO**.

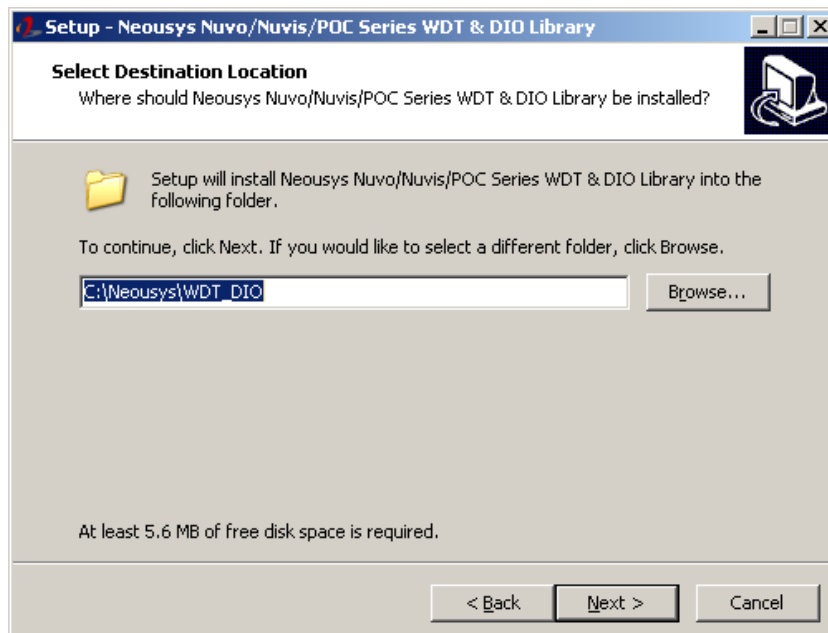

- Once the installation has finished, a dialog will appear to prompt you to reboot the system. The WDT & DIO library will take effect after the system has rebooted.

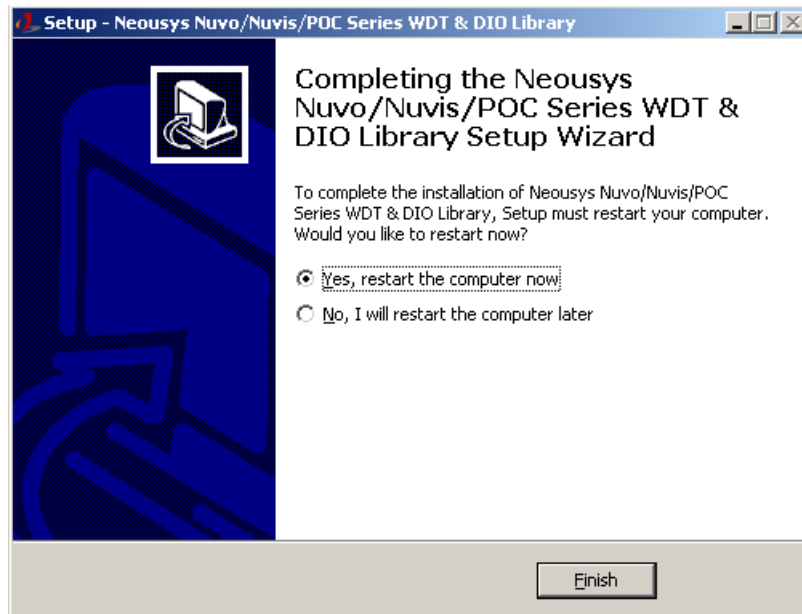

- When programming your WDT or DIO program, the related files are located in

Header File:	\Include
Library File:	\Lib
Function	\Manual
Reference:	
Sample Code:	\Sample\WDT_Demo (Demo for Watchdog Timer)

WDT Functions

InitWDT

Syntax	BOOL InitWDT(void);
Description:	Initialize the WDT function. You should always invoke InitWDT() before set or start watchdog timer.
Parameter	None
Return Value	TRUE: Successfully initialized FALSE: Failed to initialize
Usage	BOOL bRet = InitWDT()

SetWDT

Syntax	BOOL SetWDT(WORD tick, BYTE unit);
Description	Set timeout value and unit for watchdog timer. When InitWDT() is invoked, a default timeout value of 255 seconds is assigned.
Parameter	<i>tick</i> WORD value (1 ~ 65535) to indicate timeout ticks. <i>unit</i> BYTE value (0 or 1) to indicate unit of timeout ticks. 0 : unit is minute 1 : unit is second
Return Value	If value of unit is correct (0 or 1), this function returns TRUE, otherwise FALSE.
Usage	WORD tick=255; BYTE unit=1; //unit is second. BOOL bRet = SetWDT(tick, unit); //timeout value is 255 seconds

StartWDT

Syntax	BOOL StartWDT(void);
Description	Starts WDT countdown. Once started, the WDT LED indicator will begin blinking. If ResetWDT() or StopWDT is not invoked before WDT countdowns to 0, the WDT expires and the system resets.
Parameter	None
Return Value	If the timeout value is given in correct format (WDT started), this function returns TRUE, otherwise FALSE
Usage	BOOL bRet = StartWDT()

ResetWDT

Syntax	BOOL ResetWDT(void);
Description	Reset the timeout value to the value given by SetWDT().If ResetWDT() or StopWDT is not invoked before WDT countdowns to 0, the WDT expires and the system resets.
Parameter	None
Return Value	Always returns TRUE
Usage	BOOL bRet = ResetWDT()

StopWDT

Syntax	BOOL StopWDT(void);
Description	Stops the countdown of WDT. When WDT has stopped, the WDT LED indicator stops blinking.
Parameter	None
Return Value	Always returns TRUE
Usage	BOOL bRet = StopWDT()

Using DIO Function

Wiring for DIO

The digital input function of System series is implemented using a photo-coupler with an internally series-connected 1kΩ resistor. You need to provide a voltage to specify the logic high/low state. The input voltage for logic high is 5~24V, and the input voltage for logic low is 0~1.5V.

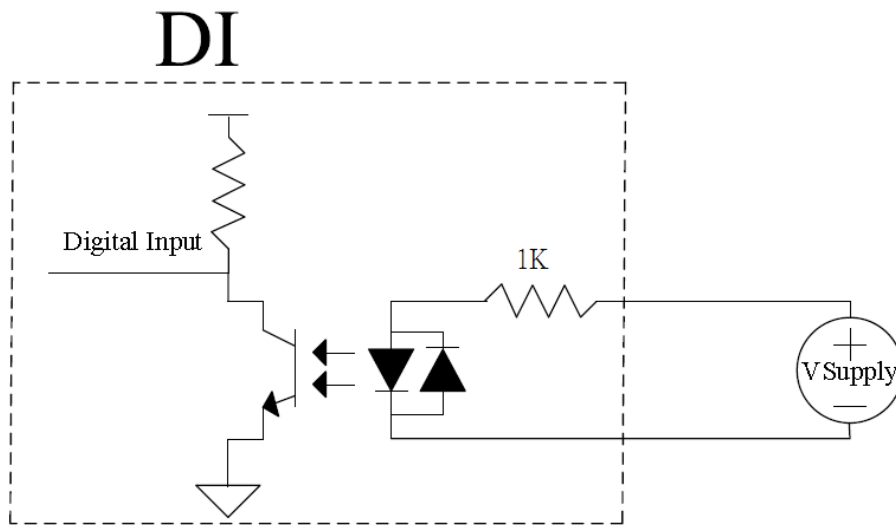

The digital output function of System series is implemented using Power MOSFET + Analog Device iCoupler® component. The DO channels are configured as NO (normally-open) configuration. When you turn on system, all DO channels have a deterministic state of logic 0 (circuit disconnected from GND return). When logic 1 is specified, MOSFET is activated and GND return path is established. The digital output function on System series supports sinking current connection. The following diagrams are the suggested wiring for DO:

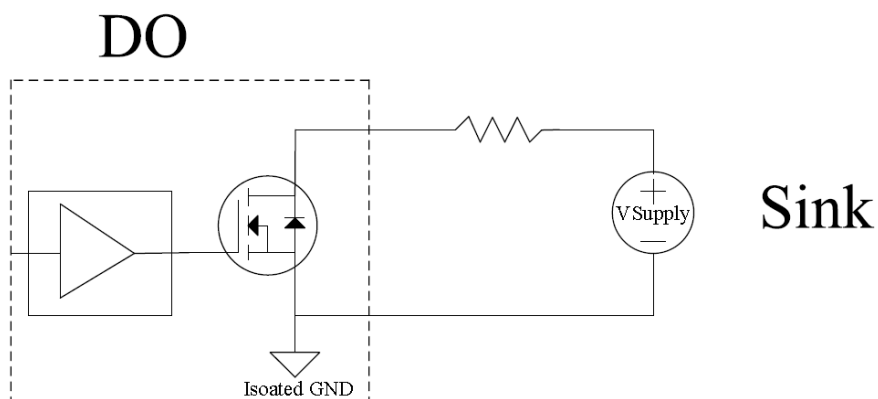

DIO Pin Definition

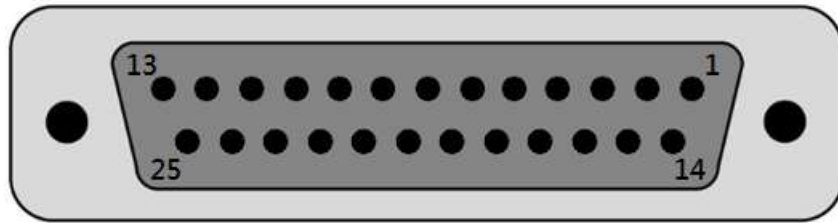

Pin No.	Definition	I/O	Description
1	ISO_DI3H	I	Digital input channel 3
2	ISO_DI2H	I	Digital input channel 2
3	ISO_DI1H	I	Digital input channel 1
4	ISO_DI0H	I	Digital input channel 0
5	Reserved	-	Reserved pin. Keep unconnected
6	Reserved	-	Reserved pin. Keep unconnected
7	ISO_DO3	O	Digital output channel 3
8	ISO_DO2	O	Digital output channel 2
9	ISO_DO1	O	Digital output channel 1
10	ISO_DO0	O	Digital output channel 0
11	VDD	-	DO voltage source input for inductive load
12	Reserved	-	Reserved pin. Keep unconnected
13	Reserved	-	Reserved pin. Keep unconnected
14	ISO_DI3L	-	Digital input channel 3 GND
15	ISO_DI2L	-	Digital input channel 2 GND
16	ISO_DI1L	-	Digital input channel 1 GND
17	ISO_DI0L	-	Digital input channel 0 GND
18	Reserved	-	Reserved pin. Keep unconnected
19	Reserved	-	Reserved pin. Keep unconnected
20	DOGND	-	Digital output GND
21	DOGND	-	Digital output GND
22	DOGND	-	Digital output GND
23	DOGND	-	Digital output GND
24	DOGND	-	Digital output GND
25	DOGND	-	Digital output GND

DIO Function Reference

InitDIO

Syntax	BOOL InitDIO(void);
Description:	Initialize the DIO function. You should always invoke InitDIO() before write/read any DIO port/channel.
Parameter	None
Return Value	TRUE: Successfully initialized FALSE: Failed to initialize
Usage	BOOL bRet = InitWDT();

DIReadLine

Syntax	BOOL DIReadLine(BYTE ch);
Description:	Read a single channel of isolated digital input.
Parameter	<i>ch</i> BYTE value specifies the DI channel to be read. <i>ch</i> should be a value of 0 ~ 3.
Return Value	The status (TRUE or FALSE) of the specified DI channel.
Usage	BYTE ch=3; //DI channel #3 BOOL DIChValue = DIReadLine(ch); //read DI channel #3

DIReadPort

Syntax	WORD DIReadPort(void);
Description:	Read the entire isolated digital input port (4 channels).
Parameter	None
Return Value	The status (TRUE or FALSE) of the specified DI channel.
Usage	WORD DIPortValue = DIReadPort ();

DOWriteLine

Syntax	void DOWriteLine(BYTE ch, BOOL value);
Description:	Write a single channel of isolated digital output.
Parameter	<p><i>ch</i> BYTE value specifies the DO channel to be written. <i>ch</i> should be a value of 0 ~ 3.</p> <p><i>value</i> BOOL value (TRUE or FALSE) specifies the status of DO channel.</p>
Return Value	None
Usage	<pre> BYTE ch=3; //DI channel #3 BOOL DOChValue=TRUE; DOWriteLine(ch, DOChValue); //write DO channel #3 as TRUE </pre>

DOWritePort

Syntax	void DOWritePort(WORD value);
Description:	Write the entire isolated digital output port (4 channels).
Parameter	<p><i>value</i> WORD value specifies the status of the DO port. <i>value</i> should be a value of 0~15.</p>
Return Value	None
Usage	<pre> WORD DOPortValue=0x0C; //1100b DOWritePort(DOPortValue); //write DO port as 1100b </pre>

DOWriteLineChecked

Syntax	void DOWriteLineChecked(BYTE ch, BOOL value);
Description:	Write a single channel of isolated digital output and read-back the value of DO register. Note that this function is not returned until the DO register is checked and identical to the written value.
Parameter	<p><i>ch</i> BYTE value specifies the DO channel to be written. <i>ch</i> should be a value of 0 ~ 3.</p> <p><i>value</i> BOOL value (TRUE or FALSE) specifies the status of DO channel.</p>
Return Value	None
Usage	<pre> BYTE ch=3; //DI channel #3 BOOL DOChValue=TRUE; DOWriteLineChecked(ch, DOChValue); //write DO channel #3 as TRUE </pre>

DOWritePortChecked

Syntax	void DOWritePortChecked(WORD value);
Description:	Write the entire isolated digital output port (8 channels) and check it has been done. Note that this function is not returned until the write value has been checked the same with the device registry.
Parameter	<p><i>value</i> WORD value specifies the status of the DO port. <i>value</i> should be a value of 0~15.</p>
Return Value	None
Usage	<pre> WORD DOPortValue=0x0C; //1100b DOWritePortChecked(DOPortValue); //write DO port as 1100b </pre>

COS Function Reference

SetupDICOS

Syntax	<pre>BOOL SetupDICOS(COS_INT_SETUP *lpSetup, DWORD cbSetup);</pre>
Description	Setup Digital-Input(DI) Change-of-State(COS) interrupt parameters.
Parameter	<p><i>lpSetup</i> [in] A pointer to a COS_INT_SETUP structure that contains the COS configuration information for the DI device. This data structure contains the following variables:</p> <p><i>portMask</i> WORD value specifies the interrupt mask for corresponding channel(s).</p> <p><i>edgeMode</i> WORD value specifies that interrupt is generated when level change (set to 0) or on rising/falling edge (set to 1) for the corresponding channel(s).</p> <p><i>edgeType</i> WORD value specifies that interrupt is generated on rising edge (set to 0) or falling (set to 1) edge for corresponding channel(s). This value is neglected if <i>edgeMode</i> is set to 0 for the corresponding channel(s).</p> <p><i>cbSetup</i> [in] The length of the structure, in bytes. The caller must set this member to size of (COS_INT_SETUP).</p>
Return Value	<p>TRUE if setup successes FALSE if setup failed</p>
Usage	<pre>COS_INT_SETUP setup; memset(&setup, 0, sizeof(setup)); setup.portMask = 0x0f; // enable ch.0~3 setup.edgeMode = 0; // level setup.edgeType = 0x00; // Lo/Hi BOOL bRet = SetupDICOS(&setup, sizeof(setup));</pre>

RegisterCallbackDICOS

Syntax	BOOL RegisterCallbackDICOS(COS_INT_CALLBACK callback);
Description:	Registers a callback function, which is called when the DICOS interrupt occurred.
Parameter	<p>callback [in]</p> <p>Specifies the callback function. The prototype for this function is described as follow.</p> <pre>void __stdcall callback_func(COS_INT_CALLBACK_ARG* arg);</pre>
Return Value	<p>TRUE if setup successes,</p> <p>FALSE if setup failed.</p>
Usage	<pre>void __stdcall callback_func(COS_INT_CALLBACK_ARG* arg) { printf("data=0x%02x, flag=0x%02x, seq=%02d\n", arg->portData, arg->intrFlag, arg->intrSeq); } BOOL bRet = RegisterCallbackDICOS(callback_func);</pre>

StartDICOS

Syntax	BOOL StartDICOS(void);
Description	Start DI Change-of-State interrupt
Parameter	None
Return Value	<p>TRUE if start procedure successes</p> <p>FALSE if start procedure failed</p>
Usage	BOOL bRet = StartDICOS();

StopDICOS

Syntax	BOOL StopDICOS(void);
Description	Stop DI Change-of-State interrupt
Parameter	None
Return Value	TRUE if stop procedure successes FALSE if stop procedure failed
Usage	BOOL bRet = StopDICOS();

DI COS Example

```

#include <stdio.h>
#include <stdlib.h>
#include <windows.h>
#include "WDT_DIO.h"

//Step 0, define a Change-of-State Interrupt callback function
void __stdcall callback_function(COS_INT_CALLBACK_ARG* arg)
{
    printf("data=0x%02x, flag=0x%02x, seq=%02d\n",
        arg->portData, arg->intrFlag, arg->intrSeq);
}

int main(int argc, char* argv[])
{
    //Step 1, initialize DIO library by invoking InitDIO()
    if ( ! InitDIO() )
    {
        printf("InitDIO --> FAILED\n");
        return -1;
    }
    printf("InitDIO --> PASSED\n");

    //Step 2, setup Change-of-State Interrupt mask and level/edge mode
    COS_INT_SETUP setup;

```

```
memset(&setup, 0, sizeof(setup));

setup.portMask = 0x0f;      // 00001111b, enable ch.0~3
setup.edgeMode = 0x00;     // generate interrupt on level change
setup.edgeType = 0x00;     // rising/falling edge, only effective when edgeMode = 1

if ( ! SetupDICOS(&setup, sizeof(setup)) )
{
    printf("SetupDICOS --> FAILED\n");
    return -2;
}
printf("SetupDICOS --> PASSED\n");
```

//Step 3, register the callback function

```
if ( ! RegisterCallbackDICOS(callback_function) )
{
    printf("RegisterCallbackDICOS --> FAILED\n");
    return -3;
}
printf("RegisterCallbackDICOS --> PASSED\n");
```

//Step 4, start the DI Change-of-State Interrupt

```
if ( ! StartDICOS() )
{
    printf("StartDICOS --> FAILED\n");
    return -4;
}
printf("StartDICOS --> PASSED\n");
```

```
printf("\npress any key to stop...\n");
system("pause >nul");
```

//Step 5, stop the DI Change-of-State Interrupt operation

```
if ( ! StopDICOS() )
{
    printf("StopDICOS --> FAILED\n");
    return -5;
}
```

```
printf("StopDICOS --> PASSED\n");

printf("\npress any key to exit...\n");
system("pause >nul");
return 0;

}
```

Appendix B PoE On/ Off Control

Nuvo-7000series offer 802.3at PoE+ ports and users are allowed to manually turn on or off the power supply of each PoE port. This can be useful in power device (PD) fault-recovery or power reset. The APIs are part of Neousys WDT_DIO driver package. Please follow the instructions in [Appendix A Watchdog Timer & Isolated DIO](#) for installation before programming PoE on/off control function.

GetStatusPoEPort

Syntax	BYTE GetStatusPoEPort (Byte port);
Description	Get current on/off status of designated PoE port.
Parameter	<i>port</i> BYTE value specifies the index of PoE port. Please refer to the following illustration, <i>port</i> should be a value of 1 ~ 8
Return Value	BYTE value indicating PoE on/off status 0 if port is disabled (off) 1 if port is enabled (on)
Usage	BYTE bEnabled = GetStatusPoEPort (1); //Get on/off status of PoE Port#1

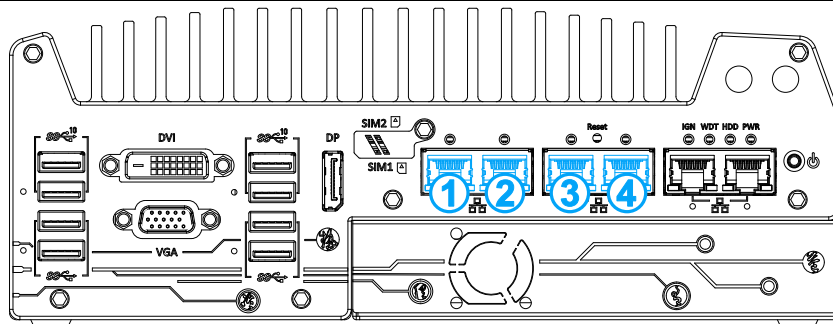

PoE+ ports on the front panel of Nuvo-7108/ 7208/ 7258VTC.

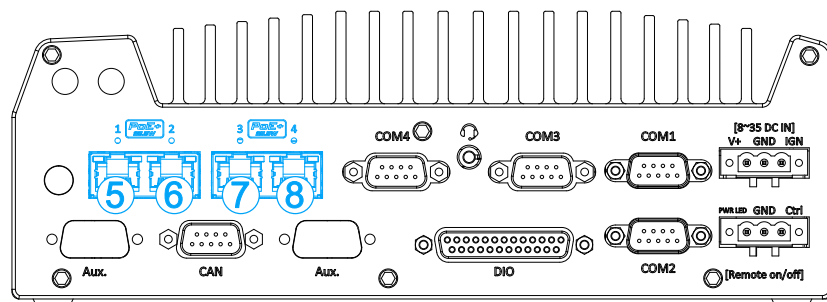

PoE+ port location on the rear panel of Nuvo-7000VTC series

EnablePoEPort

Syntax	BOOL EnablePoEPort (BYTE port);
Description	Turn on PoE power of designated PoE port.
Parameter	<i>port</i> BYTE value specifies the index of PoE port. Please refer to the following illustration, <i>port</i> should be a value of 1 ~ 8
Return Value	TRUE if enabled success FALSE if fail to enable.
Usage	BOOL bRet = EnablePoEPort (1); //Turn on PoE Port#1

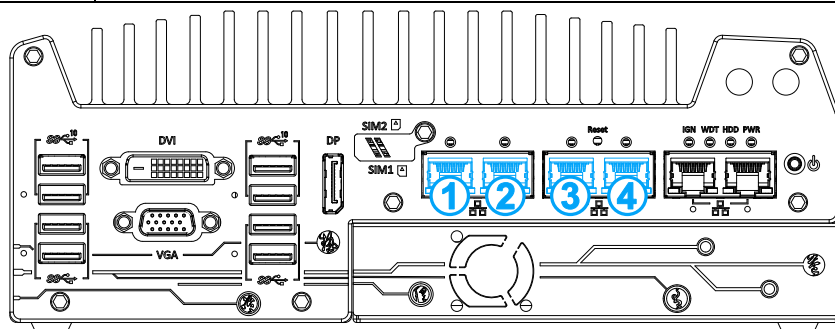

PoE+ ports on the front panel of Nuvo-7108/ 7208/ 7258VTC.

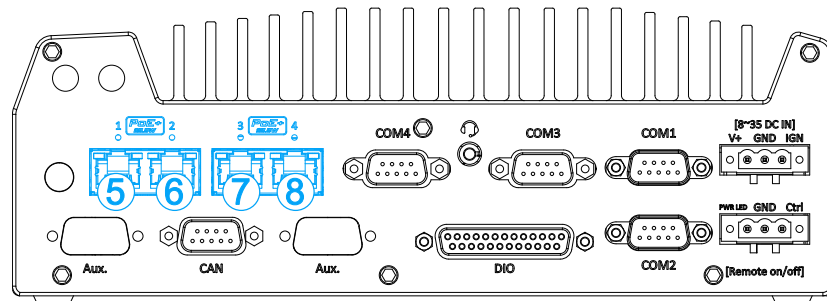

PoE+ port location on the rear panel of Nuvo-7000VTC series

DisablePoEPort

Syntax	BOOL DisablePoEPort (BYTE port);
Description	Turn off PoE power of designated PoE port
Parameter	<i>port</i> BYTE value specifies the index of PoE port. Please refer to the following illustration, <i>port</i> should be a value of 1 ~ 8
Return Value	TRUE if disabled success FALSE if fail to disable
Usage	BOOL bRet = DisablePoEPort (1); //Turn off PoE Port#1

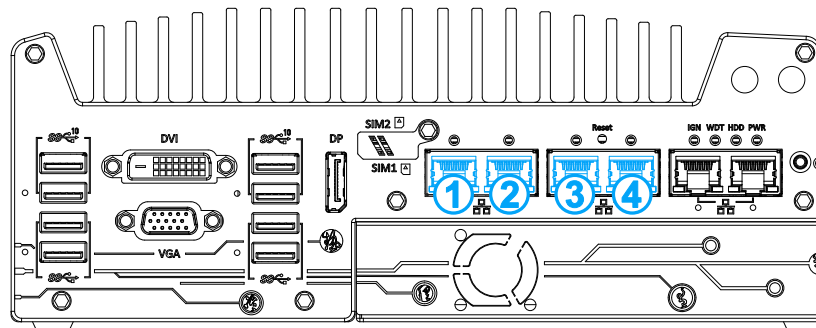

PoE+ ports on the front panel

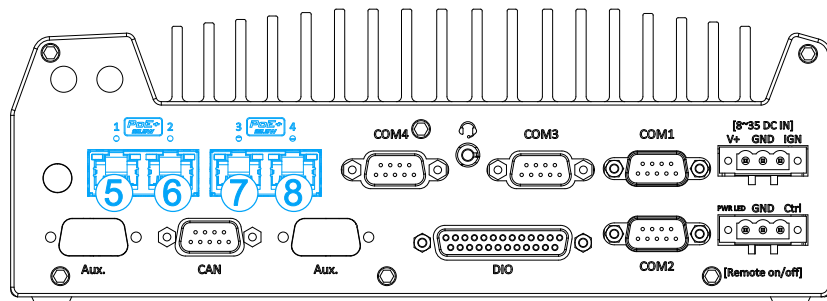

PoE+ ports location on the rear panel of Nuvo-7100/ 7200/ 7250/ 7104/ 7204/ 7254VTC