

Neosys Technology Inc.

POC-500 Series

User Manual

Revision 1.1

Table of Contents

Table of Contents	2
Legal Information	5
Contact Information	6
Declaration of Conformity	6
Copyright Notice	7
Safety Precautions	8
Service and Maintenance	9
ESD Precautions	9
About This Manual	10
1 Introduction	
1.1 Specification of POC-515	12
1.2 Specification of POC-516	14
1.3 Specification of POC-545	16
1.4 Specification of POC-546	18
1.5 Dimension of POC-515/ POC-516	20
1.5.1 Front Panel View	20
1.5.2 DIO Panel View	21
1.5.3 COM and Audio Port Panel View	21
1.5.4 Bottom View	22
1.6 Dimension of POC-545/ POC-546	23
1.6.1 Front Panel View	23
1.6.2 DIO Panel View	24
1.6.3 COM and Audio Port Panel View	24
1.6.4 Bottom View	25
2 System Overview	
2.1 Unpacking the System	26
2.2 POC-500 Series Front Panel	27
2.2.1 3-pin Terminal Block for DC Input (Optional Ignition Input)	28
2.2.2 3-pin Remote On/ Off	29
2.2.3 IEEE 802.3at Power over Ethernet Port	30
2.2.4 USB 3.1 Gen1	31
2.2.5 System Status LED	31
2.2.6 DisplayPort	32
2.2.7 VGA Port	33
2.3 COM Port Panel	34
2.3.1 Power Button	35
2.3.2 COM 1 Port	36
2.3.3 COM Port (COM2/ COM3/ COM4)	37
2.3.4 4-Pole 3.5mm Microphone-in/ Speaker-out Jack	38
2.3.5 SMA Antenna Opening	39
2.4 CMOS Reset Button	40
2.5 Reserved Port Opening Panel	41
2.6 Internal I/O	42
2.6.1 Full-size mini-PCIe Slot and SIM Socket	42
2.6.2 M.2 2280 (M Key) Slot for NVMe SSD	44
2.6.3 SO-DIMM Socket	46
2.7 MeziO™ Interface	47
2.7.1 MeziO™ Interface Pin Definition	48
2.7.2 MeziO™ Modules for POC-500 Series	49
3 System Installation	
3.1 Disassembling the System Enclosure	51
3.2 Installing Internal Components	55

3.2.1	DDR4 SO-DIMM Installation	55
3.2.2	mini-PCIe Module, SIM Card and Antenna Installation	56
3.2.3	M.2 2880 M Key NVMe SSD Installation	60
3.2.4	MezIO™ Module Installation	62
3.3	Installing the System Enclosure	64
3.4	DIN Rail Installation.....	67
3.5	Wall Mount Installation (Optional).....	70
3.5.1	Vertical Wall Mount Bracket (Optional).....	71
3.6	Powering On the System	72
3.6.1	Powering On Using the Power Button.....	72
3.6.2	Powering On Using An External Non-Latched Switch.....	73
3.6.3	Powering On Using Wake-on-LAN.....	74

4 BIOS Settings

4.1	COM1/ 2 Port Configuration	78
4.2	COM 3/ 4 Port Configuration	79
4.3	COM Port High Speed Mode.....	80
4.4	SATA Configuration for MezIO™ Module.....	81
4.5	TPM Availability	82
4.6	System Power Configuration (POC-515/ 516)	83
4.7	System Power Configuration (POC-545/ 546)	84
4.8	Power over Ethernet (PoE)	85
4.9	Wake-on-LAN	86
4.10	Power On after Power Failure	87
4.11	Boot Menu.....	88
4.12	Boot Type (Legacy/ UEFI).....	90
4.13	Position New Boot Device.....	91
4.14	Watchdog Timer	92

5 OS Support and Driver Installation

5.1	Operating System Compatibility	93
5.2	Driver Installation	94
5.2.1	Install Drivers Automatically	94
5.2.2	Install Drivers Manually.....	95
5.3	Driver for Watchdog Timer and DIO.....	96

Appendix A Using WDT & DIO

WDT and DIO Library Installation	98
WDT Function Reference	100
InitWDT	100
SetWDT	100
StartWDT	101
ResetWDT	101
StopWDT	101
Using DIO Function (POC516/ POC-546 Only).....	102
Wiring for DIO	102
DIO Pin Definition.....	103
DIO Function Reference	104
InitDIO.....	104
DIReadLine	104
DIReadPort	104
DOWriteLine.....	105
DOWritePort.....	105
DOWriteLineChecked	106
DOWritePortChecked.....	106
COS Function Reference	107
SetupDICOS	107
RegisterCallbackDICOS.....	108
StartDICOS	108
StopDICOS	108

DI COS Example..... 109

Appendix B PoE On/ Off Control

PoE On/ Off Control Function Reference..... 111
GetStatusPoEPort..... 111
EnablePoEPort..... 112
DisablePoEPort..... 113

Legal Information

All Neosys Technology Inc. products shall be subject to the latest Standard Warranty Policy

Neosys Technology Inc. may modify, update or upgrade the software, firmware or any accompanying user documentation without any prior notice. Neosys Technology Inc. will provide access to these new software, firmware or documentation releases from download sections of our website or through our service partners.

Before installing any software, applications or components provided by a third party, customer should ensure that they are compatible and interoperable with Neosys Technology Inc. product by checking in advance with Neosys Technology Inc.. Customer is solely responsible for ensuring the compatibility and interoperability of the third party's products. Customer is further solely responsible for ensuring its systems, software, and data are adequately backed up as a precaution against possible failures, alternation, or loss.

For questions in regards to hardware/ software compatibility, customers should contact Neosys Technology Inc. sales representative or technical support.

To the extent permitted by applicable laws, Neosys Technology Inc. shall NOT be responsible for any interoperability or compatibility issues that may arise when (1) products, software, or options not certified and supported; (2) configurations not certified and supported are used; (3) parts intended for one system is installed in another system of different make or model.

Contact Information

Headquarters
(Taipei, Taiwan) **Neosys Technology Inc.**
15F, No.868-3, Zhongzheng Rd., Zhonghe Dist., New Taipei City, 23586, Taiwan
Tel: +886-2-2223-6182 Fax: +886-2-2223-6183 [Email](#), [Website](#)

Americas
(Illinois, USA) **Neosys Technology America Inc.**
3384 Commercial Avenue, Northbrook, IL 60062, USA
Tel: +1-847-656-3298 [Email](#), [Website](#)

China **Neosys Technology China Co., Ltd.**
Room 612, Building 32, Guiping Road 680, Shanghai
Tel: +86-2161155366 [Email](#), [Website](#)

Declaration of Conformity

FCC This equipment has been tested and found to comply with the limits for a Class A digital device, pursuant to part 15 of the FCC Rules. These limits are designed to provide reasonable protection against harmful interference when the equipment is operated in a commercial environment. This equipment generates, uses, and can radiate radio frequency energy and, if not installed and used in accordance with the instruction manual, may cause harmful interference to radio communications. Operation of this equipment in a residential area is likely to cause harmful interference in which case the user will be required to correct the interference at own expense.

CE The product(s) described in this manual complies with all applicable European Union (CE) directives if it has a CE marking. For computer systems to remain CE compliant, only CE-compliant parts may be used. Maintaining CE compliance also requires proper cable and cabling techniques.

Copyright Notice

All rights reserved. This publication may not be reproduced, transmitted, transcribed, stored in a retrieval system, or translated into any language or computer language, in any form or by any means, electronic, mechanical, magnetic, optical, chemical, manual or otherwise, without the prior written consent of Neosys Technology, Inc.

Disclaimer

This manual is intended to be used as an informative guide only and is subject to change without prior notice. It does not represent commitment from Neosys Technology Inc. Neosys Technology Inc. shall not be liable for any direct, indirect, special, incidental, or consequential damages arising from the use of the product or documentation, nor for any infringement on third party rights.

Patents and Trademarks

Neosys, the Neosys logo, Expansion Cassette, MezIO™ are registered patents and trademarks of Neosys Technology, Inc.

Windows is a registered trademark of Microsoft Corporation.

AMD, Ryzen™ are registered trademarks of Advanced Micro Devices, Inc

All other names, brands, products or services are trademarks or registered trademarks of their respective owners.

Safety Precautions

- Read these instructions carefully before you install, operate, or transport the system.
- Install the system or DIN rail associated with, at a sturdy location
- Install the power socket outlet near the system where it is easily accessible
- Secure each system module(s) using its retaining screws
- Place power cords and other connection cables away from foot traffic. Do not place items over power cords and make sure they do not rest against data cables
- Shutdown, disconnect all cables from the system and ground yourself before touching internal modules
- Ensure that the correct power range is being used before powering the device
- Should a module fail, arrange for a replacement as soon as possible to minimize down-time
- If the system is not going to be used for a long time, disconnect it from mains (power socket) to avoid transient over-voltage

Service and Maintenance

- ONLY qualified personnel should service the system
- Shutdown the system, disconnect the power cord and all other connections before servicing the system
- When replacing/ installing additional components (expansion card, memory module, etc.), insert them as gently as possible while assuring proper connector engagement

ESD Precautions

- Handle add-on module, motherboard by their retention screws or the module's frame/ heat sink. Avoid touching the PCB circuit board or add-on module connector pins
- Use a grounded wrist strap and an anti-static work pad to discharge static electricity when installing or maintaining the system
- Avoid dust, debris, carpets, plastic, vinyl and Styrofoam in your work area.
- Do not remove any module or component from its anti-static bag before installation

About This Manual

This manual introduces and demonstrates installation procedures of Neosys POC-500 series systems featuring AMD Ryzen™ Embedded V1000 4-core/ 8-thread processor. The manual also demonstrates the system's general installation procedures.

Revision History

Version	Date	Description
1.0	Oct. 2019	Initial release
1.1	Jul. 2023	Updated CMOS reset button descriptions

1 Introduction

POC-500 series is an ultra-compact embedded controller offering performances never-seen-before in this form factor. Featuring AMD Ryzen™ Embedded V1000 4-core/ 8-thread processor, it delivers up to 3x times the CPU performance over previous POC series. GPU performance wise, it delivers an unheard of 3.6 TFLOPS in FP16 for an ultra-compact form factor embedded controller. Another amazing feat is that it manages to incorporate an M.2 2280 NVMe SSD to support 2x times the disk read/ write speed over typical 2.5" SATA SSDs.



POC-515/ 516



POC-545/ 546

POC-500 series continues the POC series ingenious mechanical design that can be DIN-rail mounted and offers plenty of front-accessible I/Os. Measuring just 64.36 x 175.8 x 115.5 mm (2.5" x 6.9" x 4.6"), it has 4x PoE+ ports, 4x USB 3.1 Gen1 ports and 4x COM ports. And best of all, all data ports come with screw-lock mechanisms so you can be rest assured that cables are always secured. POC-500 series is available in two CPU variants, the V1807B (45W) variant is for high computing power demand and the V1605B (15W) variant is designed for rugged fanless operation.

1.1 Specification of POC-515

System Core	
Processor	AMD Ryzen™ V1605B CPU (4C/ 8T, 2M Cache, 2.0/ 3.6 GHz)
Graphics	Vega GPU with 8 compute units
Memory	Up to 16 GB DDR4-2400 SDRAM (one SODIMM socket)
Panel I/O Interface	
PoE+	4x IEEE 802.3at Gigabit PoE+ ports by Intel® I350-AM4 with screw-lock
USB	4x USB 3.1 Gen1 ports with screw-lock
Video port	1x VGA connector, supporting 1920 x 1200 resolution 1x DisplayPort connector, supporting 4096 x 2160 resolution
Serial port	1x software-programmable RS-232/ 422/ 485 port (COM1) 3x 3-wire RS-232 ports (COM2/ 3/ 4) or 1x RS-422/ 485 port (COM2)
Audio	1x 3.5mm jack for mic-in and speaker-out
Internal I/O Interface	
Mini PCI-E	1x full-size mini PCI Express socket with internal SIM socket
Expandable I/O	1x MeziO™ expansion interface for Neosys MeziO™ modules
Storage Interface	
M.2 NVMe	1x M.2 2280 M key NVMe socket (PCIe Gen3 x2) for NVMe SSD installation
Power Supply	
DC input	1x 3-pin pluggable terminal block for 8~35VDC DC input
Remote Ctrl.& LED output	1x3-pin pluggable terminal block for remote control and PWR LED output
Mechanical	
Dimension	64.4 mm (W) x 115.5 mm (D) x 175.8 mm (H)
Weight	1.2kg
Mounting	DIN-rail mount (standard) or wall-mount (optional)
Environmental	
Operating temperature	-25°C ~ 70°C *
Storage temperature	-40°C ~85°C
Humidity	10%~90% , non-condensing

Vibration	Operating, MIL-STD-810G, Method 514.6, Category 4
Shock	Operating, MIL-STD-810G, Method 516.6, Procedure I, Table 516.6-II)
EMC	CE/ FCC Class A, according to EN 55032 & EN 55024

** For sub-zero and over 60°C operating temperature, a wide temperature HDD or Solid State Disk (SSD) is required.*

1.2 Specification of POC-516

System Core	
Processor	AMD Ryzen™ V1605B CPU (4C/ 8T, 2M Cache, 2.0/ 3.6 GHz)
Graphics	Vega GPU with 8 compute units
Memory	Up to 16 GB DDR4-2400 SDRAM (one SODIMM socket)
Panel I/O Interface	
Isolated digital output	4-CH isolated digital output
Isolated digital input	4-CH isolated digital input
Ethernet	4x IEEE 802.3at Gigabit PoE+ ports by Intel® I350-AM4 with screw-lock
USB	4x USB 3.1 Gen1 ports with screw-lock
Video port	1x VGA connector, supporting 1920 x 1200 resolution 1x DisplayPort connector, supporting 4096 x 2160 resolution
Serial port	1x software-programmable RS-232/ 422/ 485 port (COM1) 3x 3-wire RS-232 ports (COM2/ 3/ 4) or 1x RS-422/ 485 port (COM2)
Audio	1x 3.5mm jack for mic-in and speaker-out
Internal I/O Interface	
Mini PCI-E	1x full-size mini PCI Express socket with internal SIM socket
Storage Interface	
M.2 NVMe	1x M.2 2280 M key NVMe socket (PCIe Gen3 x2)
SATA	1x SATA interface for 2.5" SSD/ HDD
Power Supply	
DC input	1x 3-pin pluggable terminal block for 8~35VDC DC input
Remote Ctrl.& LED output	1x3-pin pluggable terminal block for remote control and PWR LED output
Mechanical	
Dimension	64.4 mm (W) x 115.5 mm (D) x 175.8 mm (H)
Weight	1.2kg
Mounting	DIN-rail mount (standard) or wall-mount (optional)
Environmental	
Operating temperature	-25°C ~ 70°C *

Storage temperature	-40°C ~85°C
Humidity	10%~90% , non-condensing
Vibration	Operating, MIL-STD-810G, Method 514.6, Category 4
Shock	Operating, MIL-STD-810G, Method 516.6, Procedure I, Table 516.6-II)
EMC	CE/ FCC Class A, according to EN 55032 & EN 55024

** For sub-zero and over 60°C operating temperature, a wide temperature HDD or Solid State Disk (SSD) is required.*

1.3 Specification of POC-545

System Core	
Processor	AMD Ryzen™ V1807B CPU (4C/ 8T, 2M Cache, 3.35/ 3.8 GHz)
Graphics	Vega GPU with 11 compute units
Memory	Up to 16 GB DDR4-3200 SDRAM (one SODIMM socket)
Panel I/O Interface	
Ethernet	4x IEEE 802.3at Gigabit PoE+ ports by Intel® I350-AM4 with screw-lock
USB	4x USB 3.1 Gen1 ports with screw-lock
Video port	1x VGA connector, supporting 1920 x 1200 resolution 1x DisplayPort connector, supporting 4096 x 2160 resolution
Serial port	1x software-programmable RS-232/ 422/ 485 port (COM1) 3x 3-wire RS-232 ports (COM2/ 3/ 4) or 1x RS-422/ 485 port (COM2)
Audio	1x 3.5mm jack for mic-in and speaker-out
Internal I/O Interface	
Mini PCI-E	1x full-size mini PCI Express socket with internal SIM socket
Expandable I/O	1x MezIO™ expansion interface for Neosys MezIO™ modules
Storage Interface	
M.2 NVMe	1x M.2 2280 M key NVMe socket (PCIe Gen3 x2)
Power Supply	
DC input	1x 3-pin pluggable terminal block for 8~35VDC DC input
Remote Ctrl.& LED output	1x3-pin pluggable terminal block for remote control and PWR LED output
Mechanical	
Dimension	82.2 mm (W) x 117.9 mm (D) x 175.8 mm (H)
Weight	1.4kg
Mounting	DIN-rail mount (standard) or wall-mount (optional)
Fan	External-accessible 80mm x 80mm fan for system heat dissipation
Environmental	
Operating temperature	-25°C ~ 70°C **/**
Storage temperature	-40°C ~85°C

Humidity	10%~90% , non-condensing
Vibration	Operating, MIL-STD-810G, Method 514.6, Category 4
Shock	Operating, MIL-STD-810G, Method 516.6, Procedure I, Table 516.6-II)
EMC	CE/ FCC Class A, according to EN 55032 & EN 55024

** For sub-zero and over 60°C operating temperature, a wide temperature HDD or Solid State Disk (SSD) is required.*

*** Operating temperature is up to 70°C only if the external-accessible fan is installed.*

1.4 Specification of POC-546

System Core	
Processor	AMD Ryzen™ V1807B CPU (4C/ 8T, 2M Cache, 3.35/ 3.8 GHz)
Graphics	Vega GPU with 11 compute units
Memory	Up to 16 GB DDR4-3200 SDRAM (one SODIMM socket)
Panel I/O Interface	
Isolated digital output	4-CH isolated digital output
Isolated digital input	4-CH isolated digital input
Ethernet	4x IEEE 802.3at Gigabit PoE+ ports by Intel® I350-AM4 with screw-lock
Video port	1x VGA connector, supporting 1920 x 1200 resolution 1x DisplayPort connector, supporting 4096 x 2160 resolution
Serial port	1x software-programmable RS-232/ 422/ 485 port (COM1) 3x 3-wire RS-232 ports (COM2/ 3/ 4) or 1x RS-422/ 485 port (COM2)
USB	4x USB 3.1 Gen1 ports with screw-lock
Audio	1x 3.5mm jack for mic-in and speaker-out
Internal I/O Interface	
Mini PCI-E	1x full-size mini PCI Express socket with internal SIM socket
Storage Interface	
M.2 NVMe	1x M.2 2280 M key NVMe socket (PCIe Gen3 x2)
SATA	1x SATA interface for 2.5" SSD/ HDD
Power Supply	
DC input	1x 3-pin pluggable terminal block for 8~35VDC DC input
Remote Ctrl.& LED output	1x3-pin pluggable terminal block for remote control and PWR LED output
Mechanical	
Dimension	82.2 mm (W) x 117.9 mm (D) x 175.8 mm (H)
Weight	1.4kg
Mounting	DIN-rail mount (standard) or wall-mount (optional)
Fan	External-accessible 80mm x 80mm fan for system heat dissipation
Environmental	
Operating temperature	-25°C ~ 70°C **/

Storage temperature	-40°C ~85°C
Humidity	10%~90% , non-condensing
Vibration	Operating, MIL-STD-810G, Method 514.6, Category 4
Shock	Operating, MIL-STD-810G, Method 516.6, Procedure I, Table 516.6-II)
EMC	CE/ FCC Class A, according to EN 55032 & EN 55024

** For sub-zero and over 60°C operating temperature, a wide temperature HDD or Solid State Disk (SSD) is required.*

*** Operating temperature is up to 70°C only if the external-accessible fan is installed.*

1.5 Dimension of POC-515/ POC-516

 **NOTE**

All measurements are in millimeters (mm).

The POC-515 and POC-516 systems share the same dimensions.

1.5.1 Front Panel View

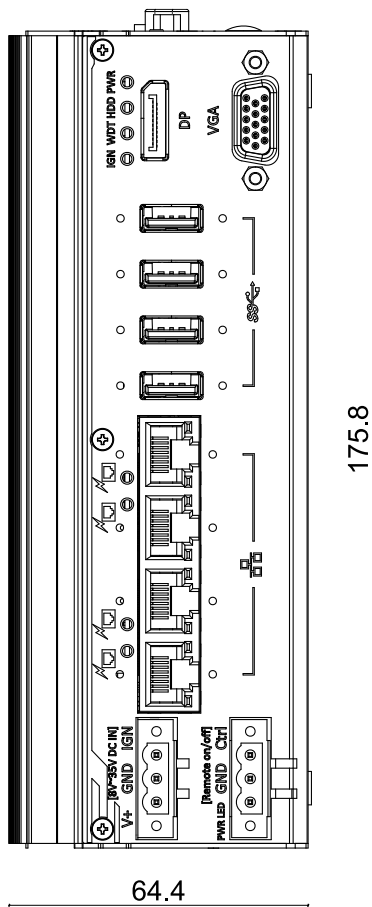

1.5.2 DIO Panel View

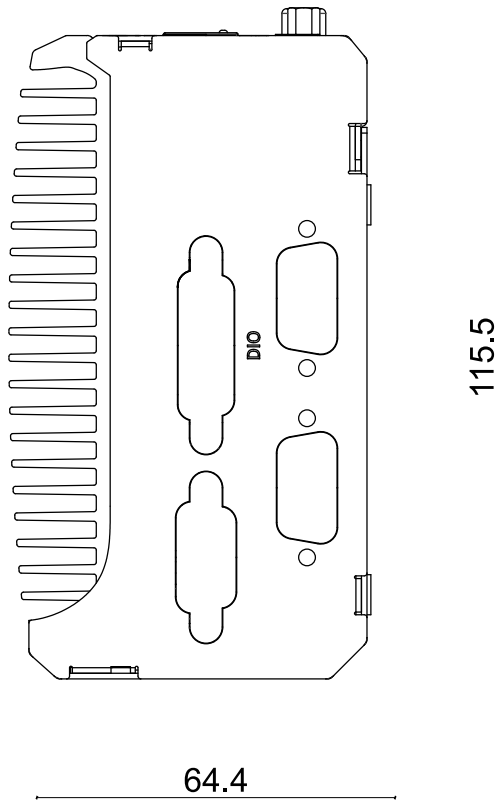

1.5.3 COM and Audio Port Panel View

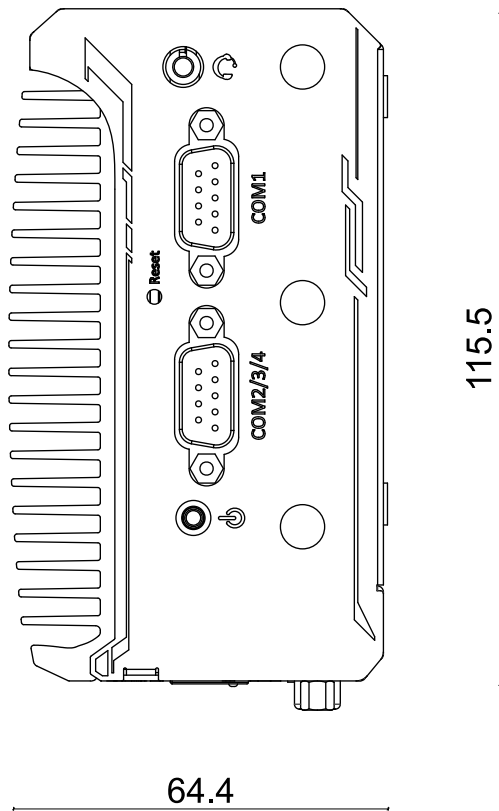

1.5.4 Bottom View

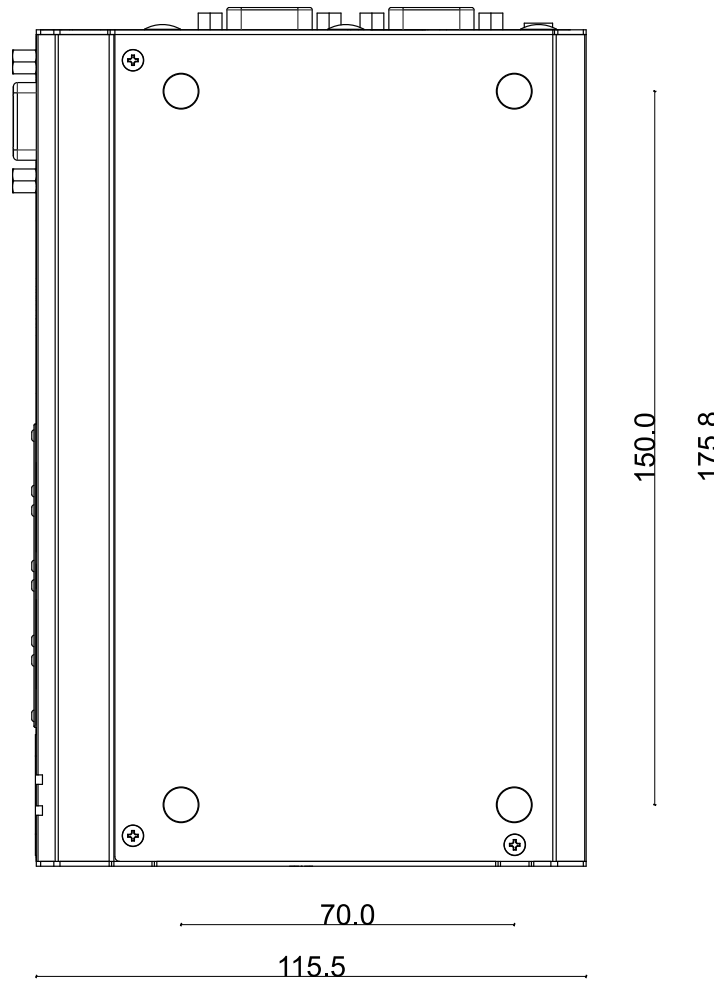

1.6 Dimension of POC-545/ POC-546

 NOTE

All measurements are in millimeters (mm).

The POC-545 and POC-546 systems share the same dimensions.

1.6.1 Front Panel View

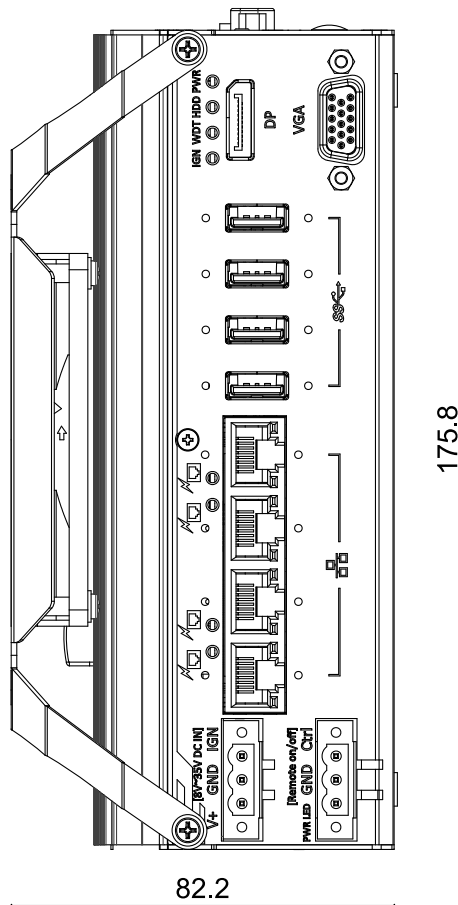

1.6.2 DIO Panel View

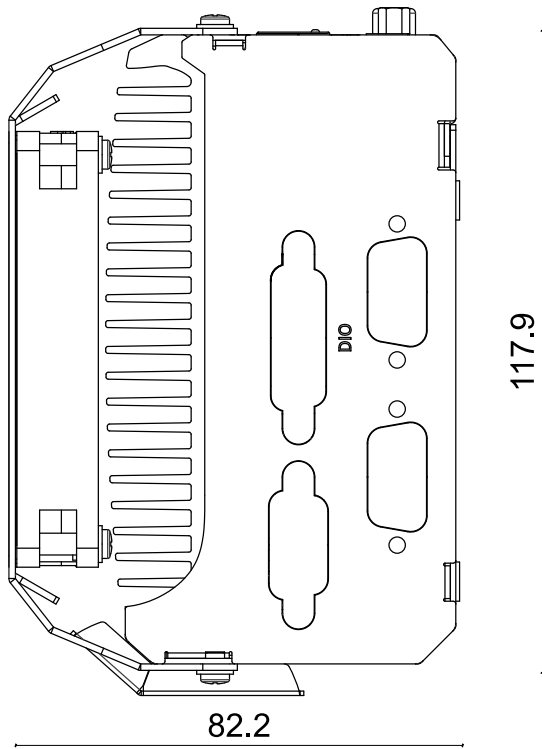

1.6.3 COM and Audio Port Panel View

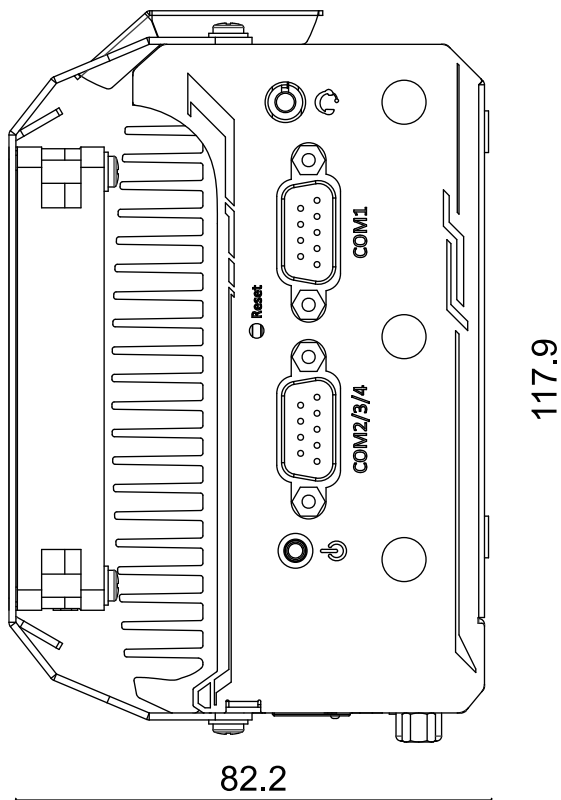

1.6.4 Bottom View

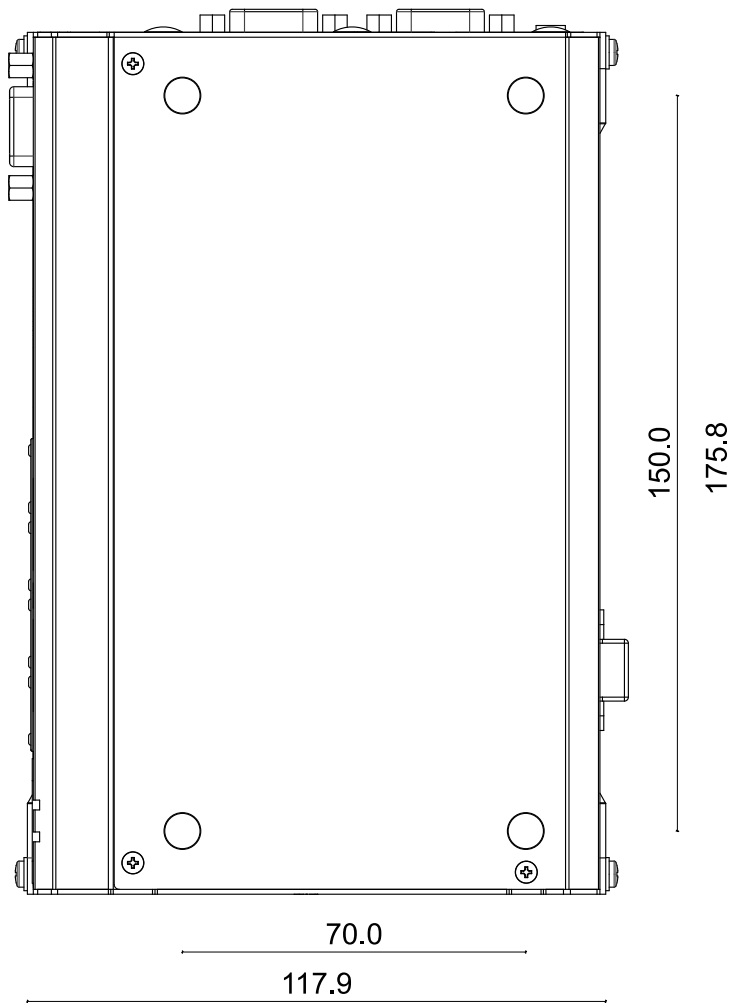

2 System Overview

Upon receiving and unpacking your POC-500 systems, please check immediately if the package contains all the items listed in the following table. If any item(s) are missing or damaged, please contact your local dealer or Neosys Technology.

2.1 Unpacking the System

Item	Description	Qty
1	POC-515/ POC-516/ POC-545/ POC-546 (If you ordered CPU/ RAM/ HDD, please verify these items)	1
2	Accessory box, which contains <ul style="list-style-type: none"> ● DIN-Rail Mount Clip ● Neosys drivers & utilities DVD ● Foot pad ● 3-pin power terminal block ● Screw pack 	1 1 4 2 1

2.2 POC-500 Series Front Panel

The front panel of POC-500 series feature rich I/O ports, it has four PoE+ Gigabit Ethernet ports, four USB 3.1 Gen1 ports, one DisplayPort, one VGA port, remote control and 3-pin terminal block for DC input.

NOTE

For demonstration purposes, POC-545/ 546 will be used in most illustrations. A dedicated illustration will be shown if the component is significantly different.

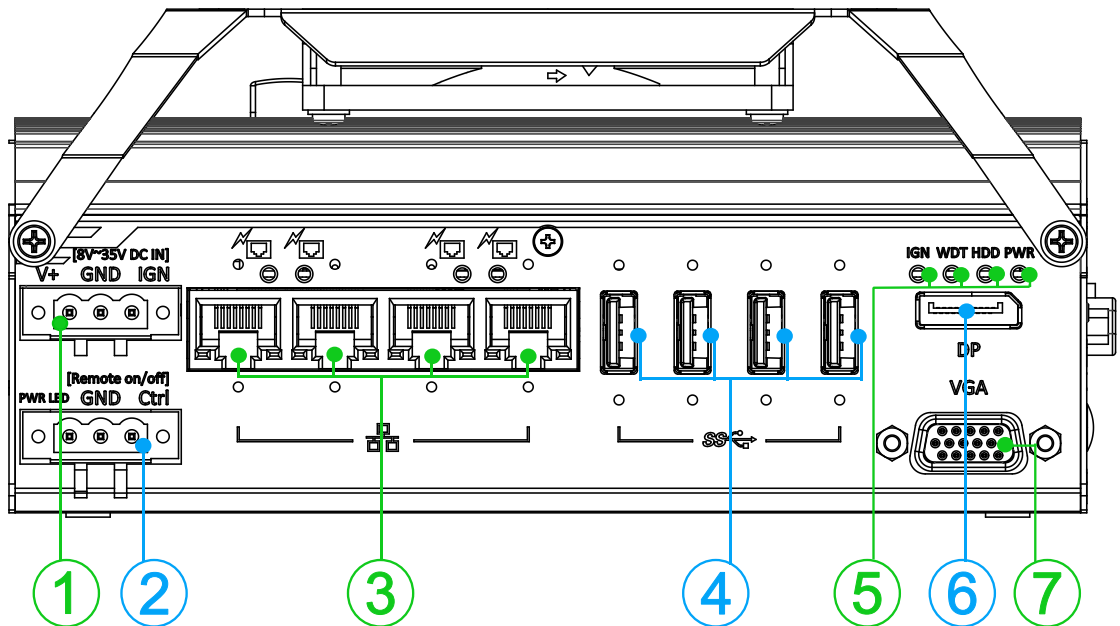

No.	Item	Description
1	3-pin DC terminal block (optional ignition input)	Compatible with DC power input from 8~35V. When the system is installed with the optional MezIO™ –V20, the terminal block can also be used for ignition signal input.
2	3-pin Remote on/off control	Allows for external switch extension when the system is placed inside a cabinet.
3	Gigabit PoE+ ports	Gigabit Power over Ethernet (PoE) port can provide both data and electric power to devices.
4	USB 3.1 Gen1 port	USB 3.1 Gen1 port, up to 5 Gbit/s data transfer bandwidth.
5	System status LED	Four system LEDs, Ignition control (IGN), Watchdog Timer (WDT), Hard Disk Drive (HDD) and Power (PWR).
6	DisplayPort output	The DisplayPort is a high-resolution graphics output supporting up to 4096 x 2160 @ 30Hz.
7	VGA port output	VGA output supports resolution up to 1920x1200@60Hz

2.2.1 3-pin Terminal Block for DC Input (Optional Ignition Input)

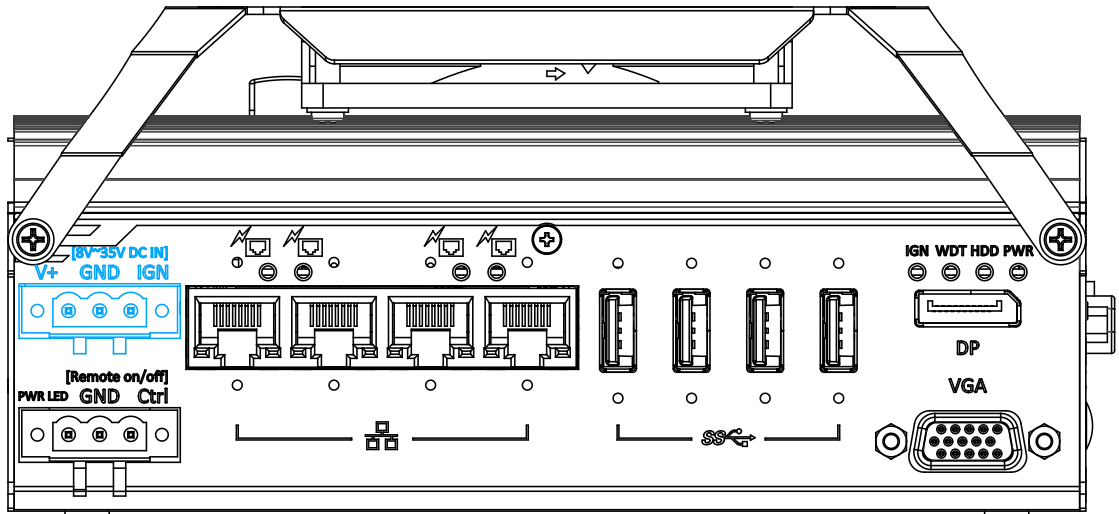

The system accepts a wide range of DC power input from 8 to 35V via a 3-pin pluggable terminal block, which is fit for field usage where DC power is usually provided. The screw clamping mechanism on the terminal block offers connection reliability when wiring DC power.

In addition to DC power input, this terminal block can also accept ignition signal input (IGN) when you have MeziO™ module with IGN function installed..



WARNING

Please make sure the voltage of DC power is correct before you connect it to the system. Supplying a voltage over 35V will damage the system.

2.2.2 3-pin Remote On/ Off

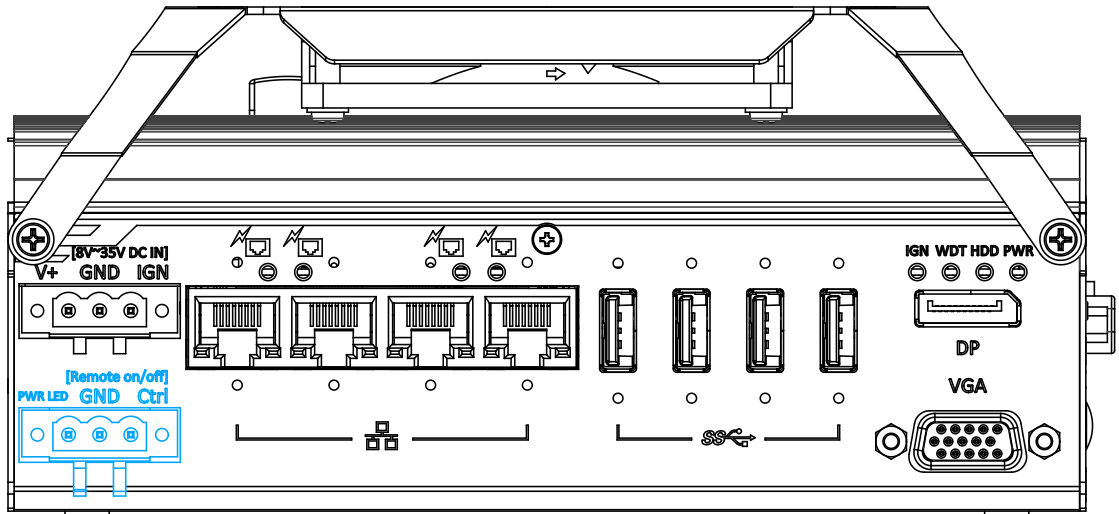

The “Remote On/ Off” 3-pin connection allows for external switch extension. It is useful when the system is placed in a cabinet or a not easily accessed location. You may connect an external remote with an external status LED indicator (15mA) by connecting to PWR LED and GND.

2.2.3 IEEE 802.3at Power over Ethernet Port

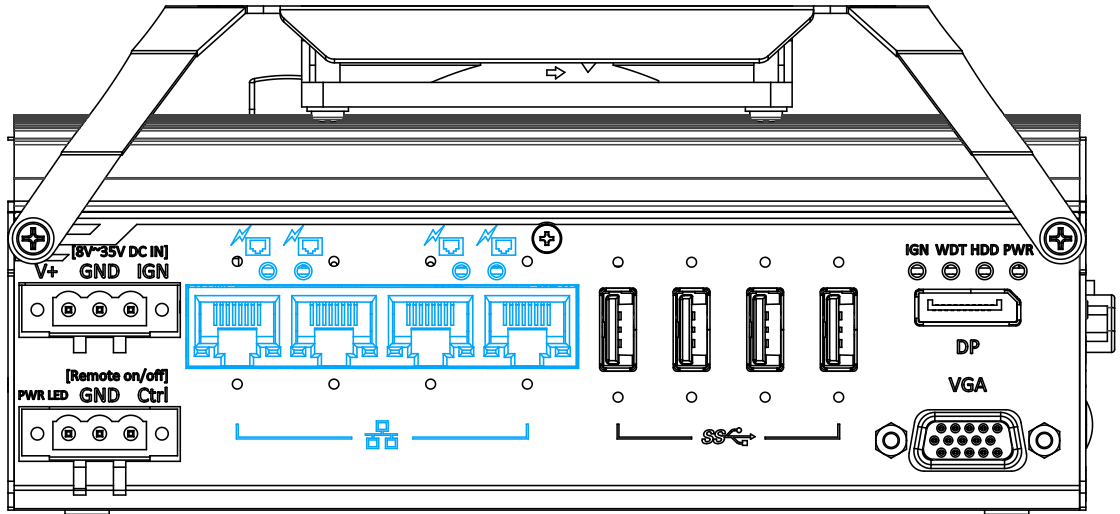

The Gigabit Power over Ethernet (PoE) port supply power and data on a standard CAT-5/CAT-6 Ethernet cable. Acting as a PSE (Power Sourcing Equipment), compliant with IEEE 802.3at, each port delivers up to 25W to a Powered Device (PD). PoE automatically detects and determine if the connected device is PoE PD or not before supplying power, making it compatible with standard Ethernet devices as well.

Active/Link LED (Right)

LED Color	Status	Description
Green	Off	Ethernet port is disconnected
	On	Ethernet port is connected and no data transmission
	Flashing	Ethernet port is connected and data is transmitting/receiving

Speed LED (Left)

LED Color	Status	Description
Green or Orange	Off	10 Mbps
	Green	100 Mbps
	Orange	1000 Mbps

2.2.4 USB 3.1 Gen1

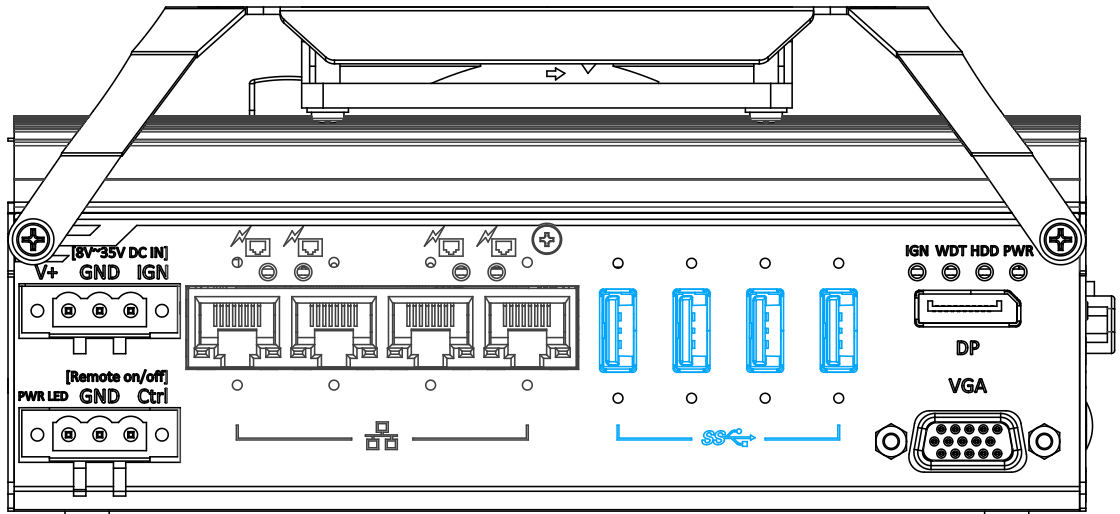

The system offers four USB 3.1 Gen1 (SuperSpeed USB) ports on its front panel. They are backward compatible with USB 2.0, USB 1.1 and USB 1.0 devices. Legacy USB support is also provided so you can use USB keyboard/mouse in DOS environment while USB 3.1 Gen1 driver is supported natively in Windows 10.

2.2.5 System Status LED

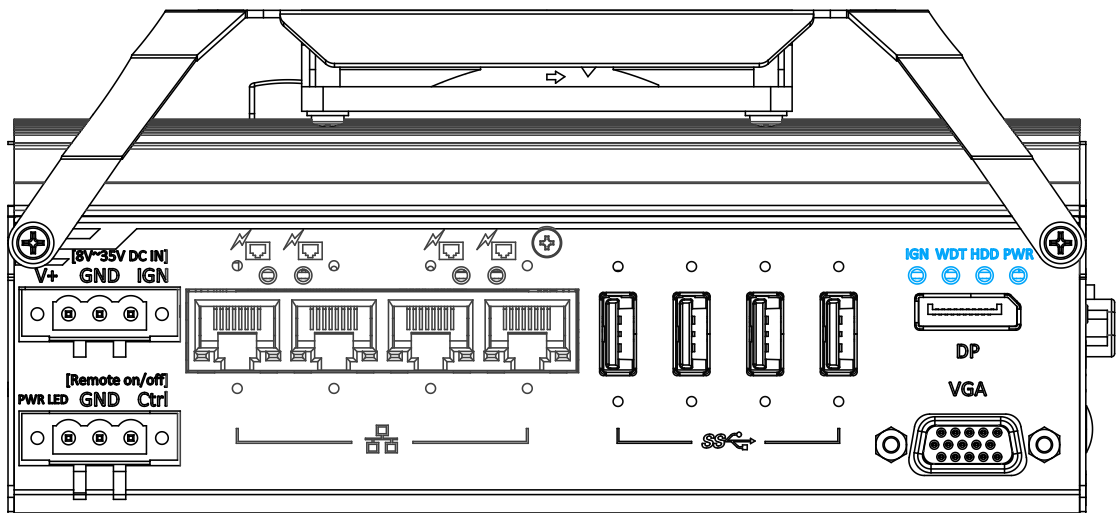

There are four LED indicators on the front panel: IGN, WDT, HDD and PWR. The descriptions of these four LEDs are listed in the following table.

Indicator	Color	Description
IGN	Yellow	Ignition power control, lid when IGN signal is applied.
WDT	Yellow	Watchdog timer indicator, flashing when watchdog timer has started
HDD	Red	Hard drive indicator, flashing when SATA HDD is active
PWR	Green	Power indicator, lid when system is on

2.2.6 DisplayPort

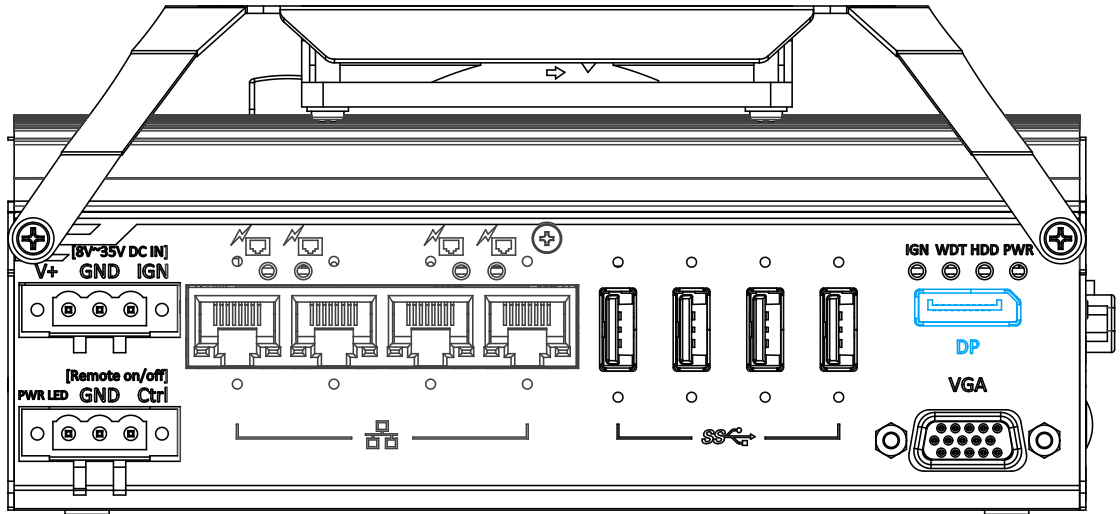

The system has a DisplayPort (DP) output which is a digital display interface that mainly connect video source and carry audio to a display device. When connecting a DP, it can deliver up to 4K UHD (4096 x 2160 @ 30Hz) in resolution. The system is designed to support passive DP adapter/ cable. You can connect to other display devices using DP-to-HDMI cable or DP-to-DVI cable.



DP-to-HDMI



DP-to-DVI

The system supports dual independent display outputs by connecting display devices to VGA and DisplayPort connection. To support dual display outputs and achieve best DisplayPort output resolution in Windows, you need to install corresponding graphics drivers. Please refer to section [OS Support and Driver Installation](#) for details.

2.2.7 VGA Port

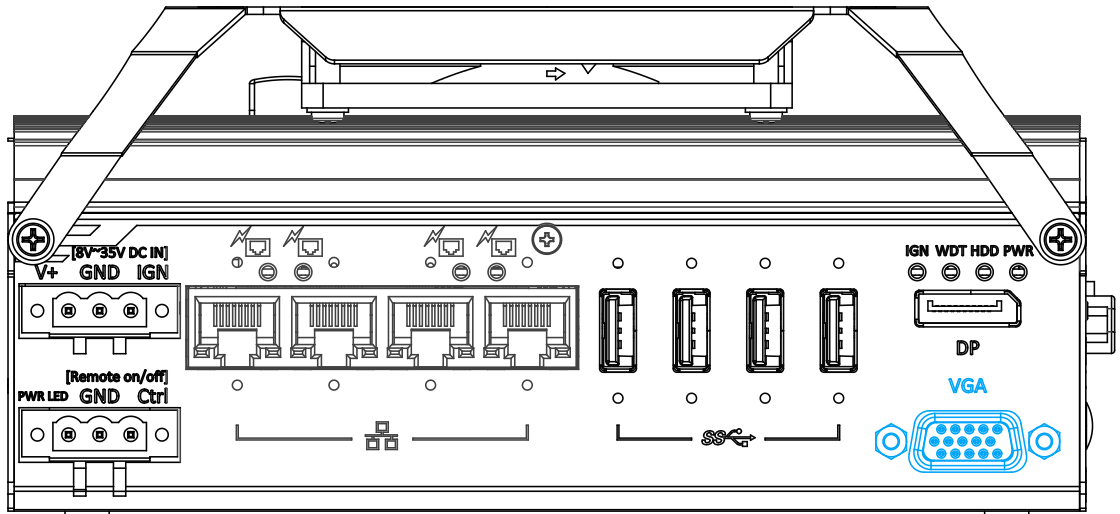

VGA connector is the most common video display connection. The VGA output supports up to 1920x1200@60Hz resolution.

The system supports dual independent display outputs by connecting display devices to VGA and DisplayPort connection. To support dual display outputs and achieve best VGA output resolution in Windows, you need to install corresponding graphics drivers. Please refer to section [OS Support and Driver Installation](#) for details.





NOTE

Please make sure your VGA cable includes SDA and SCL (DDC clock and data) signals for correct communication with monitor to get resolution/timing information. A cable without SDA/ SCL can cause blank screen on your VGA monitor due to incorrect resolution/timing output.

2.3 COM Port Panel

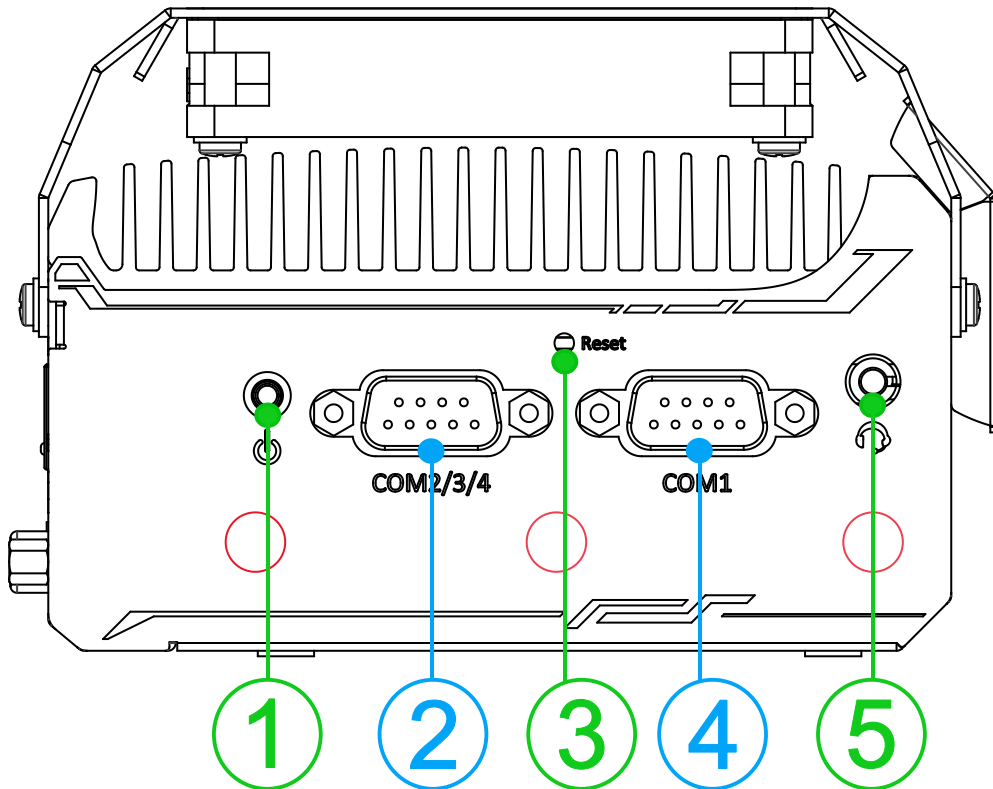
The COM port panel of POC-500 series features additional I/O functions, such as COM ports, 3.5mm speaker-out/ microphone-in jack, and reserved antenna openings for SMA antenna installation. In addition, the power and reset button can also be located on this panel.



No.	Item	Description
1	Power button	Use this button to turn on or shutdown the system.
2	COM port 2/ 3/ 4	Can be configured as: COM2: single RS-422/ 485 port COM2/ COM3/ COM4: three 3-wire RS-232 ports
3	Reset button	Use this button to manually reset the system.
4	COM port 1	Software programmable RS-232/ 422/ 485 port.
5	3.5mm speaker-out/ microphone-in jack	3.5mm jack for speaker-out or microphone-input.
6		Opening reserved for SMA antenna installation.

2.3.1 Power Button

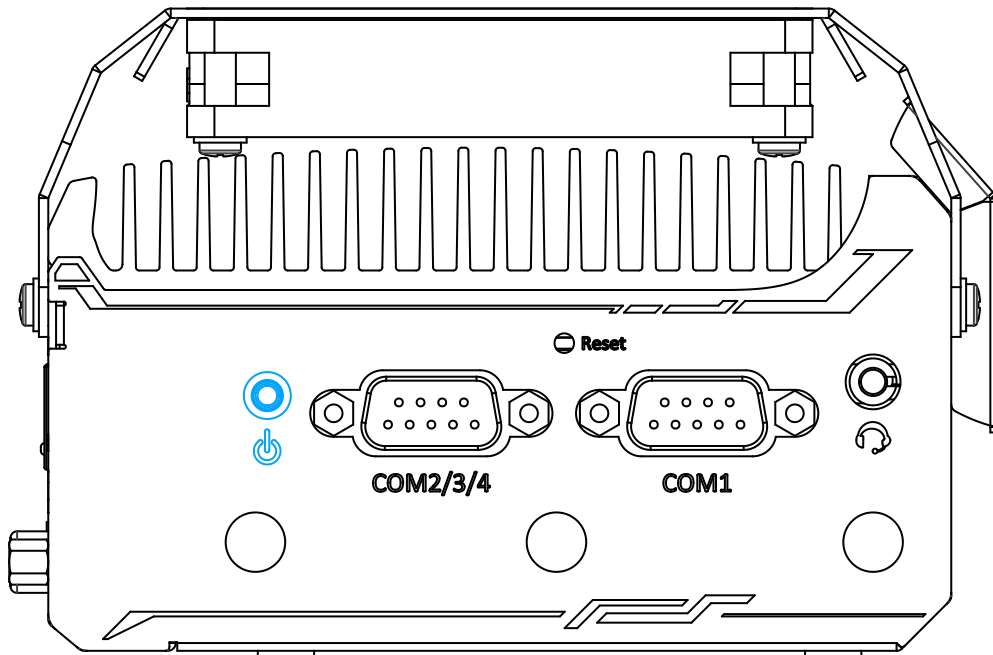

The power button is a non-latched switch for ATX mode on/off operation. Press to turn on the system, PWR LED should light up and to turn off, you can either issue a shutdown command in the OS, or just press the power button. In case of system halts, you can press and hold the power button for 5 seconds to force-shutdown the system. Please note that there is a 5 seconds interval between two on/off operations (i.e. once turning off the system, you will need to wait for 5 seconds to initiate another power-on operation).

2.3.2 COM 1 Port

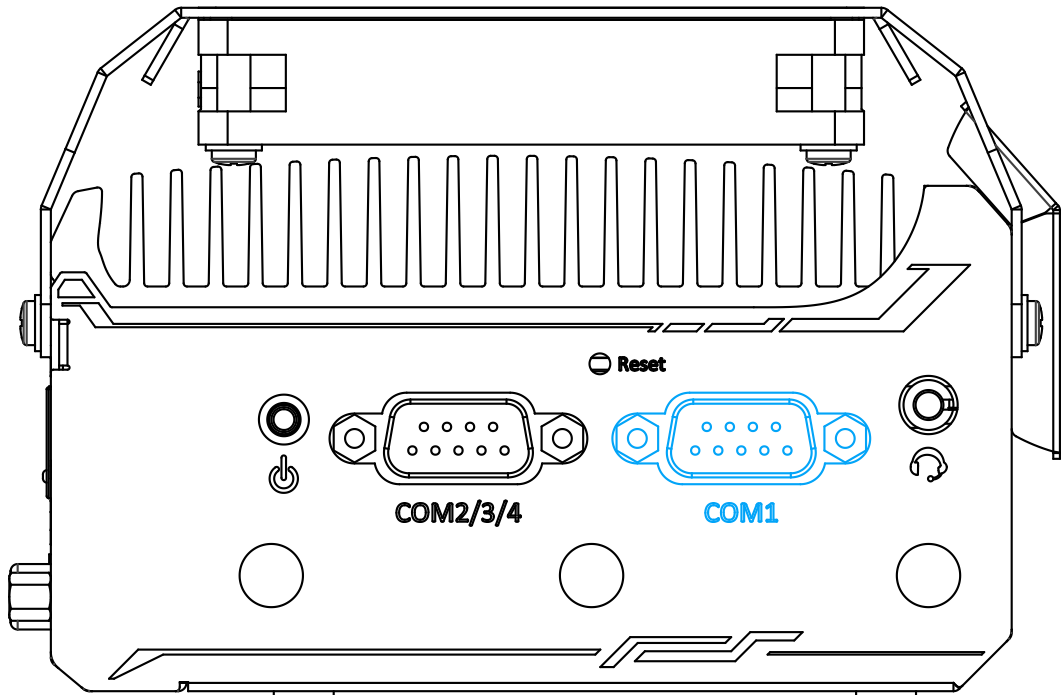

Implemented using industrial-grade ITE8786 Super IO chip (-40 to 85°C) and provide up to 921600 bps baud rate, COM1 is a software-configurable RS-232/422/485 port via 9-pin D-Sub male connector. The operation mode, slew rate and termination of COM1 can be set in BIOS setup utility. The following table describes the pin definition of COM ports.

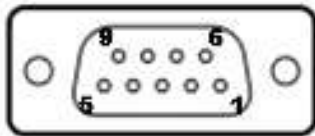

Pin#	COM1		
	RS-232 Mode	RS-422 Mode	RS-485 Mode (Two-wire 485)
1	DCD		
2	RX	422 TXD+	485 TXD+/RXD+
3	TX	422 RXD+	
4	DTR	422 RXD-	
5	GND	GND	GND
6	DSR		
7	RTS		
8	CTS	422 TXD-	485 TXD-/RXD-
9	RI		

2.3.3 COM Port (COM2/ COM3/ COM4)

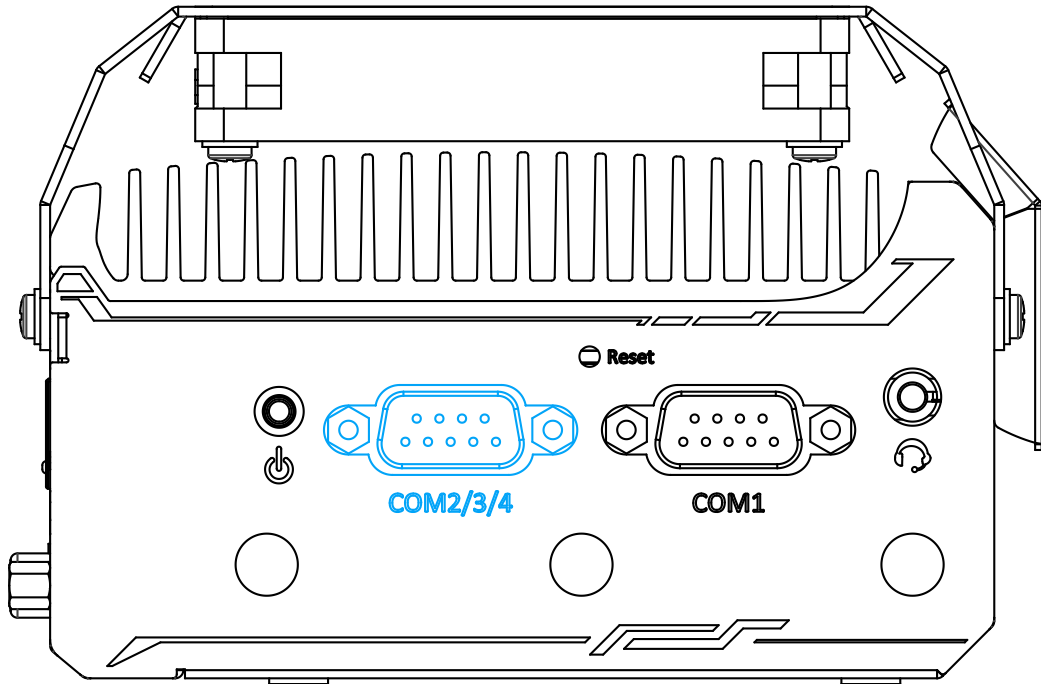

Implemented using industrial-grade ITE8786 Super IO chip (-40 to 85°C) and provide up to 921600 bps baud rate, the D-Sub male connector (COM2/ 3/ 4) can be configured in the BIOS as single RS-422/ 485 port (COM2) or three 3-wire RS-232 ports (COM2/COM3/COM4). Please refer to [COM2/ 3/ 4 Port Configuration](#) for configuring operation mode. An optional 1-to-3 Y-cable is available to connect three RS-232 devices.

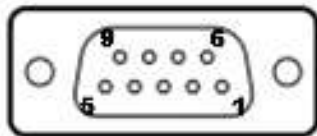

COM2/ 3/ 4 Pin



1-to-3 Y-cable

The following table describes the pin definition of the COM port

	3-port RS-232 COM2/ 3/ 4		
Pin#	COM2	COM3	COM4
1			
2	RX		
3	TX		
4		TX	
5	GND	GND	GND
6		RX	
7			TX
8			RX
9			

	Single port RS-422/ 485 COM2	
Pin#	RS-422	RS-485
1		
2	TxD+	TxD+/ RxD+
3	RxD+	
4	RxD-	
5	GND	GND
6		
7		
8	TxD-	TxD-/ RxD-
9		

2.3.4 4-Pole 3.5mm Microphone-in/ Speaker-out Jack

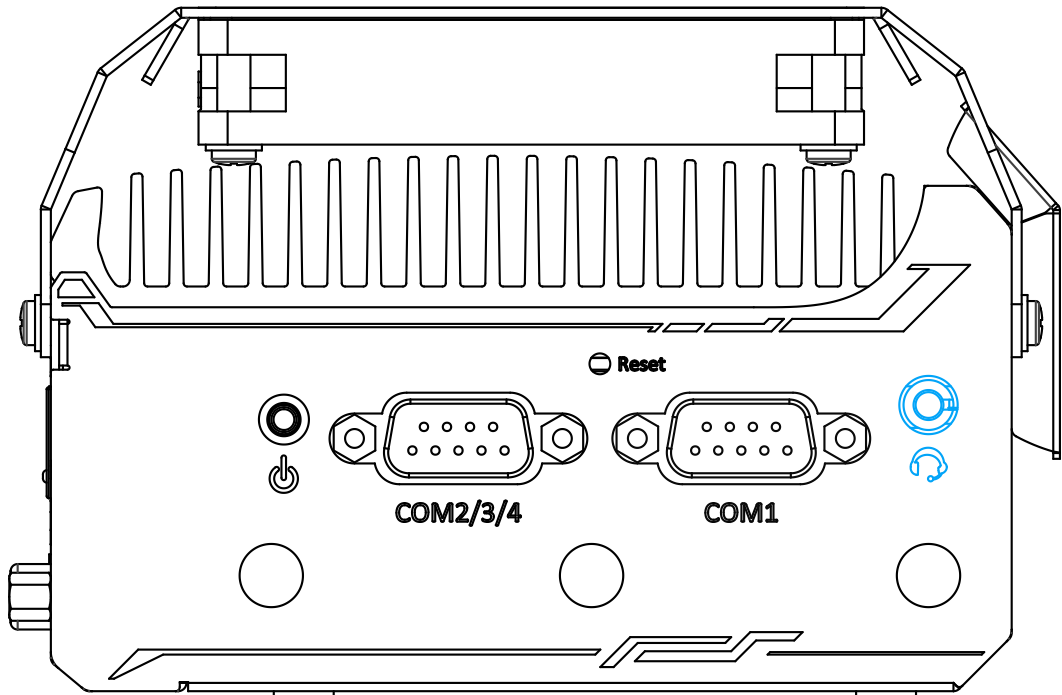

There is a female 4-pole  audio jack for headphone (speaker) output and microphone input. To utilize the audio function in Windows, you need to install corresponding drivers. Please refer to the section, [Driver Installation](#).

2.3.5 SMA Antenna Opening

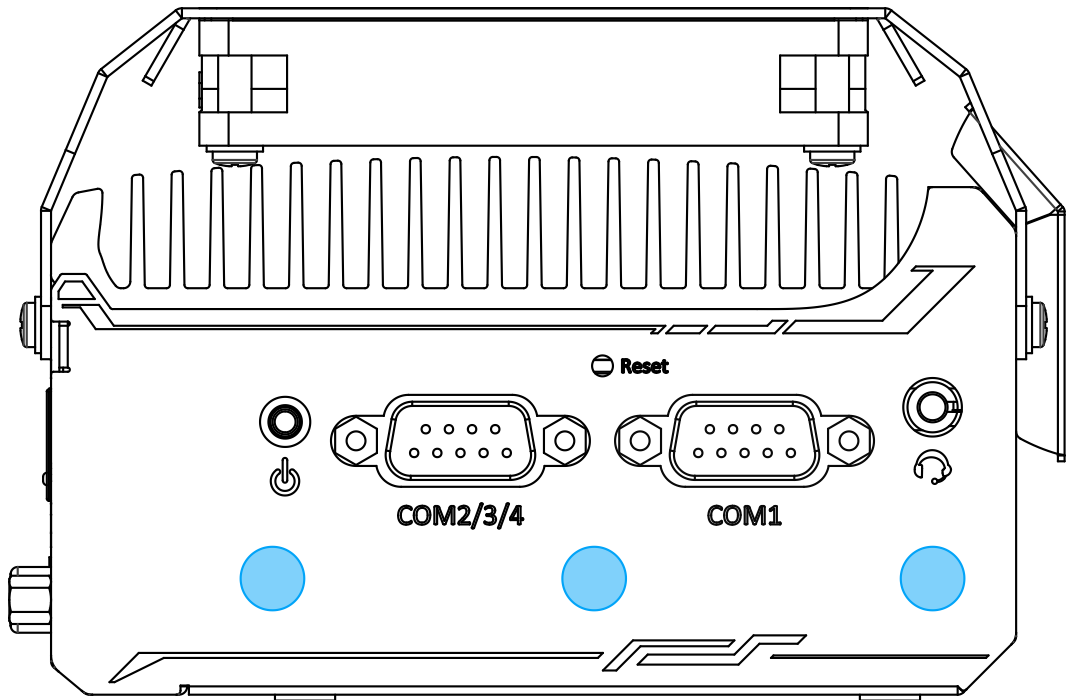

The system offers three SMA antenna openings reserved for SMA antenna installations. Users can take advantage of these three openings when installing mini-PCIe module for wireless communication reception such as 3G, 4G, GPS or WiFi.

2.4 CMOS Reset Button

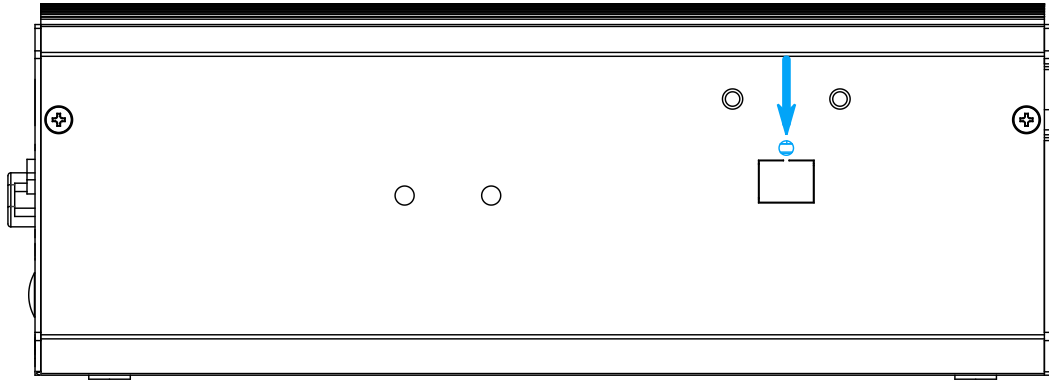

Positioned on the rear panel (opposite the IO panel), indicated by the **blue arrow**, the CMOS Reset button is used to manually reset the motherboard BIOS in case of system halt or malfunction. To avoid unexpected operation, it is purposely placed behind the panel. To reset, please use the tip of a pen, press and hold for at least 5 seconds to reset the BIOS.

2.5 Reserved Port Opening Panel

The reserved port opening panel has reserved openings for DIO or extra COM ports. Choose from a wide range Neusys' MeziO™ modules and find one that best suit your needs.

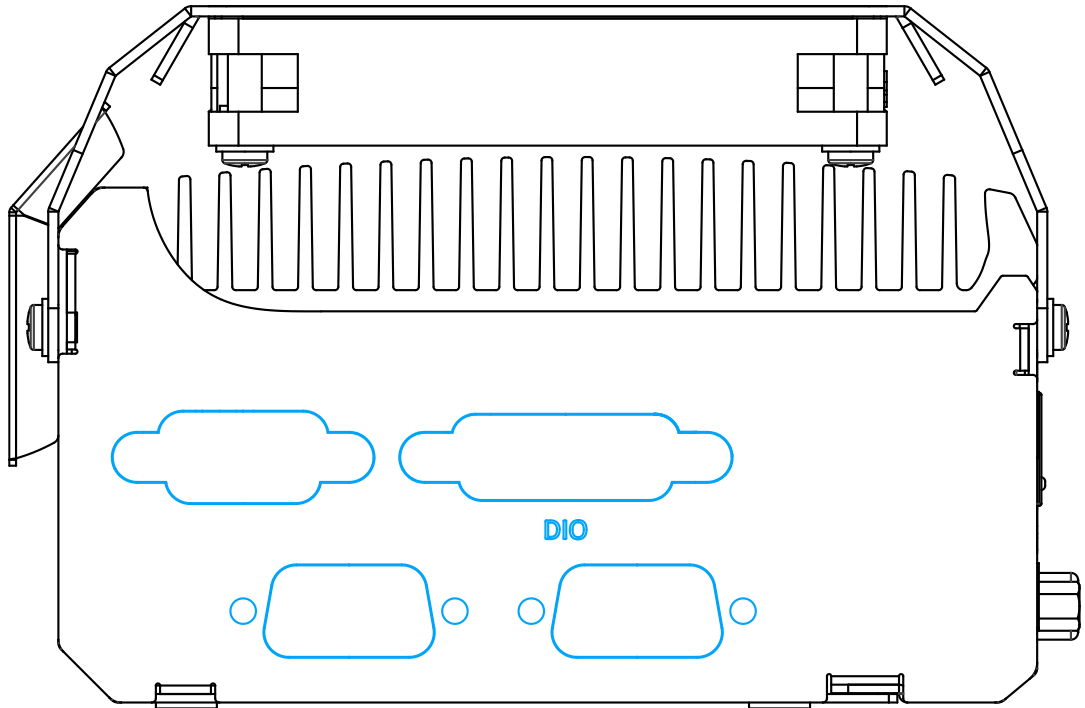

2.6 Internal I/O

The system's internal I/O connectors consist of an mini-PCIe slot with SIM slot, an M.2 slot for NVMe SSD, SO-DIMM socket, slot and a MezIO™ port for application-oriented expansion purposes.

2.6.1 Full-size mini-PCIe Slot and SIM Socket

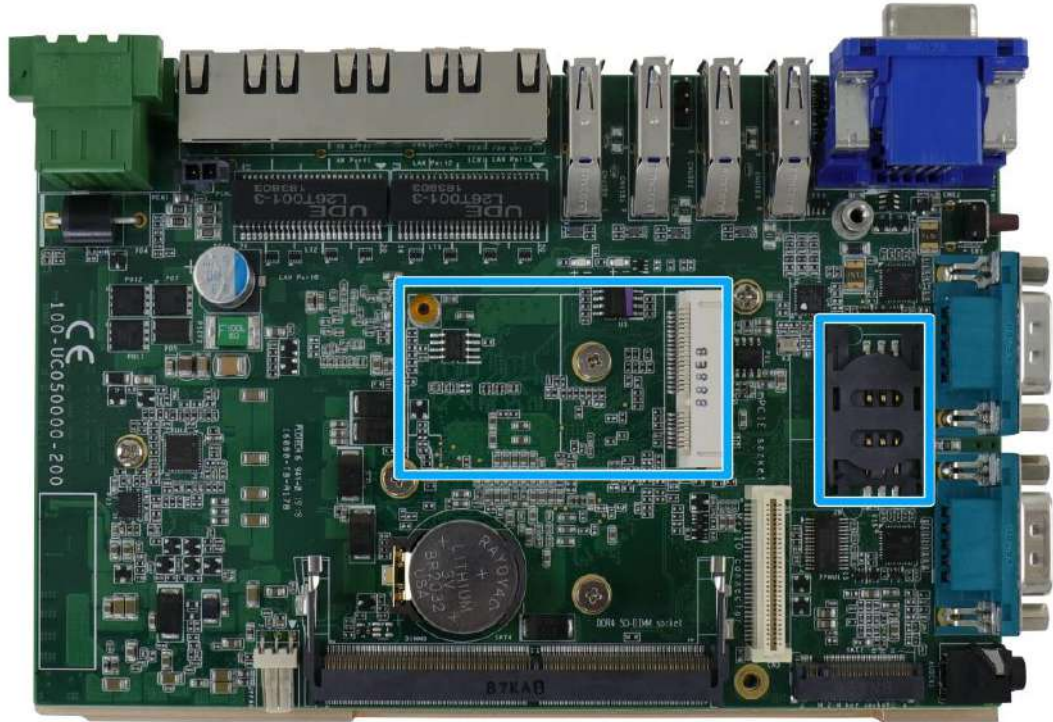

The system provides a full-size mini-PCIe socket. The mini-PCIe socket is designed with SIM card support. With a SIM card installed, your system can access the internet via your network provider's 3G/ 4G network.

For wireless (WIFI/ 3G/ 4G) communication, there are SMA antenna openings on system side panels.



COM port panel antenna openings

mini-PCIe Pin Definition

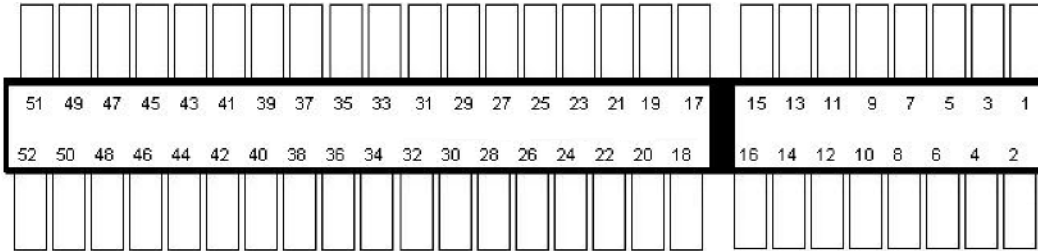

Pin #	Signal	Pin #	Signal
1	WAKE#	2	+3.3Vaux
3	COEX1	4	GND
5	COEX2	6	+1.5V
7	CLKREQ#	8	UIM_PWR
9	GND	10	UIM_DATA
11	REFCLK-	12	UIM_CLK
13	REFCLK+	14	UIM_RESET
15	GND	16	UIM_VPP
Mechanical Key			
17	Reserved* (UIM_C8)	18	GND
19	Reserved* (UIM_C4)	20	W_DISABLE#
21	GND	22	PERST#
23	PERn0	24	+3.3Vaux
25	PERp0	26	GND
27	GND	28	+1.5V
29	GND	30	SMB_CLK
31	PETn0	32	SMB_DATA
33	PETp0	34	GND
35	GND	36	USB_D-
37	GND	38	USB_D+
39	+3.3Vaux	40	GND
41	+3.3Vaux	42	LED_WWAN#
43	GND	44	LED_WLAN#
45	Reserved	46	LED_WPAN#
47	Reserved	48	+1.5V
49	Reserved	50	GND
51	Reserved	52	+3.3Vaux



WARNING

Some off-the-shelf mini-PCIe 4G modules use 1.8V I/O signals instead of 3.3V I/O and may cause signal interference. Installing an incompatible 4G module may damage the system or the module itself may be damaged. Please consult with Neousys when in doubt!

2.6.2 M.2 2280 (M Key) Slot for NVMe SSD

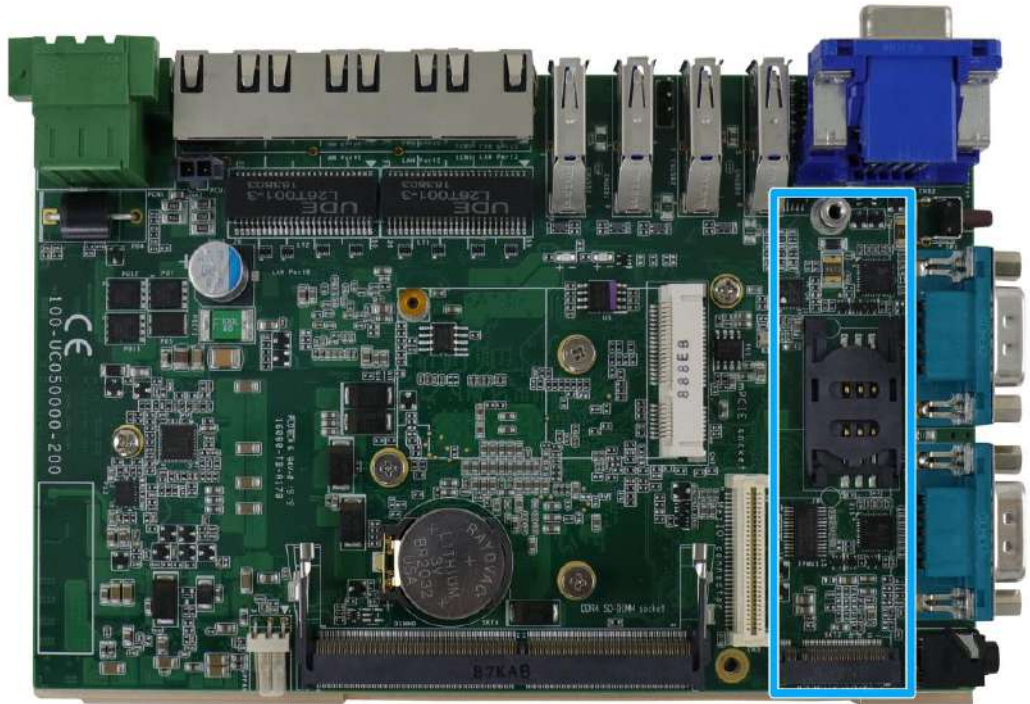

The system has an M.2 2280 slot (M key PCIe Gen3 x2) to install an NVMe SSD for the ultimate disk read/ write performance. An NVMe SSD offers doubled the disk read/ write speed performances over 2.5" SSDs.

M.2 (M Key) Slot Pin Definition

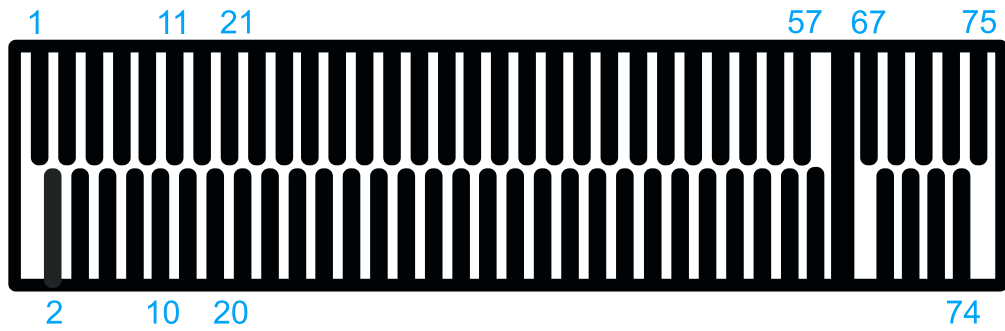

Pin #	Signal	Pin #	Signal
1	GND	2	+3V3
3	GND	4	+3V3
5	-	6	-
7	-	8	-
9	GND	10	DAS/DSS N
11	-	12	+3V3
13	-	14	+3V3
15	GND	16	+3V3
17	-	18	+3V3
19	-	20	-
21	GND	22	-
23	-	24	-
25	-	26	-
27	GND	28	-
29	PERN1	30	-
31	PERP1	32	-
33	GND	34	-
35	PETN1	36	-
37	PETP1	38	-
39	GND	40	-
41	PERn0 +	42	-
43	PERp0 -	44	-
45	GND	46	-
47	PETn0 -	48	-
49	PETp0 +	50	PERST_N
51	GND	52	-
53	REFCLKN	54	-
55	REFCLKP	56	-
57	GND	58	-
Mechanical Key			
67	-	68	SUSCLK
69	PEDET	70	+3V3
71	GND	72	+3V3
73	GND	74	+3V3
75	GND		

2.6.3 SO-DIMM Socket

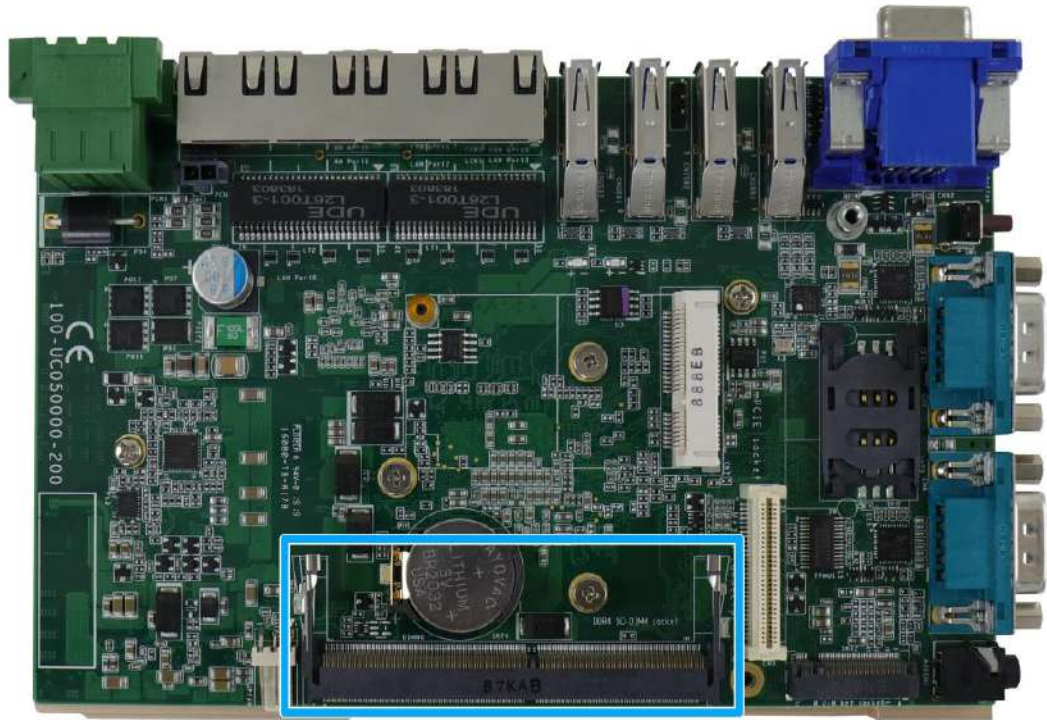

The system supports one 260-pin SO-DIMM socket for installing DDR4 memory module up to 16GB in capacity. Please refer to the following table for details.

System / Memory type	POC-515/ POC-516	POC-545/ POC-546
DDR4-2400	Supported	Supported
DDR4-3200	Not supported	Supported (single rank only)

2.7 MezIO™ Interface

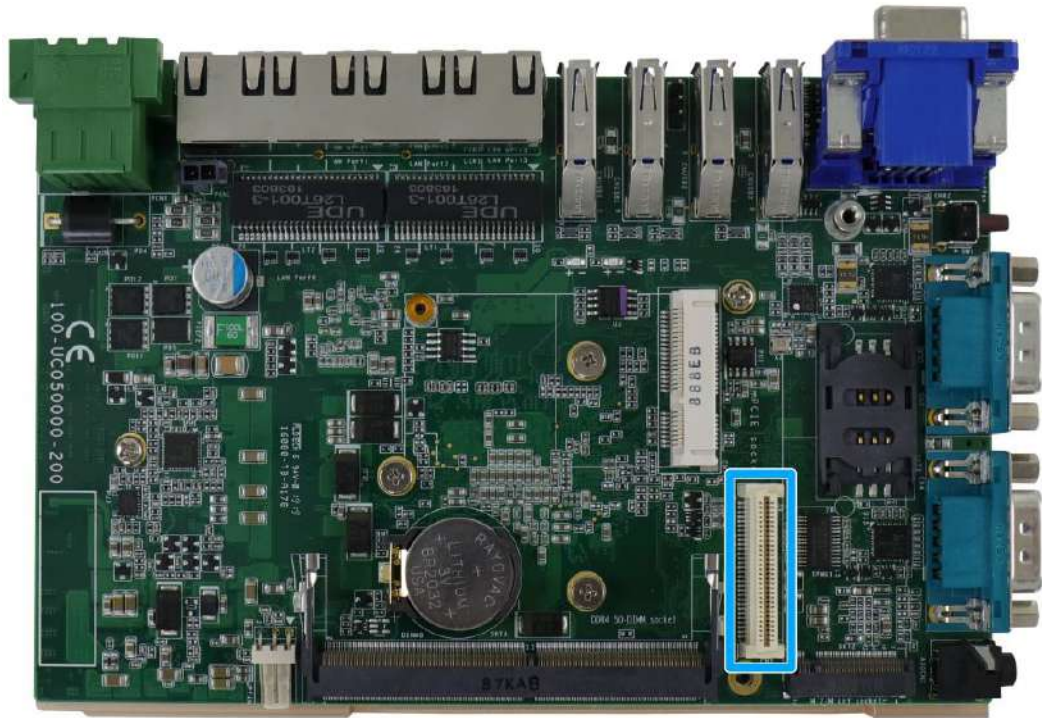

MezIO™ is an innovative interface designed for integrating application-oriented I/O functions into an embedded system. It offers computer signals, power rails and control signals via a high-speed connector. MezIO™ is also mechanically reliable benefited from its 3-point mounted mezzanine structure. A MezIO™ module can leverage these signals to implement comprehensive I/O functions.

The system incorporates MezIO™ interface and universal mechanical design to accommodate Neusys' standard MezIO™ modules. For customers who want to develop their own MezIO™ module, Neusys provides MezIO™ design documents on a NDA basis. Please contact Neusys for further information.

2.7.1 MezIO™ Interface Pin Definition

MezIO™ interface leverages FCI BERGSTAK® board-to-board connector to provide interconnectivity of high-speed signals. The receptacle part on the PCBA is FCI 61082-063402LF while the plug part on the MezIO™ module is FCI 61083-064402LF. Please refer to the following table for signal definition of its 60-pos connector.

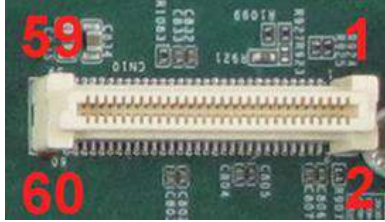

Function Description	Signal	Pin#	Pin#	Signal	Function Description
Reserved	Reserved	1	2	PCIE_TXP_0	PCIe data pair
Reserved	Reserved	3	4	PCIE_TXN_0	PCIe data pair
Reserved	Reserved	5	6	GND	Ground
Reserved	Reserved	7	8	PCIE_RXP_0	PCIe data pair
System S3 signal	SLP_S3#	9	10	PCIE_RXN_0	PCIe data pair
Ground	GND	11	12	CLK100_P_0	PCIe clock pair
Reserved	Reserved	13	14	CLK100_N_0	PCIe clock pair
Ground	GND	15	16	GND	Ground
Reserved	UID_LED	17	18	PCIE_TXP_1	PCIe data pair
Platform reset signal	PLT_RST#	19	20	PCIE_TXN_1	PCIe data pair
USB data pair	USBP5_N	21	22	PCIE_RXP_1	PCIe data pair
USB data pair	USBP5_P	23	24	PCIE_RXN_1	PCIe data pair
Ground	GND	25	26	GND	Ground
SMB bus	SMB_DATA	27	28	CLK100_P_1	PCIe clock pair
SMB bus	SMB_CLK	29	30	CLK100_N_1	PCIe clock pair
*PCIe/ SATA data pair B	PCIE_TXP_3/ SATA data pair B+	31	32	GND	Ground
*PCIe/ SATA data pair B	PCIE_TXN_3/ SATA data pair B-	33	34	PCIE_TXP_2	*PCIe data pair
Ground	GND	35	36	PCIE_TXN_2	*PCIe data pair
*SATA/ PCIe data pair A	PCIE_RXP_3/ SATA data pair A-	37	38	GND	Ground
*SATA/ PCIe data pair A	PCIE_RXN_3/ SATA data pair A+	39	40	PCIE_RXP_2	*PCIe data pair
Power button signal	PWRBTN#	41	42	PCIE_RXN_2	*PCIe data pair
Reserved	Reserved	43	44	RXD5	SIO COM5
APU GPIO	APU GPIO	45	46	TXD5	SIO COM5
APU GPIO	APU GPIO	47	48	RXD6	SIO COM6
APU GPIO	APU GPIO	49	50	TXD6	SIO COM6
Ground	GND	51	52	GND	Ground
3.3V power	P3V3	53	54	P1V8	1.8V power
3.3V power	P3V3	55	56	GND	Ground
5V power	P5V	57	58	P12V	12V power
5V power	P5V	59	60	P12V	12V power

* PCIe lanes 2/ 3 are only supported by A2 version PCB. If you are unsure, please contact your sales representative or Neousys.

2.7.2 MezIO™ Modules for POC-500 Series

Neousys offers MezIO™ modules to expand I/O functions for Neousys systems. With the addition of a MezIO™ module into your system, it offers extra RS-232/ 422/ 485 ports, isolated digital I/ O, 2.5" HDD/ SSD accommodation or ignition power control.

Model	Description
MezIO-R11	SATA port
MezIO-R12	SATA port + 4x isolated DI/ & 4x isolated DO
MezIO-C180-50	4-port RS-232/ 422/ 485 + 4-port RS-232
MezIO-C181-50	4-port RS-232/ 422/ 485 + 4-port RS-422/ 485
MezIO-D220-50*	8-CH isolated DI + 8-CH isolated DO
MezIO-D230-50*	16-CH isolated DI + 16-CH isolated DO
MezIO-V20	16-mode ignition power control + 1x mini-PCIe socket
MezIO-U4	4-port USB 3.1 Gen1
MezIO-G4	4x GigE ports by 4x Intel® I210 controllers, supporting 9.5 kB jumbo frame



NOTE

*When a MezIO-D230 or MezIO-D220 module is installed, the mini PCIe slot can not be used due to mechanical interference.

3 System Installation

Before disassembling the system enclosure and installing components and modules, please make sure you have done the following:

- It is recommended that only qualified service personnel should install and service this product to avoid injury or damage to the system.
- Please observe all ESD procedures at all times to avoid damaging the equipment.
- Before disassembling your system, please make sure you have the module/ component you wish to install at hand and have all the necessary tools.
- Before disassembling your system, please make sure the system has powered off, all cables and antenna (power, video, data, etc.) are disconnected.
- Place the system on a flat and sturdy surface (remove from mounts or out of server cabinets) before proceeding with the installation/ replacement procedure.

3.1 Disassembling the System Enclosure

 **NOTE**

For POC-515/ 516 systems, you may skip steps 2 & 3.

To install internal components such as M.2 SSD, memory module, mini-PCIe or MezIO™ module, you need to disassemble the system enclosure. Please refer to the following procedures:

1. Remove the two (2) screws indicated in red.



POC-515/ POC-516 systems



POC-545/ POC-546 systems

2. Remove the two (2) screws (indicated in red) and remove the power cable cover.

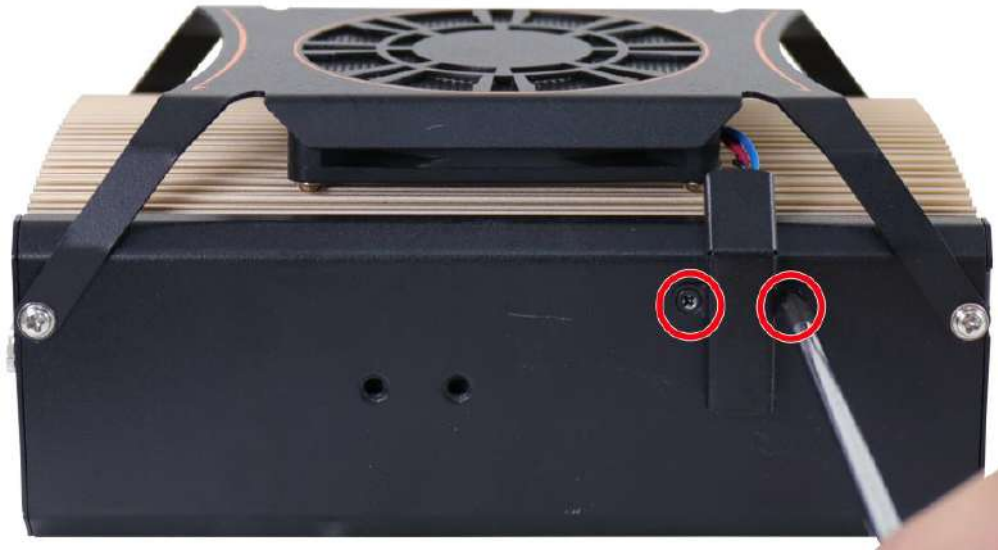

3. Unplug the 3-pin fan power connector.

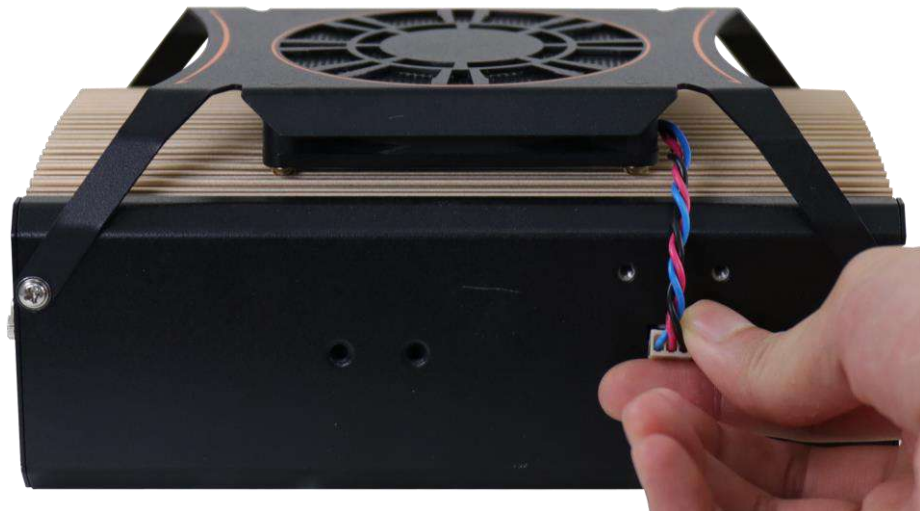

- Remove the two (2) screws (indicated in red). For POC-545/ 546 systems, please also separate the fan from the enclosure.



POC-515/ POC-516 systems



POC-545/ POC-546 systems

- Turn the system upside down and place it on a flat sturdy surface. Unscrew the three (3) screws (indicated in red) and gently remove the L-shaped panel.



6. Unscrew the two (2) VGA hexa bolt screws (indicated in red); unscrew the three (3) screws (indicated in blue) and gently remove the front I/O panel.



7. Unscrew the two (2) screws (indicated in red) to remove the DRAM/ NVMe SSD heat spreader and unscrew the screw (indicated in blue) to remove the DIO panel.

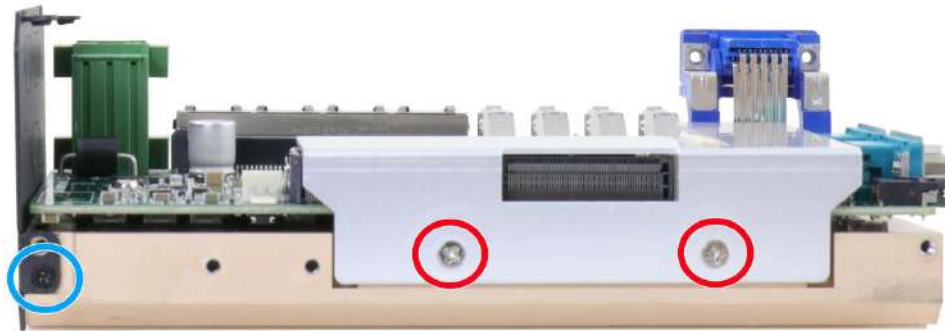

8. With external panels and DRAM/ NVMe heat spreader removed, you are ready to install internal components.
9. [Reinstall the enclosure](#) when done.

3.2 Installing Internal Components

3.2.1 DDR4 SO-DIMM Installation

There is one SO-DIMM memory slot on POC-500 motherboard. Please follow the procedures below to install the memory module.

1. [Disassemble the system enclosure.](#)
2. Locate the SO-DIMM slot on the motherboard shown below.

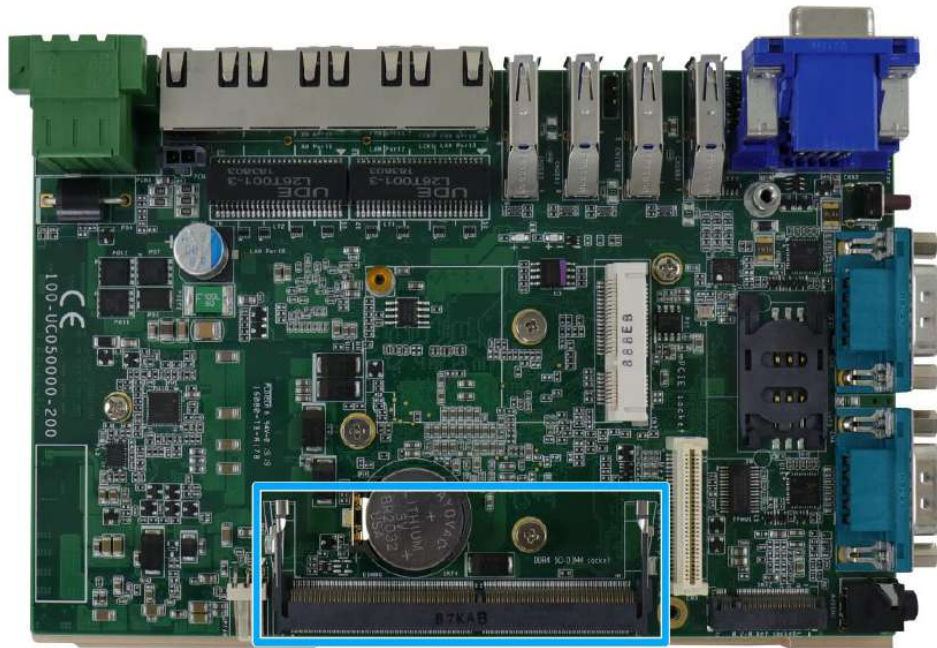

3. **To install**, insert the gold finger end of the SO-DIMM on a 45 degree angle into the slot and gently push the SO-DIMM down until it is clipped-in.



45 degree angle insert



Push until it is clipped-in

4. [Reinstall the enclosure](#) when done.

3.2.2 mini-PCIe Module, SIM Card and Antenna Installation

There are mini-PCIe with SIM slots on MezIO™ module and the motherboard.

Please follow the procedures below to install the mini-PCIe module and SIM card, as well as the antenna for wireless communication.

1. [Disassemble the system enclosure.](#)
2. The mini-PCIe and SIM slots are shown in the illustration below.

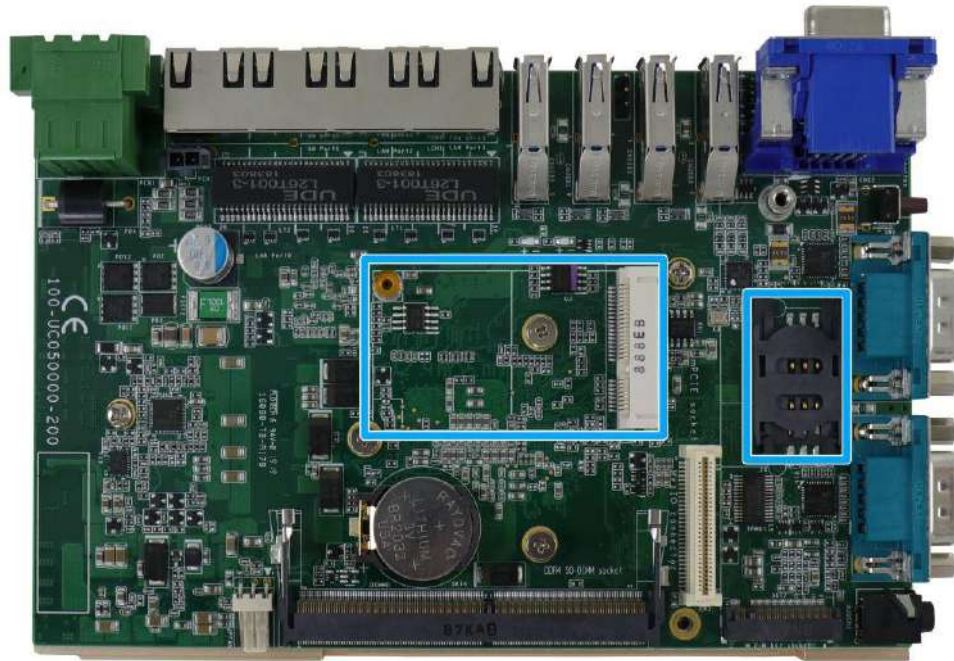

3. **To install**, insert mini-PCIe module's gold finger on a 45 degree angle into the socket, gently press the module down and secure it with a screw.



4. The SIM card slot utilizes a slide-and-clamp mechanism. To open the slot, slide the top section away from the VGA port, flip open the slot and insert the SIM card.

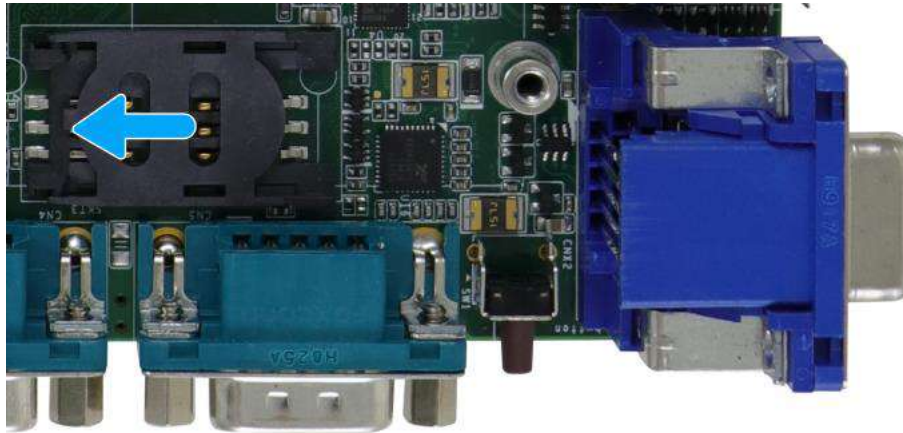

Push away from the VGA port



Flip open the slot and inset SIM card

5. Insert the SIM card into the flipped open section, close, gently press and slide the top section towards the VGA port to secure the SIM card in place.

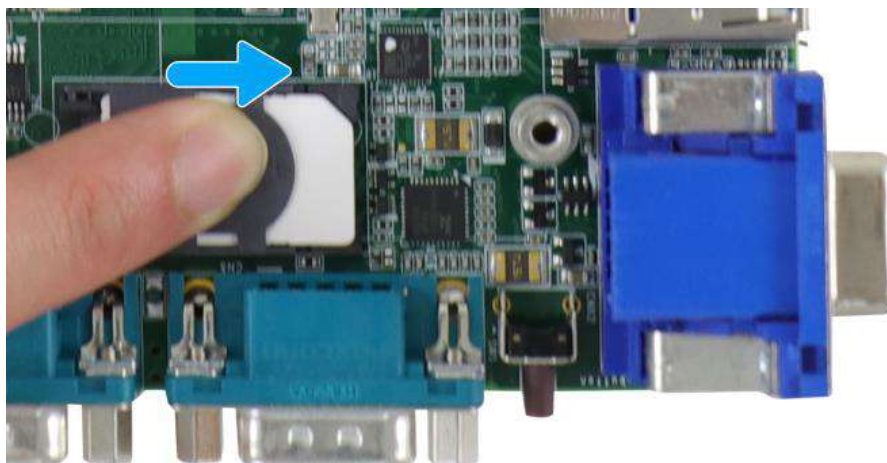

- Clip-on mini-PCIe module's antenna (please refer to the module's user manual on antenna cable connection).

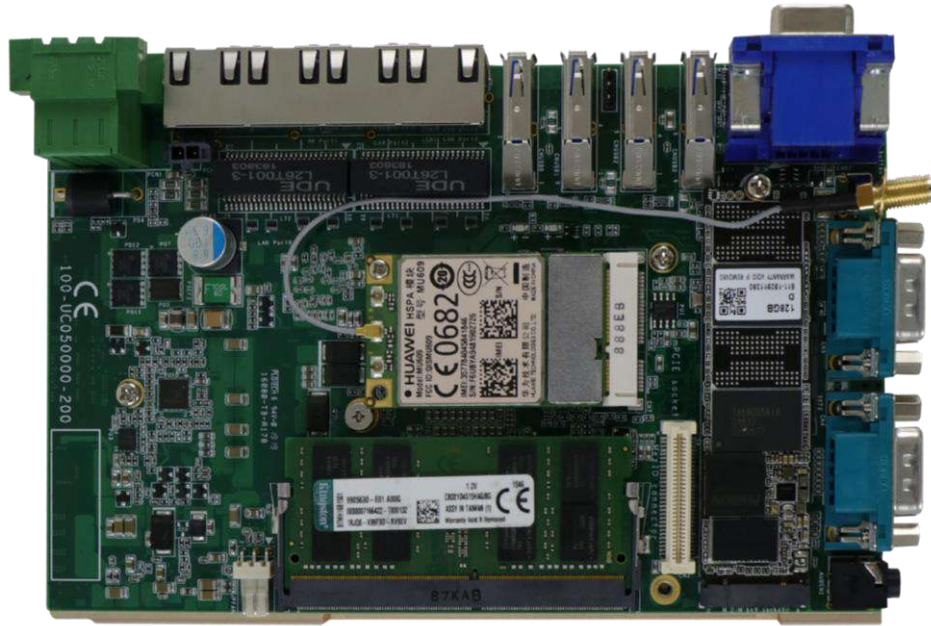

- Remove one of the antenna covers from the enclosure.



- Secure the SMA antenna connector, [reinstall the enclosure](#) and attach the external SMA antenna.

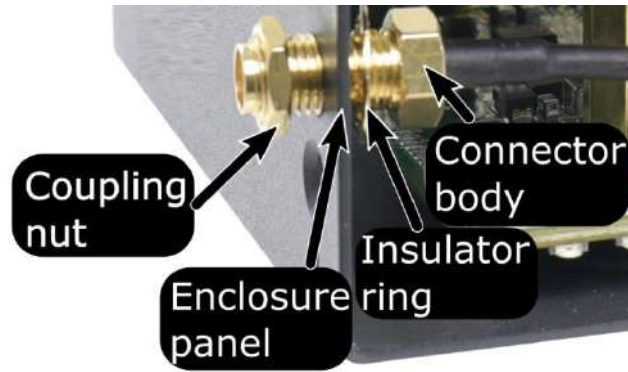

Securing antenna connection



Attach external antenna

- [Reinstall the enclosure](#) when done.

3.2.3 M.2 2280 M Key NVMe SSD Installation

There is one M.2 2280 M Key slot (PCIe Gen3 x2) for you to install an NVMe SSD. Please follow the procedures below to install the M.2 module

1. [Disassemble the system enclosure.](#)
2. Located the M.2 2280 M Key slot once the system enclosure and heat spreader have been removed.

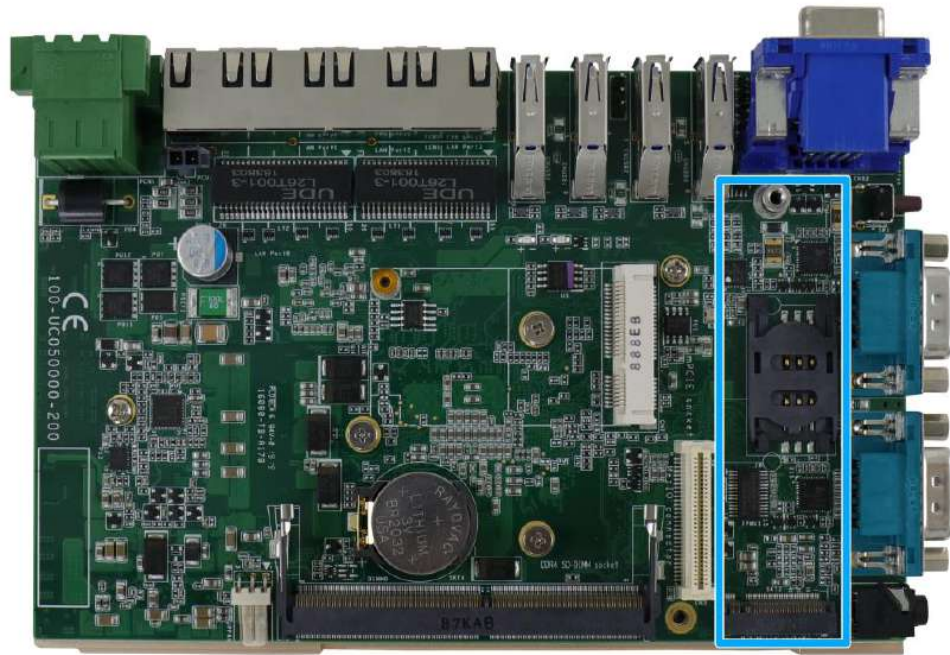

3. Insert the NVMe SSD into the slot on a 45° angle.

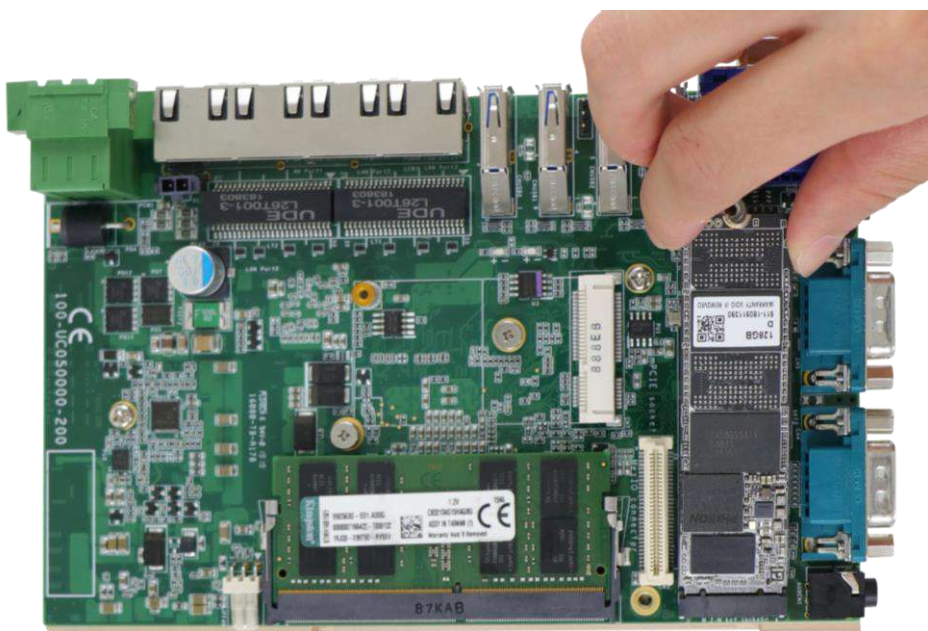

4. Gently push it towards the motherboard and secure the NVMe SSD with the supplied screw.

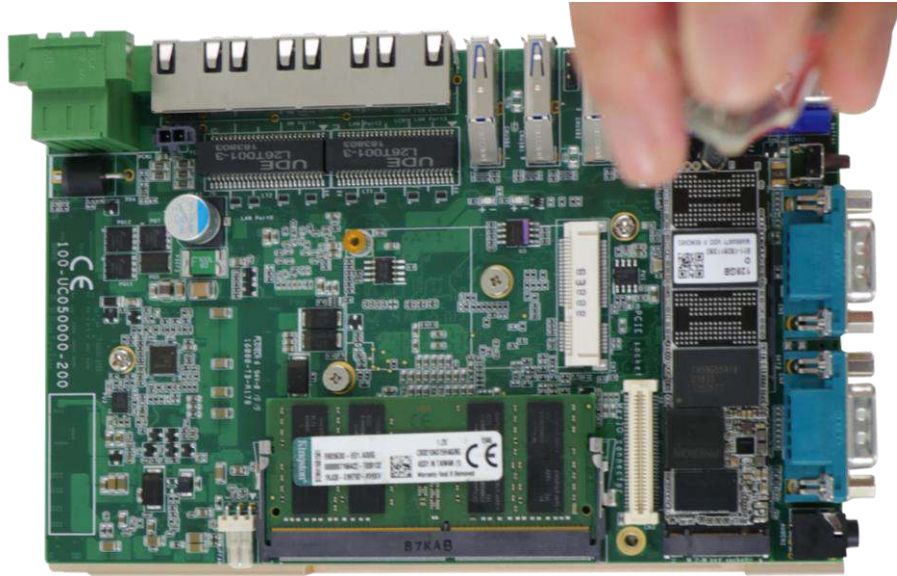

5. Once you have installed the NVMe SSD, you need to reinstall the heat spreader but before you do so, please make sure the protective film on the thermal pads have been removed.

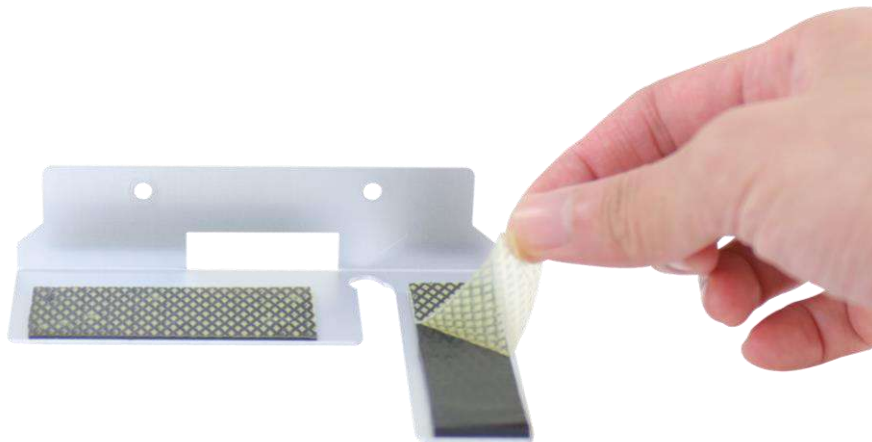

6. Secure the heat spreader by securing the two screws (indicated in red).



7. [Reinstall the enclosure](#) when done.

3.2.4 MezIO™ Module Installation

The MezIO™ module is situated above the heat spreader. Please make sure that you have installed the memory module, mini-PCIe, SIM card, NVMe SSD before installing the MezIO™ module. To install the MezIO™ module, please refer to the following procedure.

1. The MezIO™ module connector can be located on the motherboard.

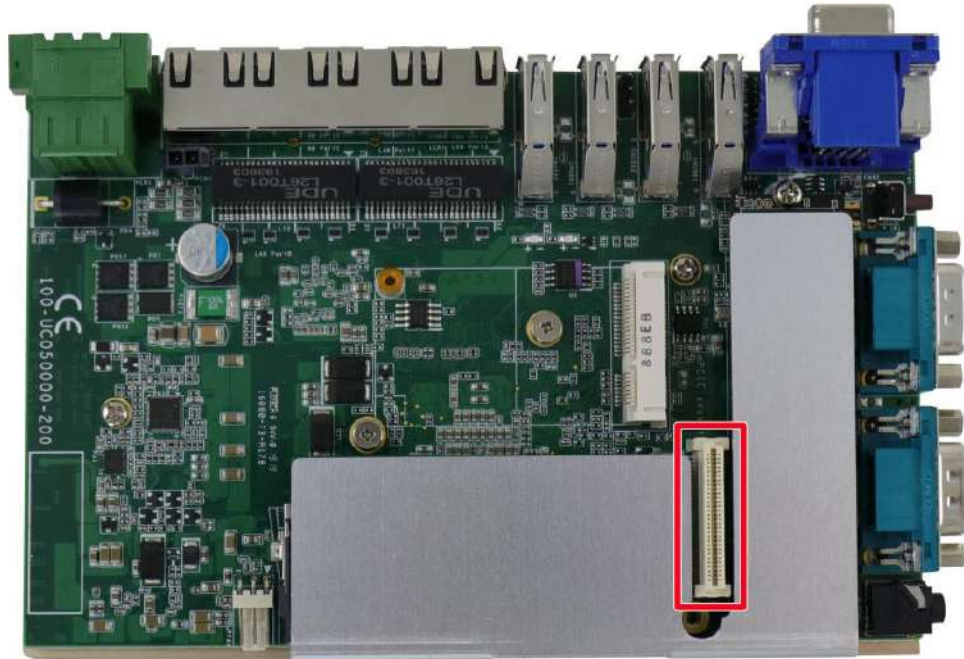

2. Remove the screws indicated in red and replace with stand-off hex bolt screws.

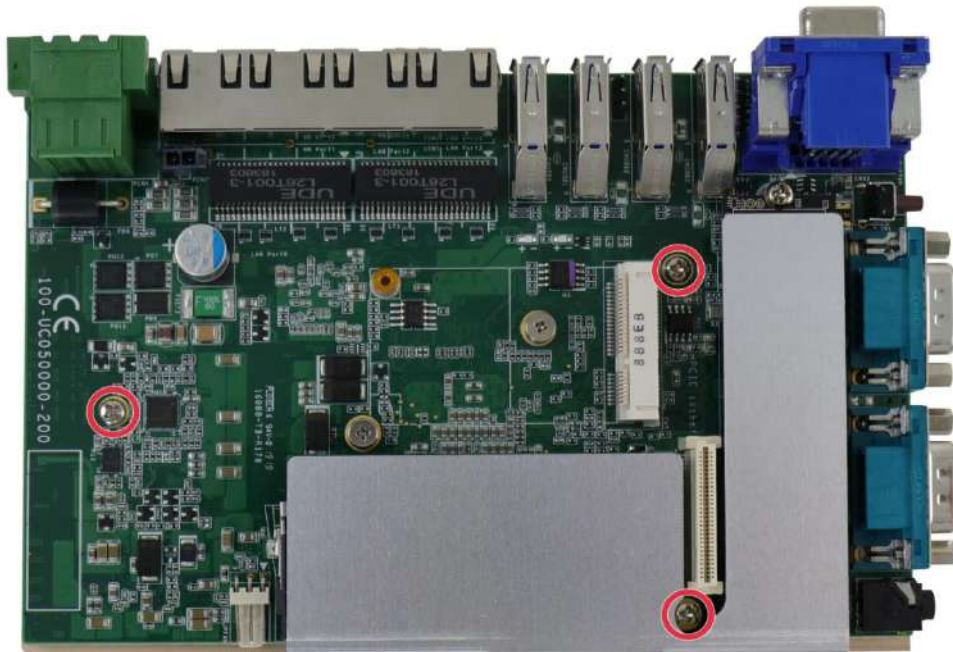

- Secure the stand-off hex bolts that came with the MezIO™ card onto the motherboard. Gently lower the module onto the motherboard. The MezIO™ connector should engage the port if the three (3) standoffs and screw holes meet.

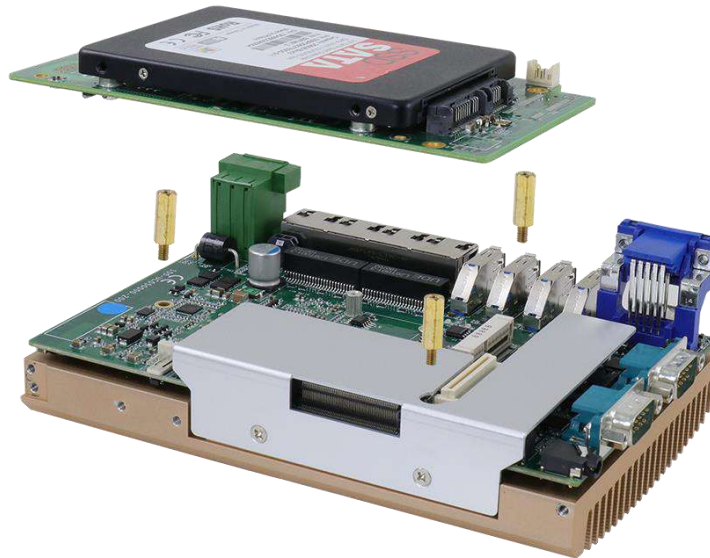

- Then secure the MezIO™ module to the hex bolts with three (3) P-head screws.

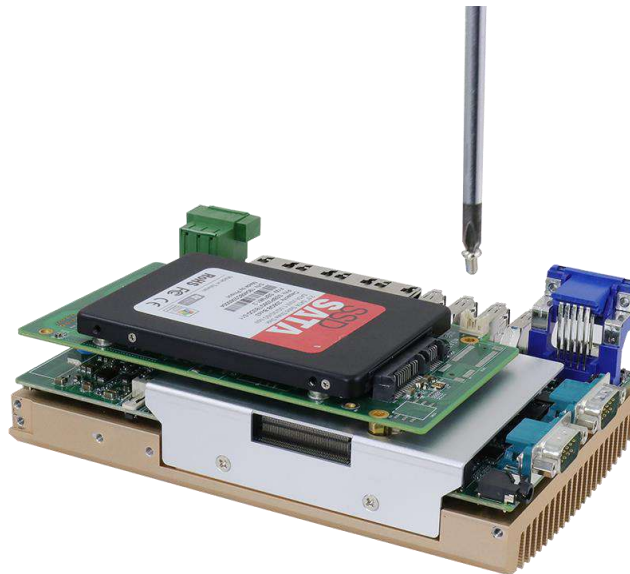

- [Reinstall the system enclosure](#) when done.



NOTE

*When a MezIO-D230 or MezIO-D220 module is installed, the mini PCIe slot can not be used due to mechanical interference.

3.3 Installing the System Enclosure

1. To reinstall the system enclosure, install the DIO port panel and secure it into the lower screw opening (indicated in red).



2. Install the front panel by securing it with three (3) screws (indicated in blue and green) and the two (2) hexa bolt (indicated in red) on the VGA connector. For POC-545/ 546 systems, please place the fan beneath the heatsink and secure it with screws (indicated in green).



POC-515/ POC-516 systems



POC-545/ POC-546 systems

3. Place the L-shaped enclosure panel back into place and secure it with three (3) screws.



10. Secure the two (2) screws (indicated in red) to complete the enclosure assembly for POC-515/ 516 systems. For POC-545/ 546 systems, please secure the fan onto the enclosure.



POC-515/ POC-516 systems



POC-545/ POC-546 systems

11. For POC-545/ 546, plug in the 3-pin fan power connector and secure the power cable cover with screws (indicated in red) to complete the enclosure assembly procedure.

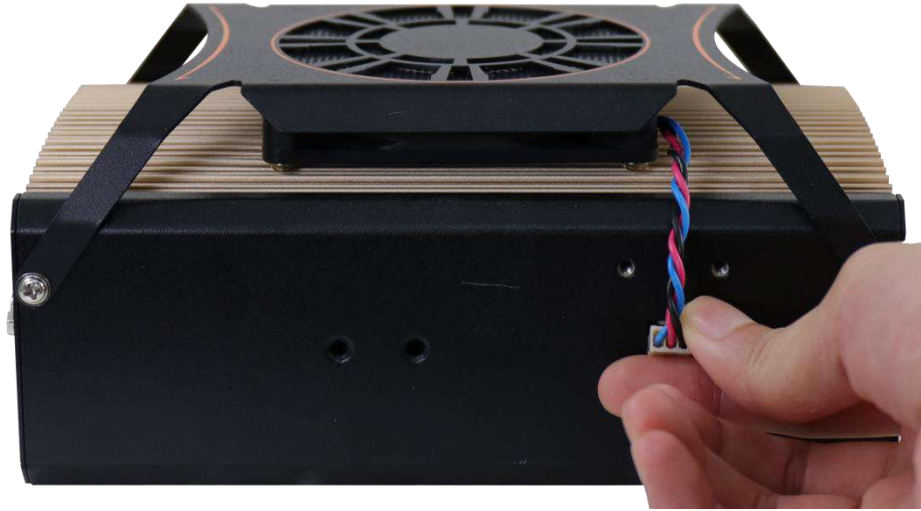

Plug in the 3-pin fan power connector

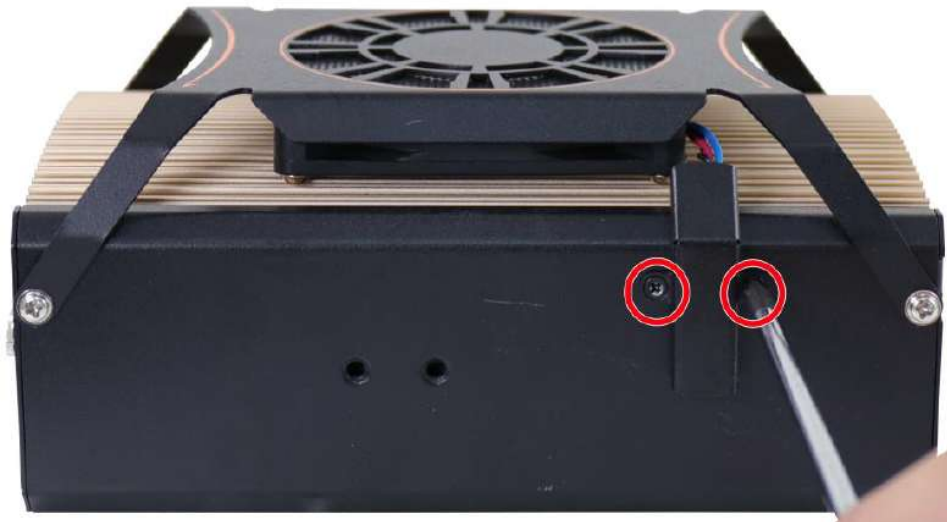

Secure the power cable cover

3.4 DIN Rail Installation

The system comes with a DIN rail clip (in the accessory box) that allows the system to be mounted vertically.

1. To install, secure the DIN rail clip to the rear side panel of the system enclosure using the M4 screws provided.

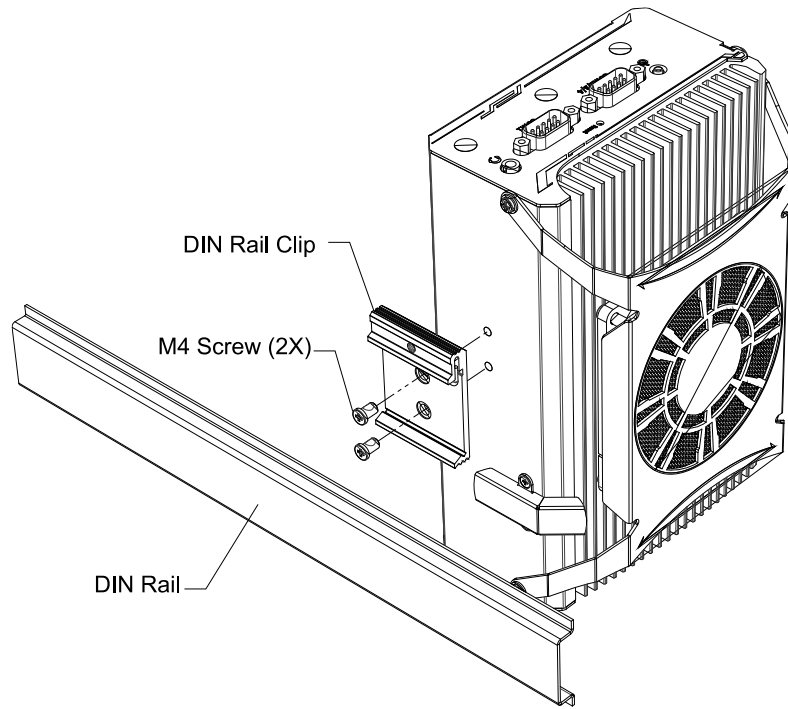

2. To install the DIN rail clip onto the DIN rail, you must come over the top of the DIN rail, tilting, overlap the top clip edge of the DIN rail clip onto the DIN rail first, and then firmly press the bottom-front of the enclosure to clip the bottom edge of the mount plate.

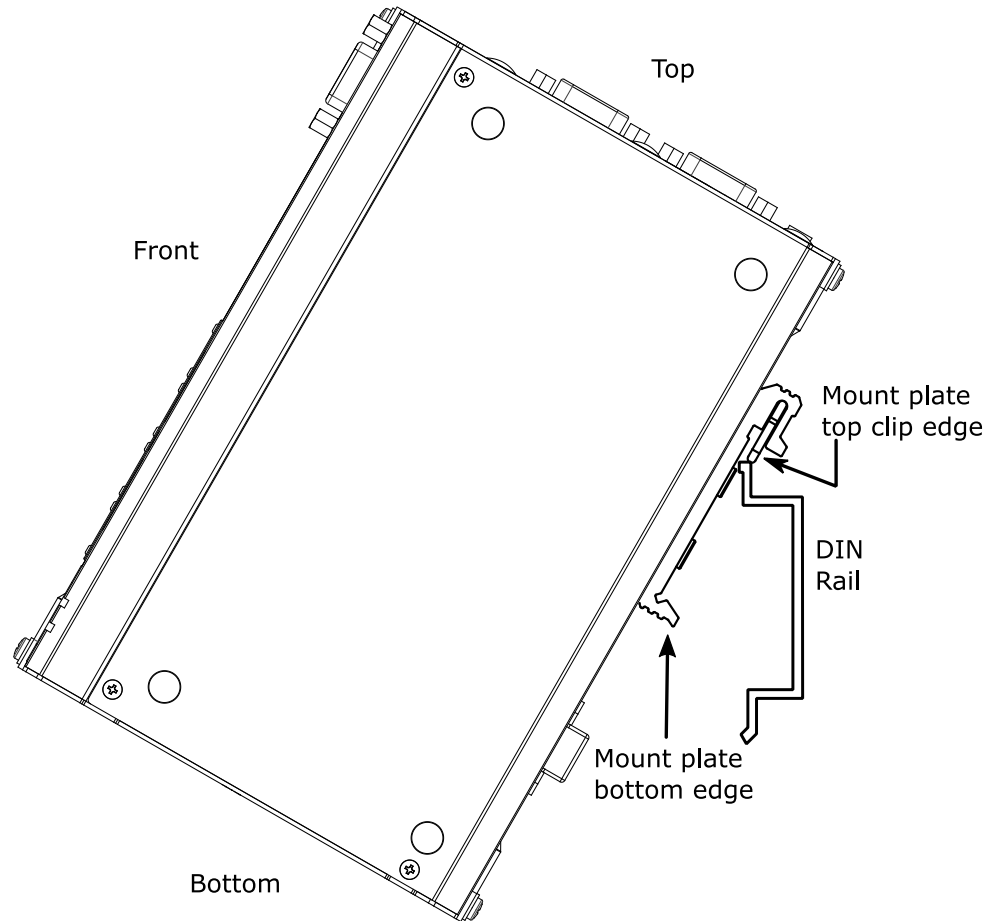

3. Confirm the mount plate has indeed clipped onto the DIN rail for proper fit to complete the installation.

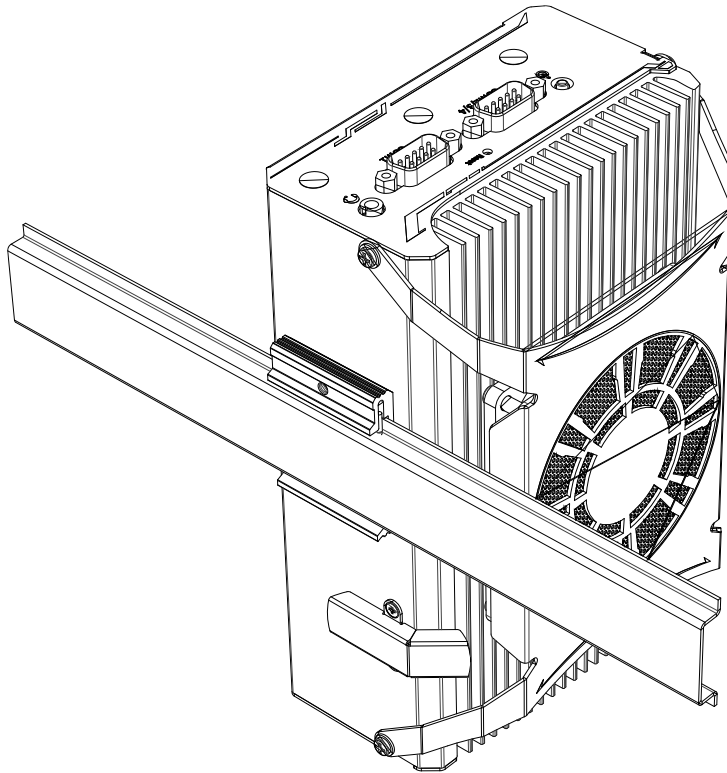

3.5 Wall Mount Installation (Optional)

The optional wall mount bracket allows the system to be mounted horizontally.

Please refer to the following installation procedure to install the wall mount.

1. To install, secure the wall mount bracket to the bottom of the system enclosure using the M4 screws provided.

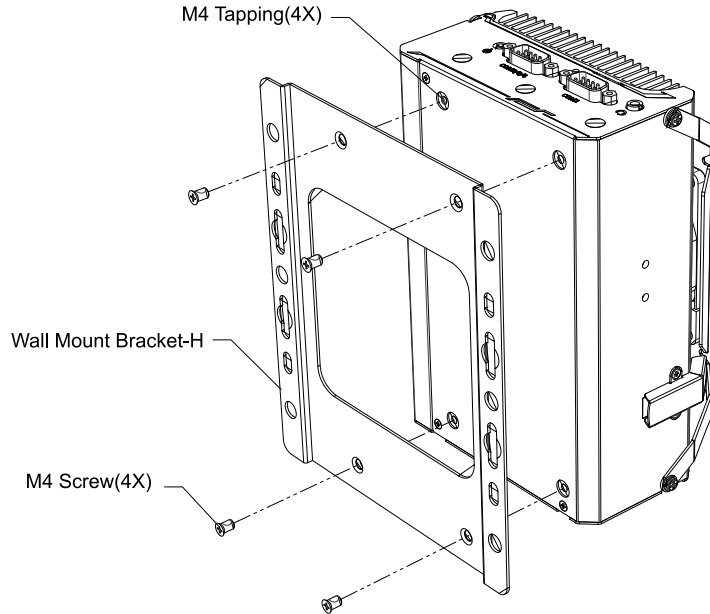

2. Dimension illustration of the installed wall mount bracket for your reference.

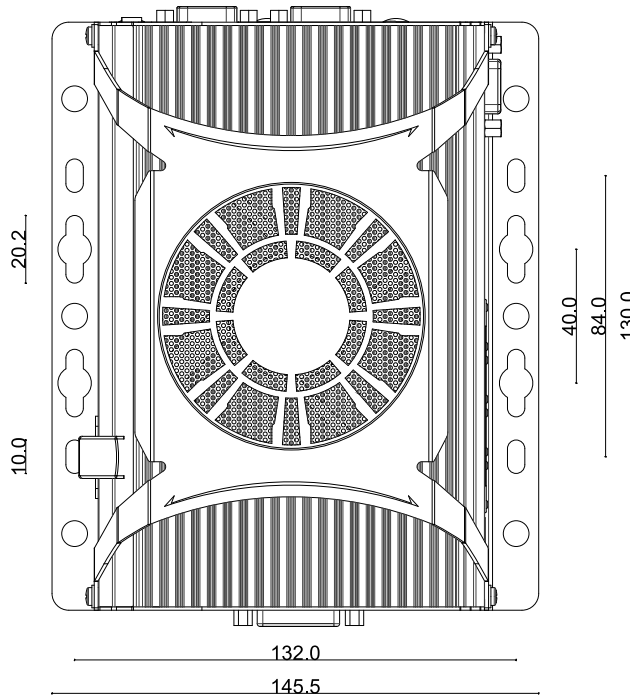

3.5.1 Vertical Wall Mount Bracket (Optional)

- To install, secure the wall mount bracket to the rear side panel of the system enclosure using the M4 screws provided.

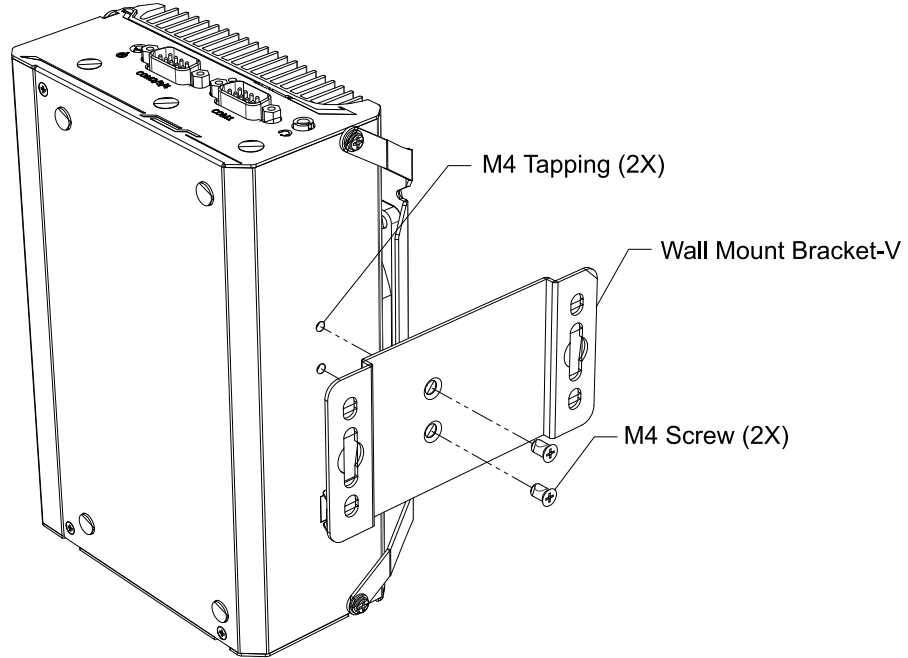

- Dimension illustration of the install vertical wall mount bracket for your reference.

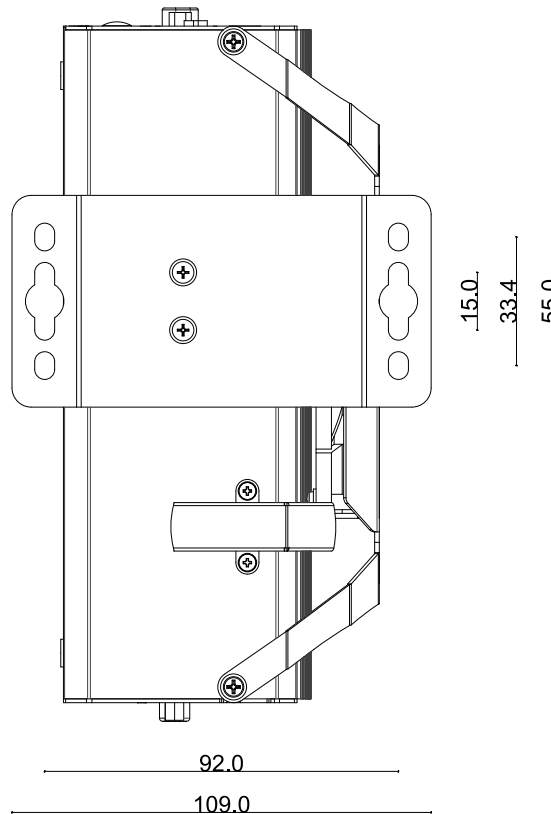

3.6 Powering On the System

There are three methods to power on the system

- [Pressing the power button](#)
- [Via an external non-latched switch](#)
- [Sending a LAN packet via Ethernet \(Wake-on-LAN\)](#)

3.6.1 Powering On Using the Power Button

This is the simplest way to turn on your system. The power button on the side panel is a non-latched switch and behaves as the ATX-mode on/off control. With DC power connected, pushing the power button will turn on the system and the PWR LED indicator will light up. Pushing the button when system is on will turn off the system. If your operating system supports ATX power mode (i.e. Microsoft Windows or Linux), pushing the power button while the system is in operation will result in a pre-defined system behavior, such as shutdown or hibernation.

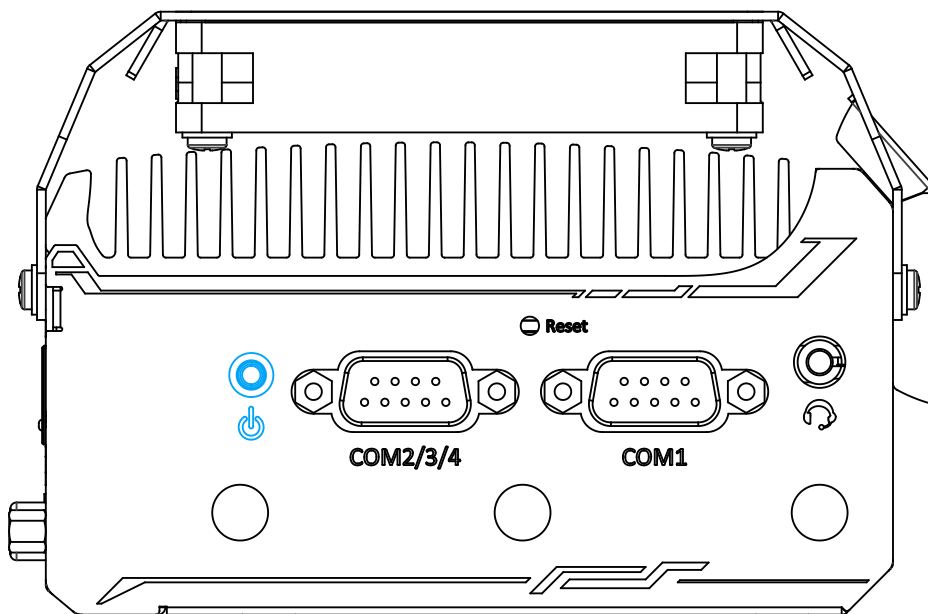

3.6.2 Powering On Using An External Non-Latched Switch

If your application demands the system to be placed inside a cabinet, you may use an external non-latched switch to power on/ off the system. The system provides a 3-pin “Remote On/ Off” plug for connecting a non-latched switch and acts as the ATX-mode power on/off control switch. The external non-latched switch acts exactly the same as the power button on the side panel. To setup and power on/ off the system using an external non-latched switch (ATX-mode), please follow the steps described below.

1. Acquire a non-latched switch with 3-pin plug.
2. Connect the non-latched switch to the Remote On/ Off plug.

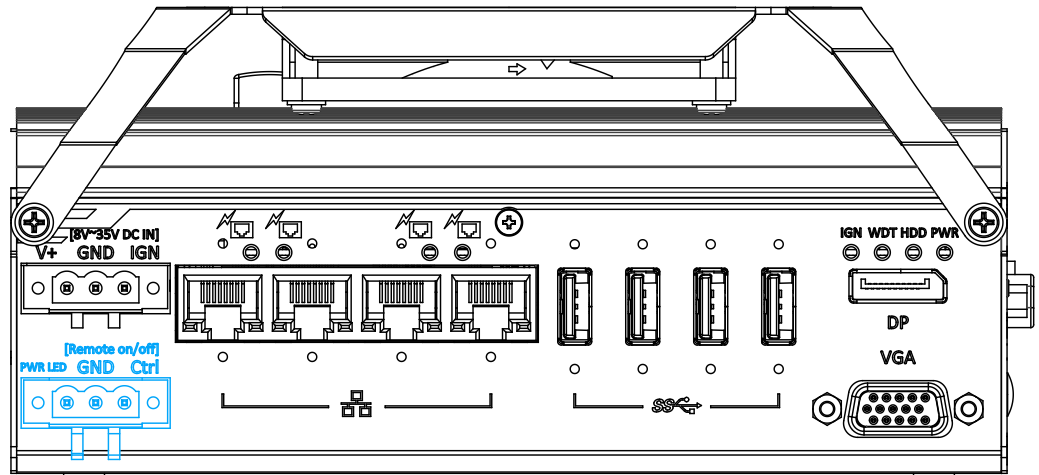

3. With DC power connected, pushing the power button will turn on the system and the PWR LED indicator will light up. Pushing the button when system is on will turn off the system. If your operating system supports ATX power mode (i.e. Microsoft Windows or Linux), pushing the power button while the system is in operation will result in a pre-defined system behavior, such as shutdown or hibernation.

3.6.3 Powering On Using Wake-on-LAN

Wake-on-LAN (WOL) is a mechanism to wake up a computer system from a S3 (standby), S4 (Hibernate) or S5 (system off with standby power) state via issuing Subnet Directed Broadcasts (SDB) or a magic packet. The system implements the Wake-on-LAN function for the GbE ports highlighted in blue, shown below.

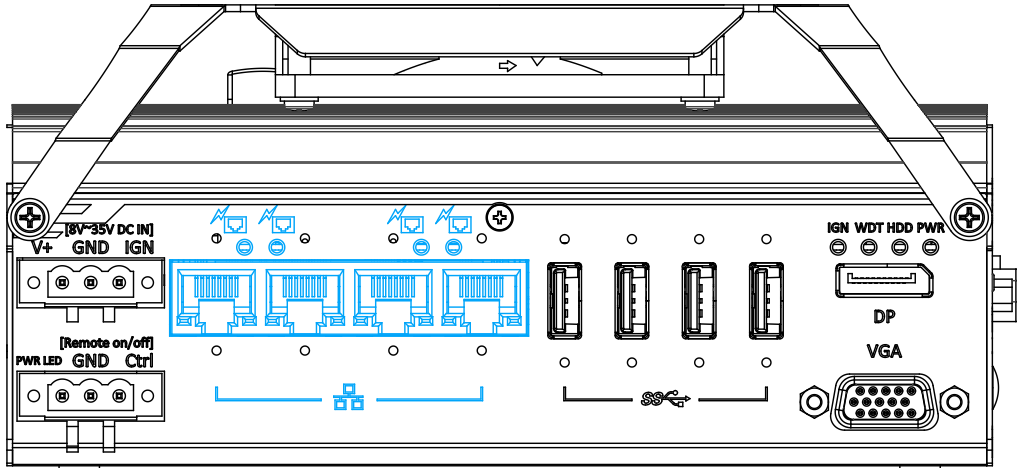

To enable WOL function and power on your system, please follow the steps below.

1. Press F2 when the system boots up to enter BIOS.
2. Enter the **[Power]** menu. And configure the **[Wake On LAN]** option as **[Enabled]**. Please refer to the [Wake-on-LAN](#) section.
3. In Windows systems, identify the Local Area Connection of the corresponding Gigabit Controller and click the **Configure** button.

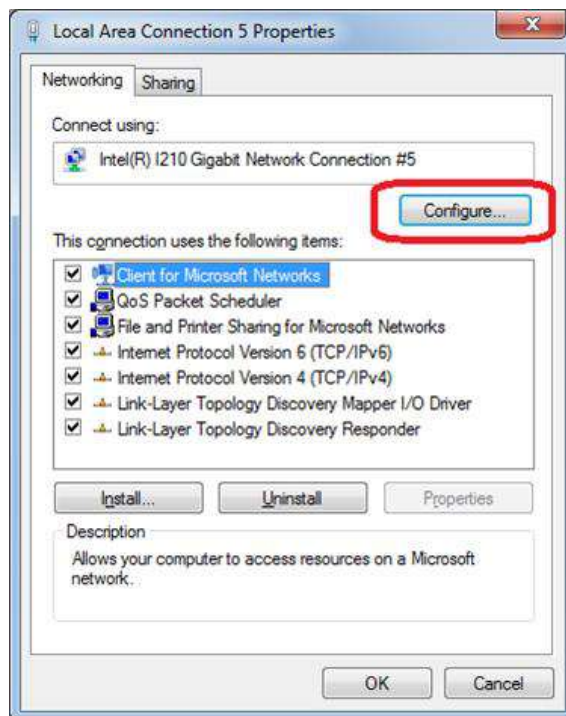

4. Click the **Power Management** tag, and check the following two options accordingly

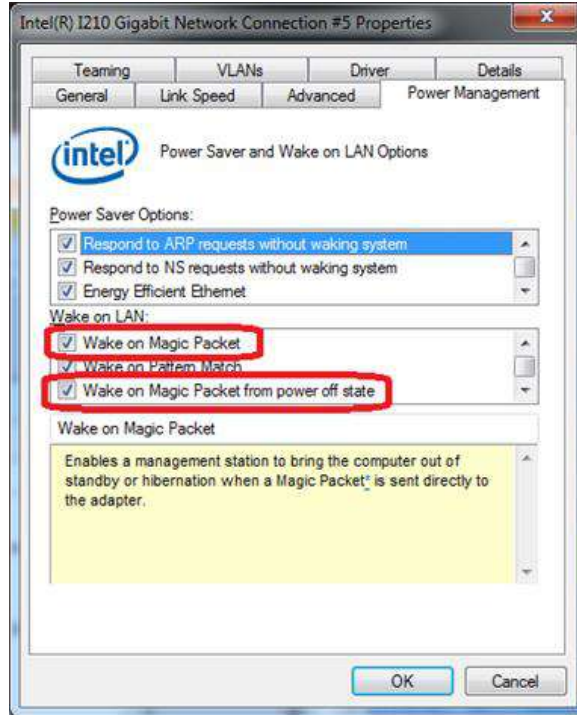

- **Wake on Magic Packet**

The system can wake from S3 or S4 state when receiving a magic packet. The magic packet is a broadcast frame containing anywhere within its payload 6 bytes of all 255 (FF FF FF FF FF FF in hexadecimal), followed by sixteen repetitions of the target computer's 48-bit MAC address.

For example, NIC's 48-bit MAC Address is 78h D0h 04h 0Ah 0Bh 0Ch

DESTINATION SOURCE MISC

FF FF FF FF FF FF

78 D0 04 0A 0B 0C 78 D0 04 0A 0B 0C

78 D0 04 0A 0B 0C 78 D0 04 0A 0B 0C

78 D0 04 0A 0B 0C 78 D0 04 0A 0B 0C

78 D0 04 0A 0B 0C 78 D0 04 0A 0B 0C

78 D0 04 0A 0B 0C 78 D0 04 0A 0B 0C

78 D0 04 0A 0B 0C 78 D0 04 0A 0B 0C

78 D0 04 0A 0B 0C 78 D0 04 0A 0B 0C

78 D0 04 0A 0B 0C 78 D0 04 0A 0B 0C

MISC CRC

There are some free tools available on Internet that can be used to send a magic packet. Please refer to the following link to understand more about Magic Packet.

<http://en.wikipedia.org/wiki/Wake-on-LAN>

- **Wake on Magic Packet from power off state**

When checking this option, the system can wake from S5 (system off with standby power) state when receiving a magic packet.

4 BIOS Settings

The system is shipped with factory-default BIOS settings optimized for best performance and compatibility. In this section, we'll illustrate some BIOS settings you may need to set or change prior to operating system installation. Please always make sure you understand the effect of change before you proceed with any changes. If you are unsure of the function you are changing, it is recommended to change one setting at a time to see its effect(s).

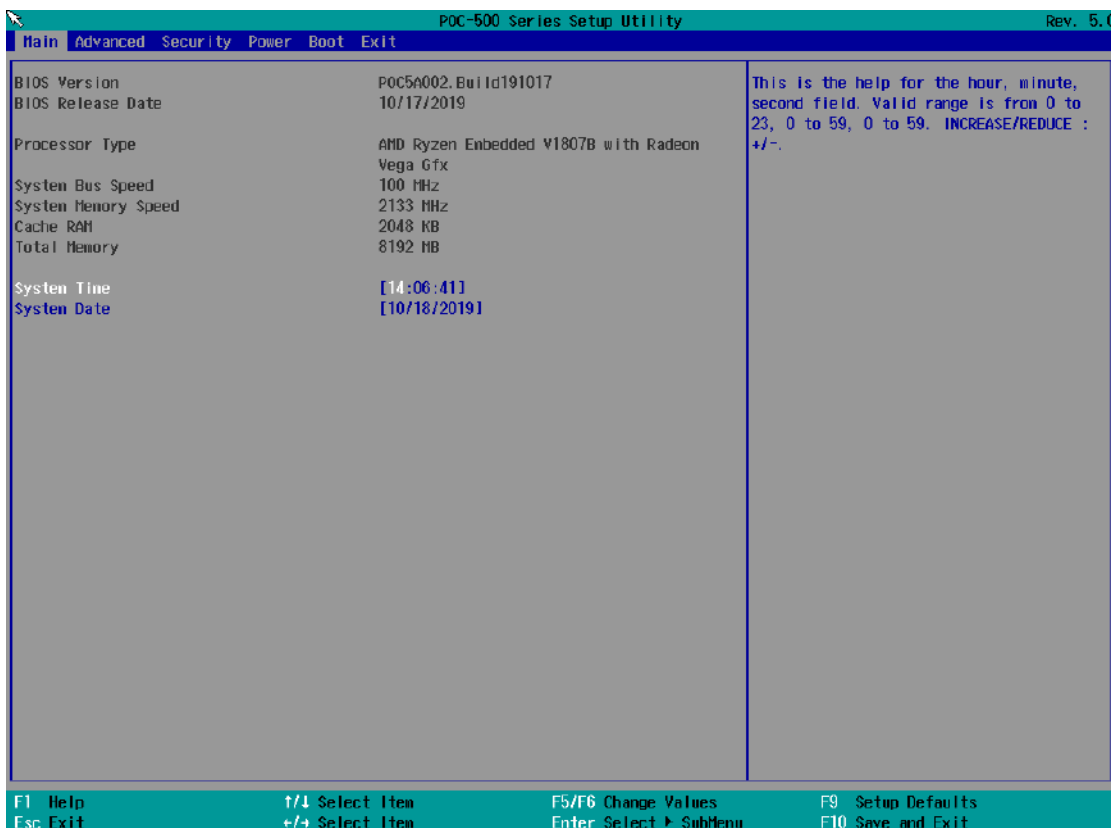

 **NOTE**

Not all BIOS settings will be discussed in this section. If a particular setting/ function you are after requires specific BIOS settings but is not discussed in this section, please contact Neousys Technical Support staff.

4.1 COM1/ 2 Port Configuration

The system's [COM1/ 2](#) ports support RS-232 (full-duplex), RS-422 (full-duplex) and RS-485 (half-duplex) mode. You can set the COM1/ 2 operating mode via BIOS settings. The option in the BIOS setting called “Slew Rate” defines how sharp the rising/falling edge is for the output signal of COM1/ 2. For long-distance RS-422/485 transmission, you may set the “Slew Rate” option as “High” to improve signal quality. For RS-422/485 communication, the “RS-422/485 Termination” option determines whether to enable/disable internal termination of RS-422/485 transceiver according to your wiring configuration (e.g. with or without external termination).

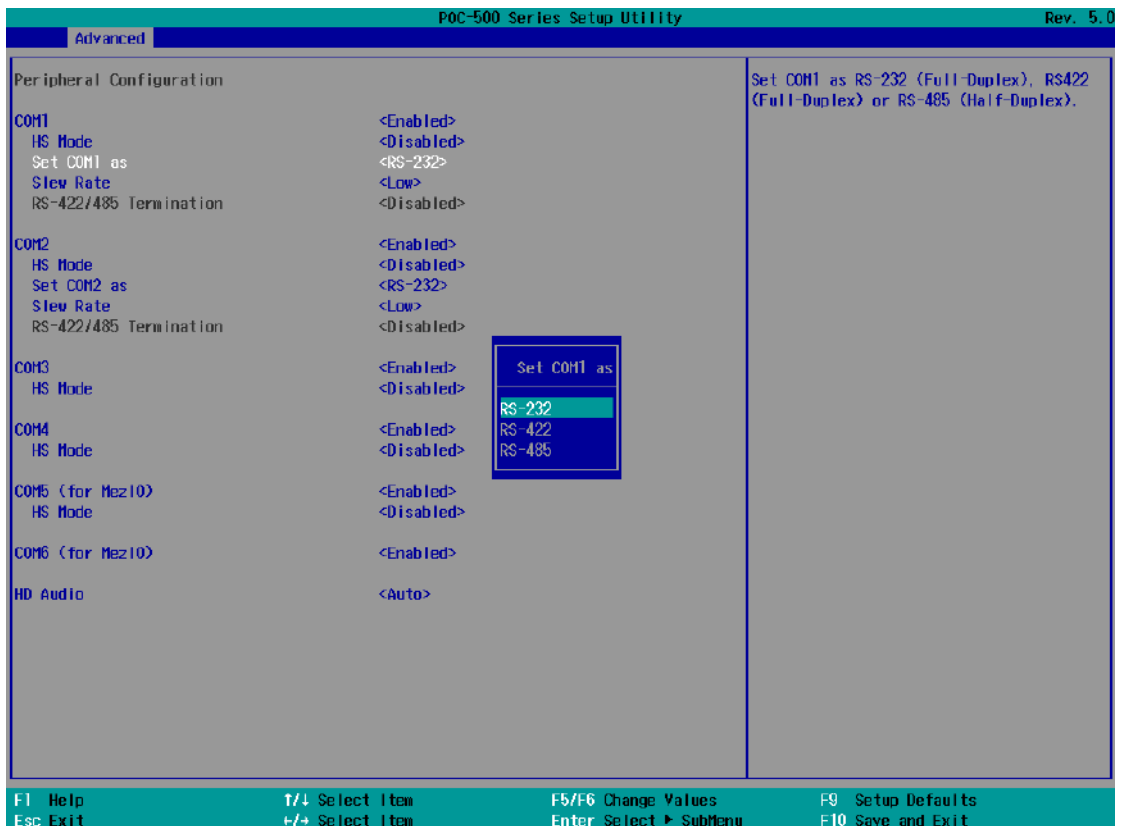

To set COM1 operating mode:

1. Press **F2** when the system boots up to enter the BIOS setup utility.
2. Go to **[Advanced] → [Peripheral Configuration]**.
3. Set the **[Set COM1 Mode as]** option to the desired mode.
4. Once set, press **F10** to save setting and exit.

4.2 COM 3/ 4 Port Configuration

The system's [COM 3/ 4](#) ports support RS-232 (full-duplex) and to enable it, COM 2 must be set to RS-232 mode. Another option in COM port's BIOS setting is called HS (High Speed) and when enabled, the input clock for baud rate generator is multiply by 8. The maximum baud rate would reach up to 921,600 bps.

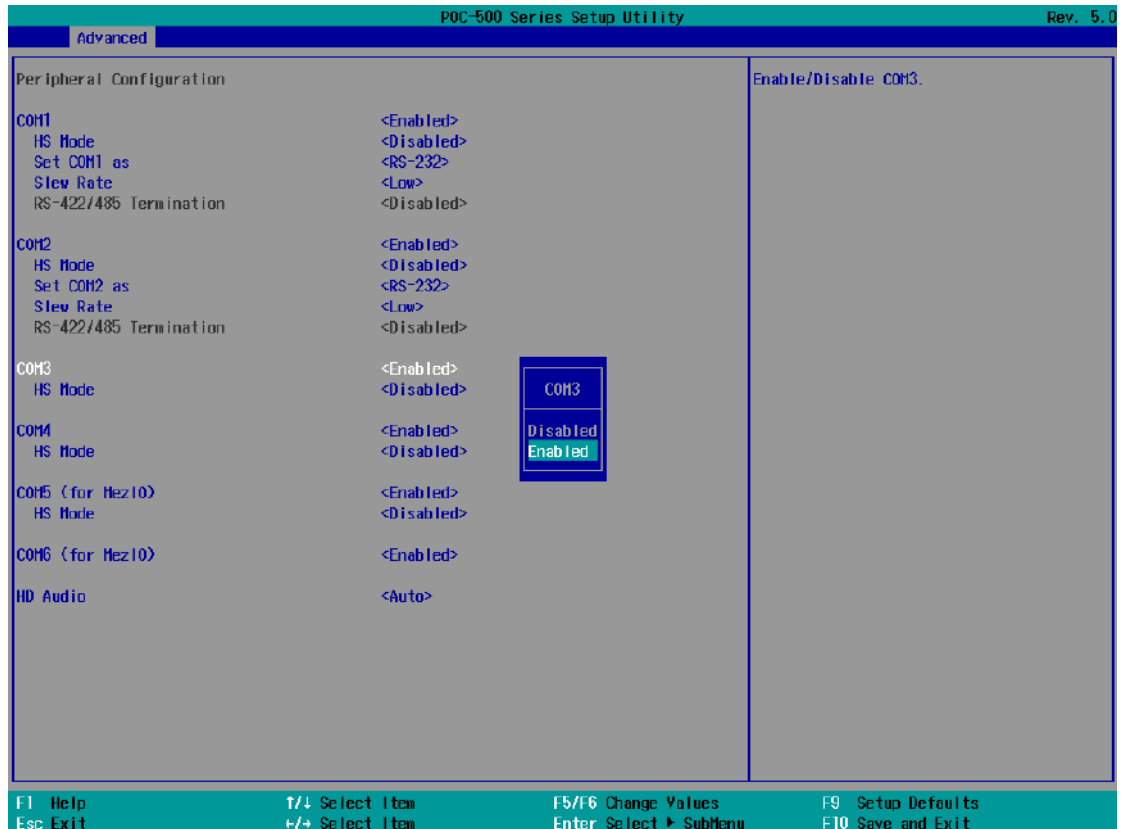

To enable COM/ 3/ 4 operating mode:

1. Press **F2** when the system boots up to enter the BIOS setup utility.
2. Go to **[Advanced]** → **[Peripheral Configuration]**.
3. Highlight the COM port (3 or 4) and set it to <Enabled> .
4. Once set, press **F10** to save setting and exit.

4.3 COM Port High Speed Mode

The high speed mode of each COM port effectively allows for the port's baud rate generator to operate at 8x the speed with an effective baud rate of 921,600 bps (115,200 x 8). Please refer to the following instructions on how to enable the high speed mode for your COM port (COM1 used as an example).



To set COM port high speed mode:

1. Press **F2** when the system boots up to enter the BIOS setup utility.
2. Go to **[Advanced] > [Peripheral Configuration]**.
3. Enable or set the **[Set COM1 Mode as]** option to the desired mode.
4. Highlight **[HS Mode]** and press ENTER to bring up options, highlight **[Enable]** and press ENTER.
5. Once set, press **F10** to save setting and exit.

4.4 SATA Configuration for MezIO™ Module

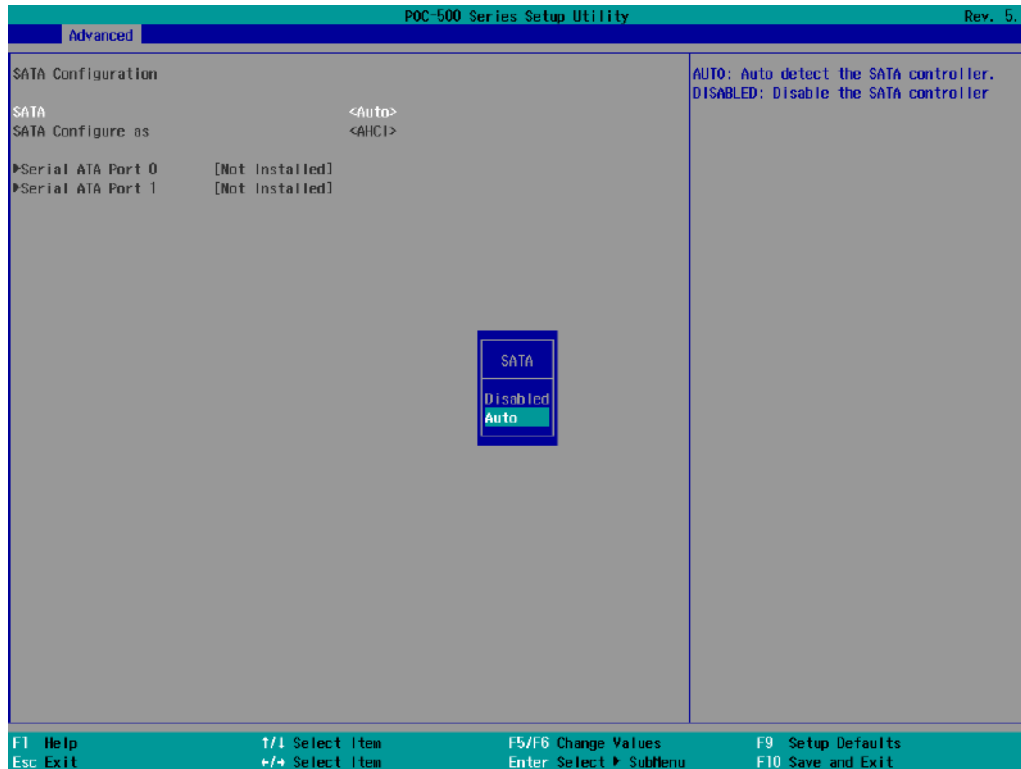

The SATA configuration setting should be configured according to the MezIO™ card installed. For detail settings, please refer to the following table.

Module & description	MezIO™ module	Description
SATA set to <Auto>	MezIO-R11	1x 2.5" SATA HDD/ SSD
	MezIO-R12	1x 2.5" SATA HDD/ SSD + 4-CH isolated DI and 4-CH isolated DO
SATA set to <Disabled>	MezIO-U4-50	4x USB 3.1 Gen1 ports
	MezIO-G4	4x GigE ports by 4x Intel® I210 controllers, supporting 9.5 kB jumbo frame



NOTE

For other MezIO™ modules, both Auto/ Disabled configurations are compatible.

To enable/ disable SATA configuration:

1. Press **F2** when the system boots up to enter the BIOS setup utility.
2. Go to **[Advanced] > [SATA Configuration]**, press Enter to bring up options, Disabled/ Auto.
3. Highlight your selection and press Enter and press F10 to "Exit Saving Changes".

4.5 TPM Availability

Trusted Platform Module (TPM) is a hardware-based cryptoprocessor to secure hardware by integrating cryptographic keys into devices. The system is designed with on-board TPM 2.0 module. It is enabled in the BIOS by default.

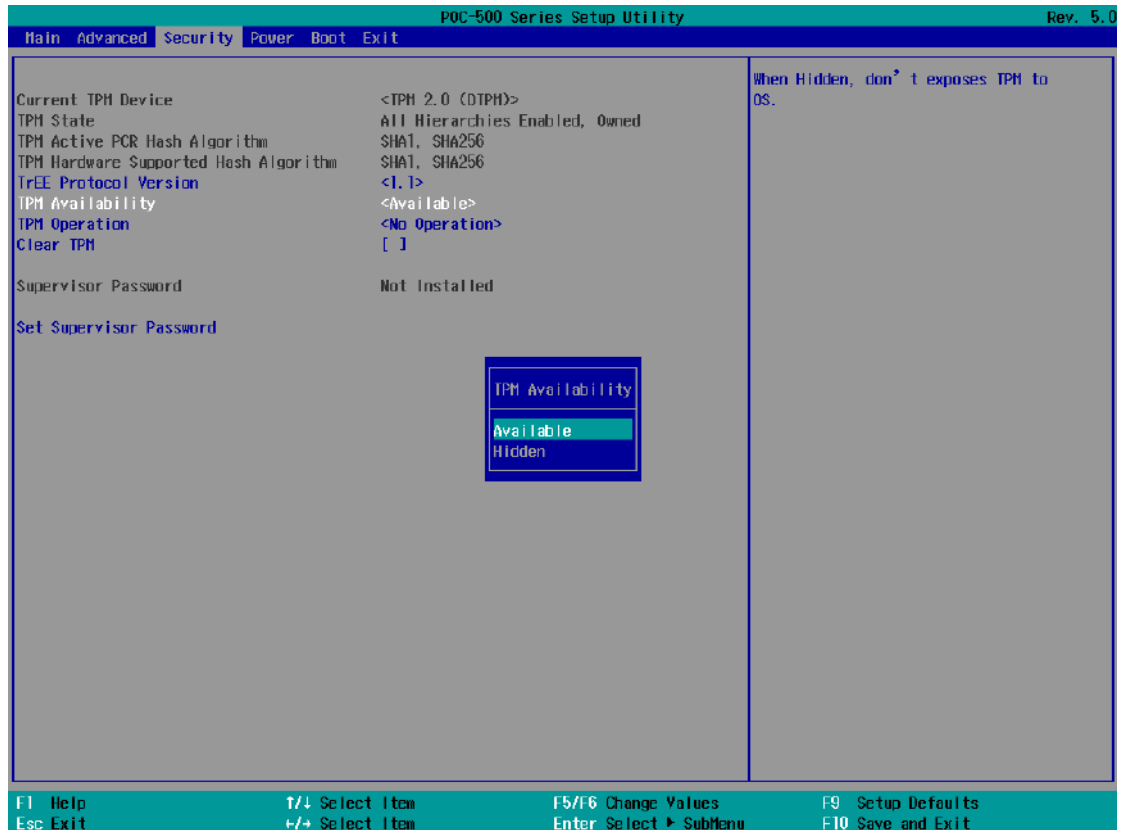

To enable TPM availability:

1. When system boots up, press F2 to enter BIOS setup utility.
2. Go to **[Security] > [TPM Availability]**, press ENTER to bring up Options, Available/ Hidden.
3. Highlight your selection, press Enter and press F10 to “Exit Saving Changes”.

4.6 System Power Configuration (POC-515/ 516)

The system power configuration allows you to set the maximum power consumption of the system. Depending on your application, you can configure the option to 25W for higher performance or 12W for lower power-consumption. You may also leave the setting on Auto and allow the system to auto regulate power consumption according to application needs.

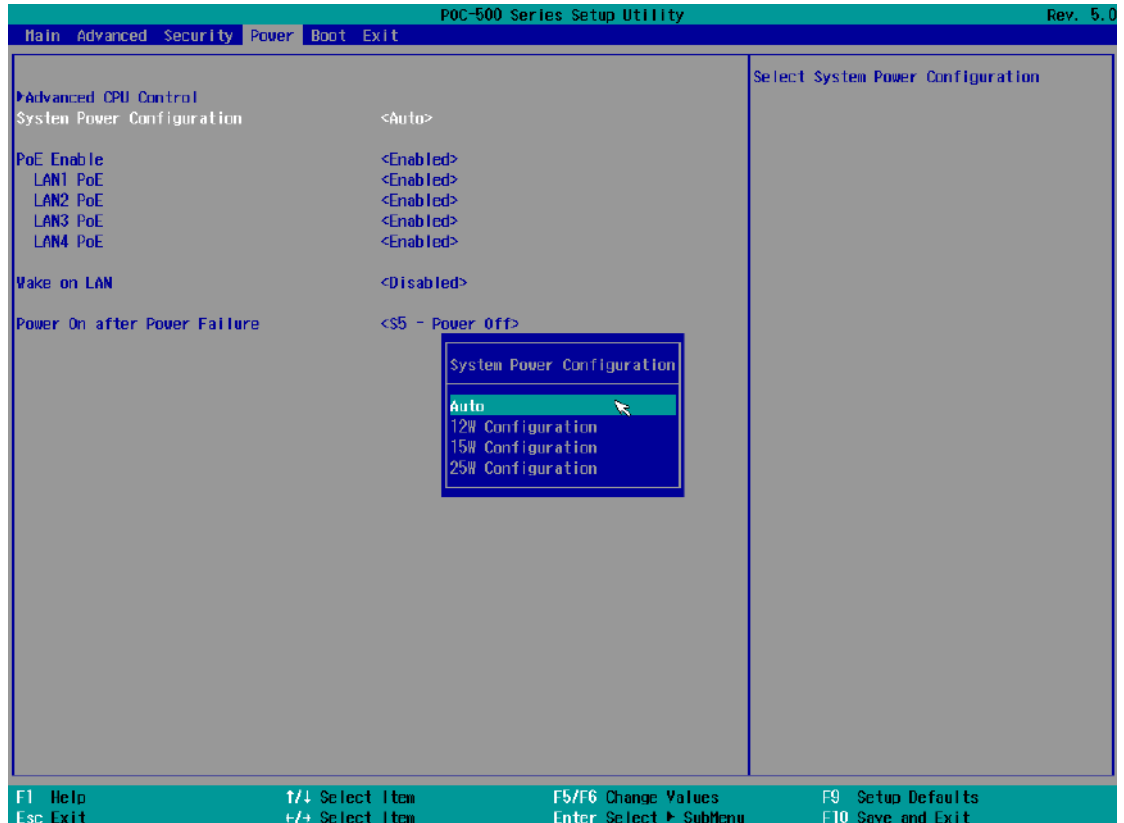

To set System Power Consumption settings:

1. Press **F2** when the system boots up to enter the BIOS setup utility.
2. Go to **[Power]** → **[System Power Configuration]**
3. Use the up/ down arrow to highlight and select between Auto/ 12W/ 15W/ 25W Configuration.
4. With your option highlighted, press Enter to select.
5. Once set, press **F10** to save setting and exit.

4.7 System Power Configuration (POC-545/ 546)

The system power configuration allows you to set the maximum power consumption of the system. Depending on your application, you can configure the option to 54W for higher performance or 35W for lower power-consumption. You may also leave the setting on Auto and allow the system to auto regulate power consumption according to application needs.

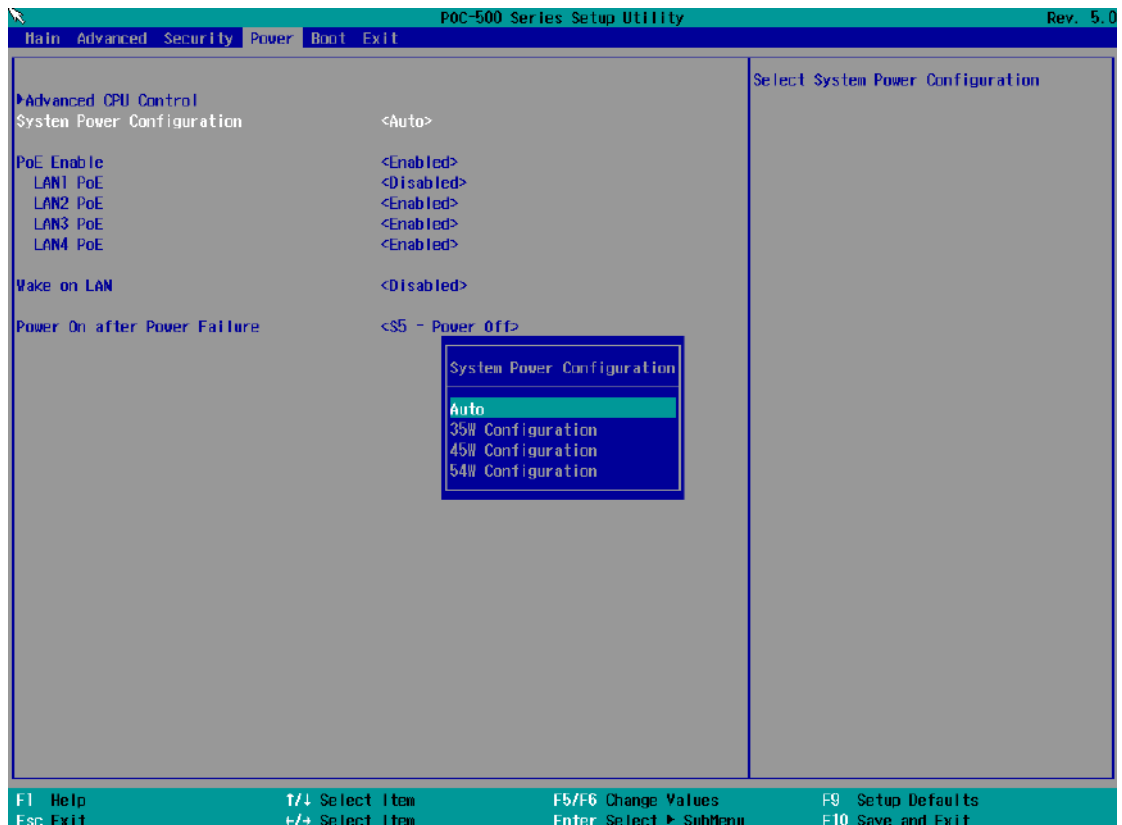

To set System Power Consumption settings:

1. Press **F2** when the system boots up to enter the BIOS setup utility.
2. Go to **[Power]** → **[System Power Configuration]**
3. Use the up/ down arrow to highlight and select between Auto/ 35W/ 45W/ 54W Configuration.
4. With your option highlighted, press Enter to select.
5. Once set, press **F10** to save setting and exit.

4.8 Power over Ethernet (PoE)

The Power over Ethernet (PoE) setting in the BIOS allows you to enable/ disable the PoE function of the designated port upon system boot up.

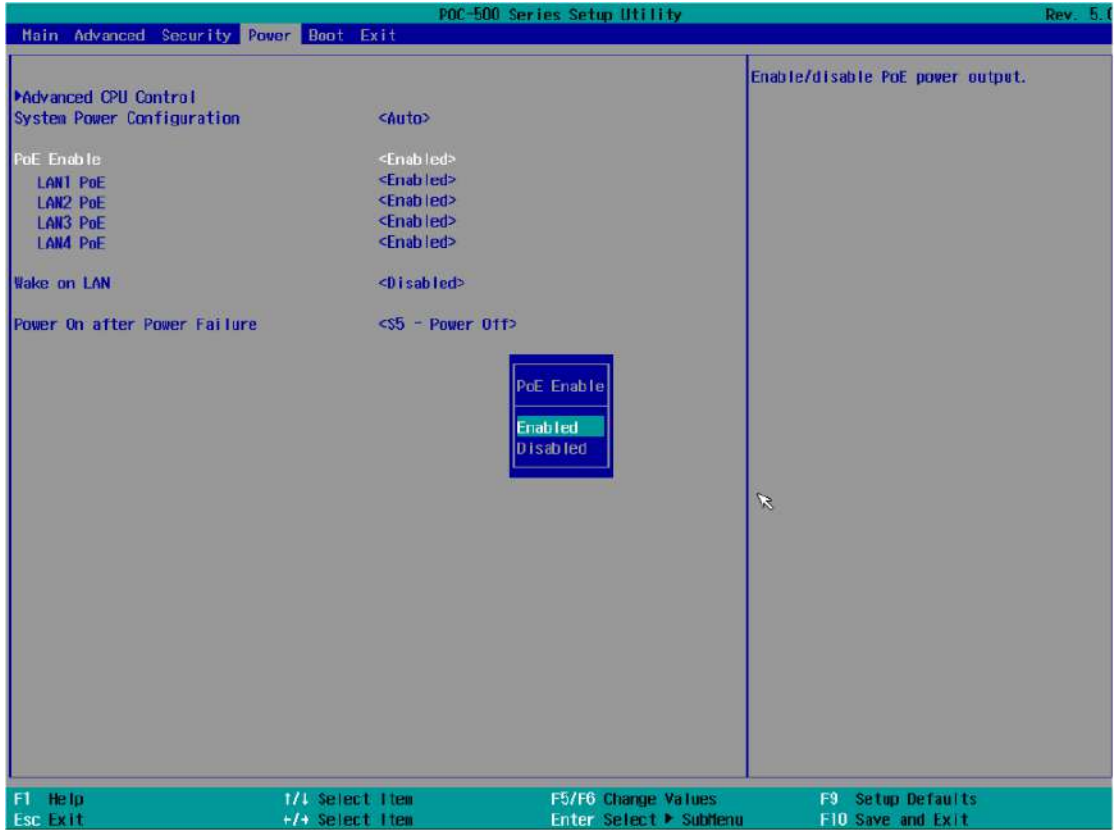

To enable/ disable Power over Ethernet settings:

1. Press **F2** when the system boots up to enter the BIOS setup utility.
2. Go to **[Power]** → **[PoE Enable]**
3. Use the up/ down arrow to highlight and select between Enabled/ Disabled, press Enter to make your selection.
4. When Enabled, you may set each LAN port's PoE function by selecting Enabled/ Disabled using the arrow key, press Enter to make your selection.

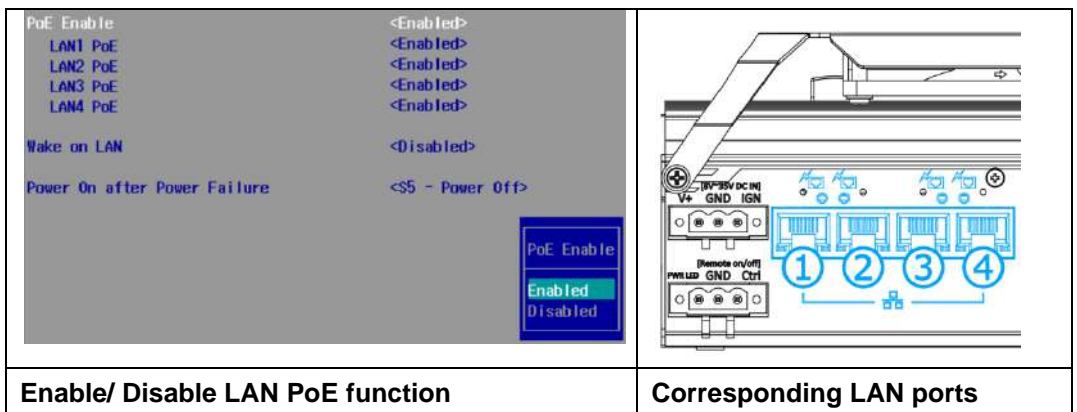

5. Once set, press F10 to save setting and exit.

4.9 Wake-on-LAN

Wake-on-LAN (WOL) is a mechanism which allows you to turn on your system via Ethernet connection. To utilize Wake-on-LAN function, you have to enable this option first in BIOS settings. Please refer to Powering on via Wake-on-LAN function.



To enable/ disable “Wake on LAN” option:

1. Press **F2** when the system boots up to enter the BIOS setup utility.
2. Go to [**Power**].
3. You may enable/disable the [**Wake on LAN**] option.
4. Once set, press **F10** to save setting and exit.

4.10 Power On after Power Failure

This option defines the system's behavior when DC power is supplied.

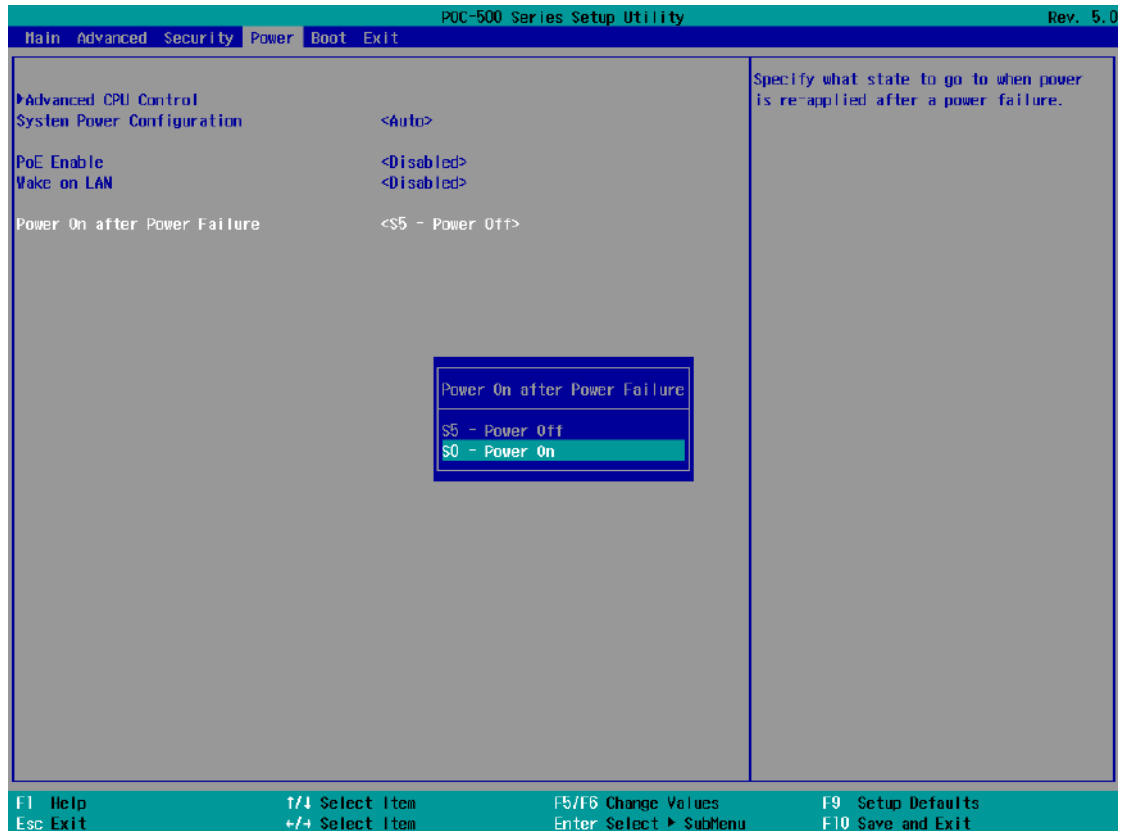

Value	Description
S0 – Power On	System is powered on when DC power is supplied.
S5 – Power Off	System is kept in off state when DC power is supplied.

When you want to use the AT-mode remote on/ off control function, you have to set this option to “S0 – Power On”. Please refer to the section [“Powering on the System”](#) for instructions of using AT-mode remote on/off control function.

To set “Power On after Power Failure” option:

1. Press **F2** when the system boots up to enter the BIOS setup utility.
2. Go to **[Power]**.
3. Set the **[Power On after Power Failure]** option to the desired setting.
4. Once set, press **F10** to save setting and exit.

4.11 Boot Menu

The Boot menu in BIOS allows you to specify the system’s boot characteristics by setting bootable device components (boot media) and method. Or, you may press F12 upon system start up and select a device you wish boot from.

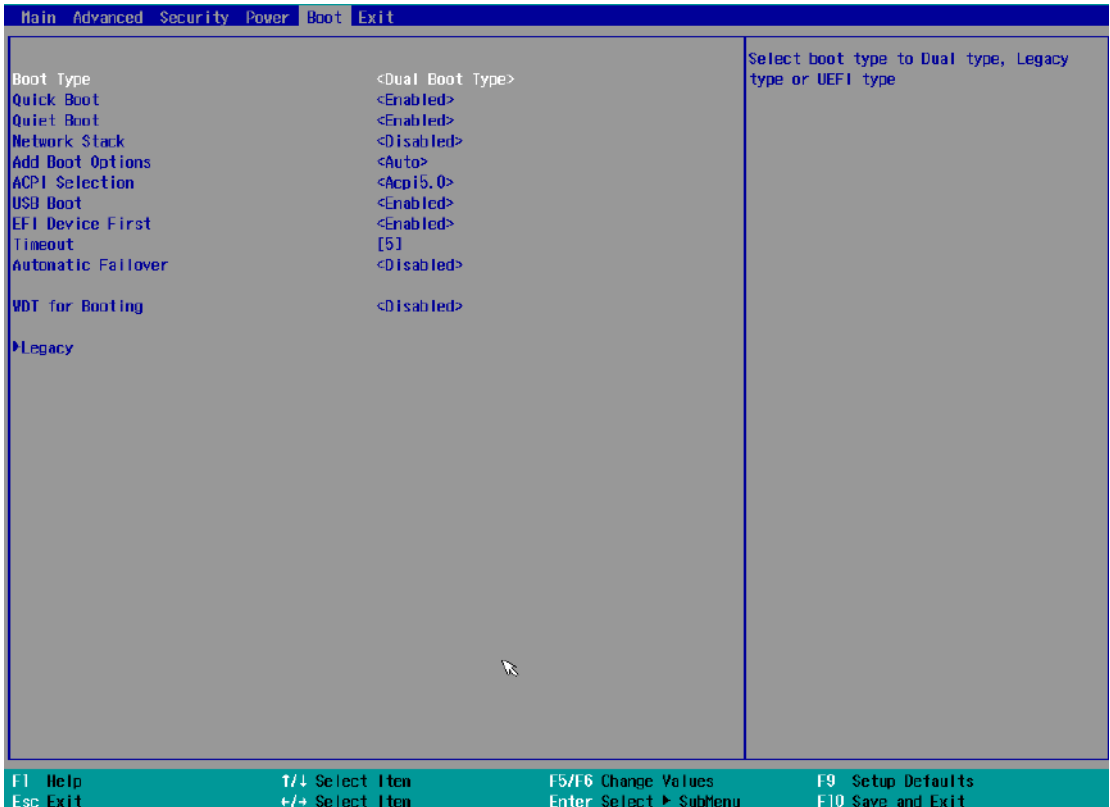



Value	Option	Description
Boot Type	Dual Boot Type	Both legacy and EFI boot media listed are approved as boot media.
	Legacy Boot Type	Only legacy boot media listed are approved as boot media.
	UEFI Boot Type	Only UEFI boot media listed are approved as boot media.
Quick Boot	Enabled	The system starts up faster because BIOS skips various hardware function tests
	Disabled	The system starts up slower because BIOS goes through various hardware functions tests
Network Stack	Enabled	The system is available for network access using UEFI.
	Disabled	The system is not available for network access using UEFI.

Add Boot Options	First	Newly detected boot media are placed at the top of the boot order.
	Last	Newly detected boot media are placed at the bottom of the boot order.
	Auto	Newly detected boot media order will be automatically detected and placed in boot order.
ACPI Selection	4.0/ 5.0/ 6.0/ 6.1	Advanced Configuration and Power Interface allows the operating system to control system power management
USB Boot	Enabled	Allow boot from bootable USB devices.
	Disabled	Does not allow boot from bootable USB devices
EFI Device First	Enabled	Set to boot bootable EFI media first.
	Disabled	Will not boot bootable EFI media first.
Timeout	1, 2, 3, etc (in seconds)	Boot delay time in seconds to give the user time to activate the hotkey to access the BIOS
Automatic Failover	Enabled	Automatically checks for the next bootable device when the set default device fails.
	Disabled	Will only boot from the designated device.
WDT for booting	Disabled, 1, 3, 5, 10 (minutes)	WDT ensures a successful system boot by specifying a timeout value

4.12 Boot Type (Legacy/ UEFI)

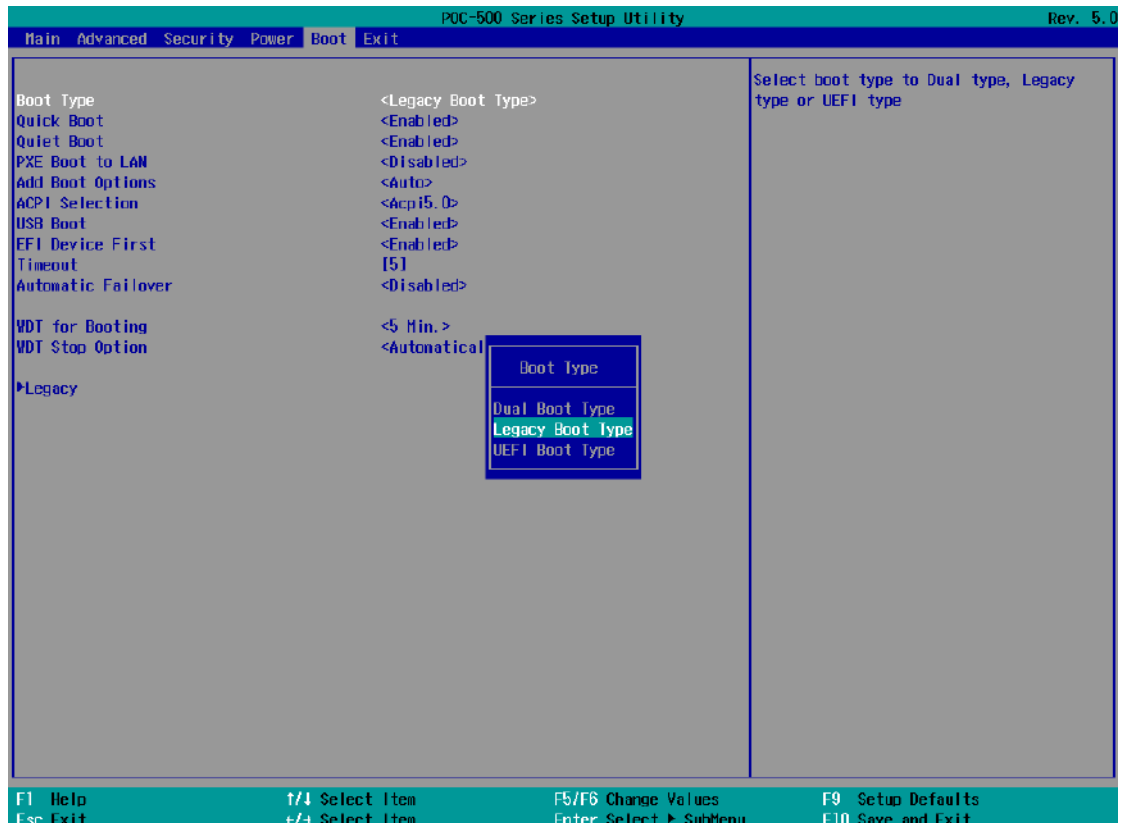
The system supports both Legacy and Unified Extensible Firmware Interface (UEFI) boot modes. UEFI is a specification proposed by Intel to define a software interface between operating system and platform firmware. Most modern operating systems, such as Windows 10 and Linux support both Legacy and UEFI boot modes. The Legacy boot mode uses MBR partition for disk and VBIOS for video initialization, the UEFI boot mode uses GPT partition which supports greater than 2TB partition size and GOP driver for faster video initialization.



 **NOTE**

If you choose Legacy mode, you will not be able to create disk partitions greater than 2TB or use TPM 2.0 function.

To configure Boot Type:

1. When system boots up, press F2 to enter BIOS setup utility.
2. Go to **[Boot]>[Boot Type]**, press ENTER to bring up options, Dual Boot (Legacy+UEFI), Legacy Boot Type, UEFI Boot Type.
3. Highlight your selection and press ENTER.
4. Press F10 to “Exit Saving Changes”.

4.13 Position New Boot Device

The “Add Boot Options” allow you to determine whether a newly added device (eg. USB flash disk) is to boot as the first device to boot or the last in the boot sequence.

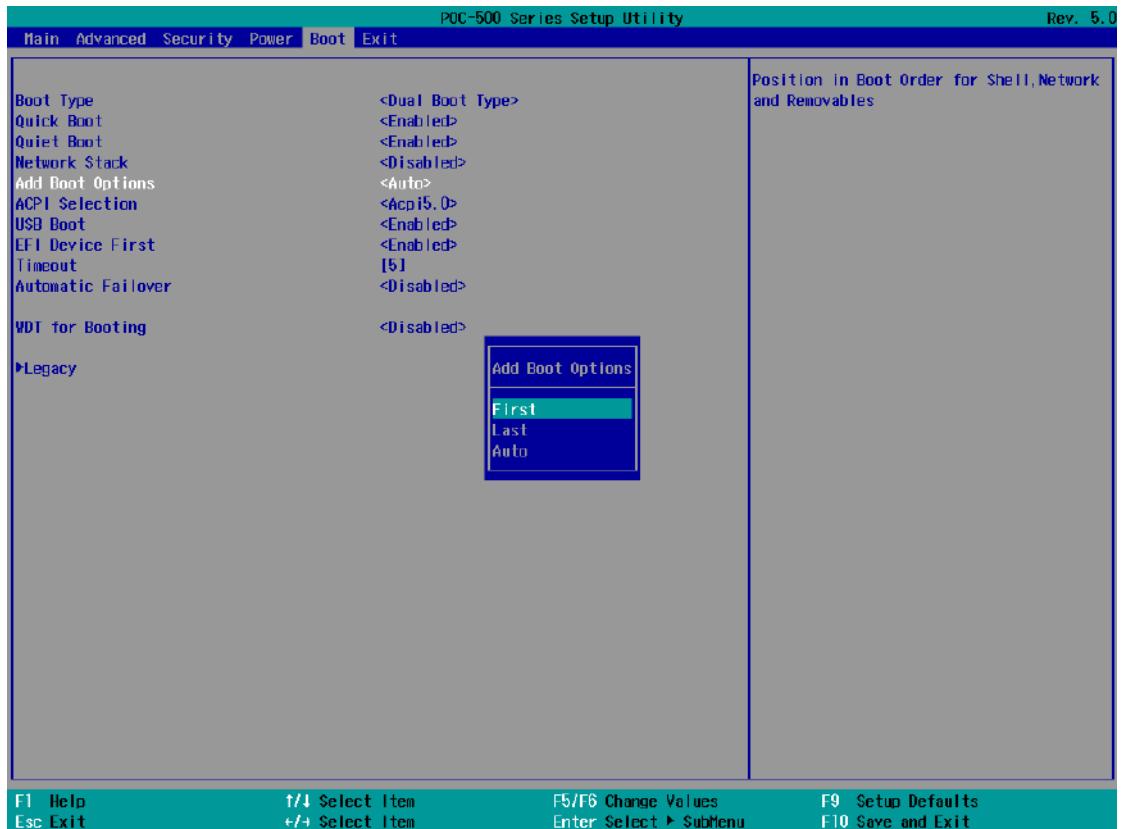

To set the newly-installed boot device as the first or last boot device:

1. Press **F2** when the system boots up to enter the BIOS setup utility.
2. Go to [**Boot**] > [**Add Boot Options**] menu.
3. Select [**First**] or [**Last**] for your newly-added boot device and press Enter.
4. Once set, press **F10** to save setting and exit.

4.14 Watchdog Timer

The watchdog timer secures the boot process by means of a timer. Once the timer expires, a reset command is issued to initiate another booting process. There are two options in BIOS menu, “*Automatically after POST*” and “*Manually after Entering OS*”. When “*Automatically after POST*” is selected, the BIOS automatically stops the watchdog timer after POST (Power-On Self Test) OK. When “*Manually after Entering OS*” is selected, the user must stop the watchdog timer once booted into the OS. This guarantees the system can always boot into the OS, otherwise another booting process will be initiated. For information about programming watchdog timer, please refer to [Appendix A Using WDT & DIO](#).

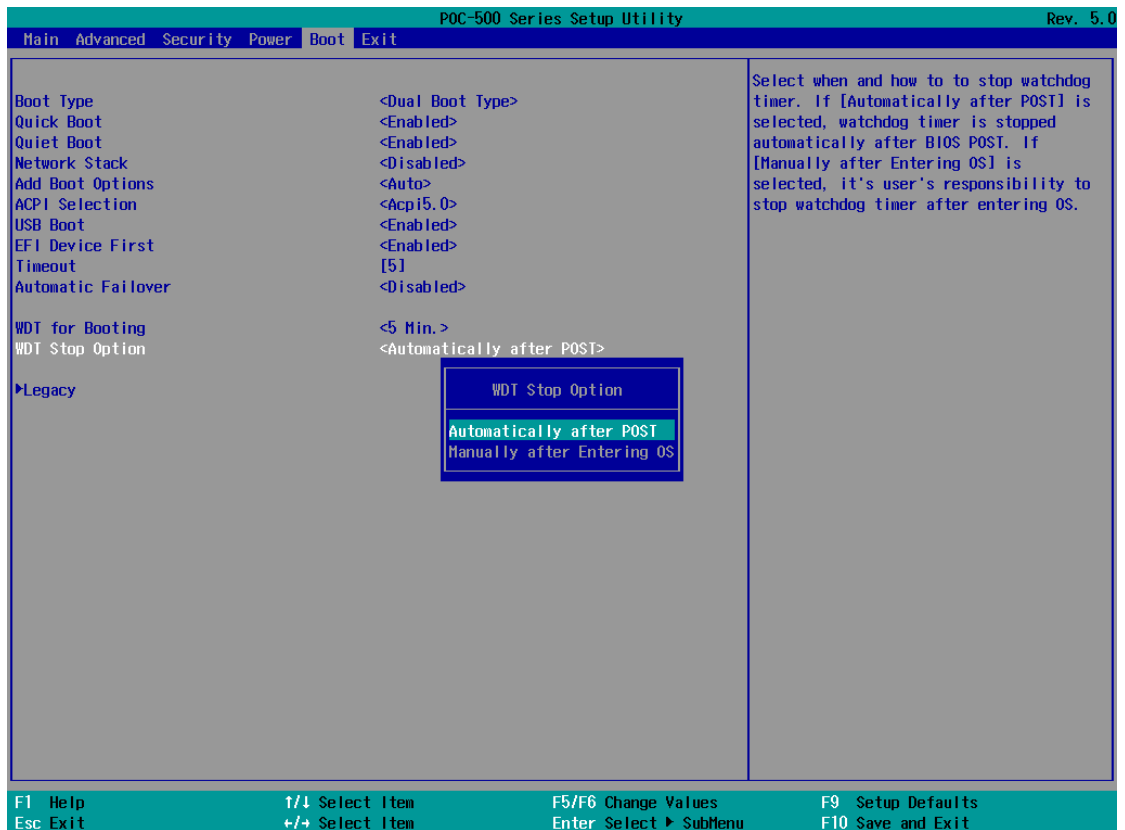

To set the watchdog timer for boot in BIOS:

1. Press **F2** when the system boots up to enter the BIOS setup utility.
2. Go to **[Boot]** menu.
3. Disable or select timeout value for **[WDT for Booting]** option.
4. Once you set a timeout value, the **[WDT Stop Option]** option appears. You can select either “*Automatically after POST*” or “*Manually after Entering OS*”.
5. Once set, press **F10** to save setting and exit.

5 OS Support and Driver Installation

5.1 Operating System Compatibility

POC-500 only has driver support for Windows 10 64-bit. For Linux support, please use Linux kernel versions no later than 4.10. The following list contains the operating systems which have been tested in Neosys Technology.

- Microsoft Windows 10 IoT 2019 LTSC Value
- Microsoft Windows 10 Professional 64-bit RS5
- Ubuntu 18.04.1 LTS* (4.10 kernel)



NOTE

**For Linux system, user may need to manually compile and install the driver for AMD Vega graphics or Intel® I350-AM4 GbE controller if the driver is not embedded in kernel. You can visit AMD website for further information.*

Neosys may remove or update operating system compatibility without prior notice. Please contact us if your operating system of choice is not on the list.

5.2 Driver Installation

The system comes with a “Drivers & Utilities” DVD that offers “one-click” driver installation process. It automatically detects your Windows operating system and installs all necessary drivers for your system with a single click.

5.2.1 Install Drivers Automatically

To install drivers automatically, please refer to the following procedures.

1. Insert the “Drivers & Utilities” DVD into a USB DVD-drive connect to your system. A setup utility launches and the following dialog appears.



2. Click on “**Automatic Driver Installation**” and the setup utility will automatically detect your Windows operating system and install all necessary drivers. The installation process takes about 6~8 minutes depending on your Windows version. Once driver installation is done, the setup utility reboots your Windows and you may begin using your system.

5.2.2 Install Drivers Manually

You can also manually install each driver for the system. Please note when installing drivers manually, you need to install the drivers in the following sequence mentioned below.

Windows 10 (x64)

The recommended driver installation sequence is

1. **Chipset/ graphics driver** (x:\ Driver_Pool\AMD_V1000\Win_10_64\Setup.exe)
2. **Audio driver** (x:\ Driver_Pool\Audio_ALC262\Win_ALL_64\Setup.exe)
3. **LAN driver** (x:\ Driver_Pool\GbE_I210_I350\Win_10_64_CFL\APPS\PROSETDX\Winx64\DxSetup.exe)

5.3 Driver for Watchdog Timer and DIO

Neosys provides a driver package which contains function APIs for WDT function and isolated DIO control function. You should install the driver package (WDT_DIO_Setup.exe) prior to using these functions.



NOTE

Please download from Neosys website and install WDT_DIO_Setup_v2.2.9.9 or later versions.

Appendix A Using WDT & DIO

The watchdog timer (WDT) function ensures reliable system operation. The WDT is a hardware mechanism to reset the system if the watchdog timer is expired. Users can start the WDT and keeping resetting the timer to make sure the system or program is running. Otherwise, the system shall be reset.

In this section, we'll illustrate how to use the function library provided by Neosys to program the WDT functions. Currently, WDT driver library supports Windows 10 x64 and WOW64 platform. For other OS support, please contact Neosys Technology for further information.

Installing WDT_DIO Library

The WDT_DIO function library is delivered in the form of a setup package named **WDT_DIO_Setup.exe**. In prior to program WDT, you should execute the setup program and install the WDT library. Please use the following WDT_DIO_Setup packages according to your operating systems and application.



NOTE

Please download from Neosys website and install WDT_DIO_Setup_v2.2.9.9 or later versions.

WDT and DIO Library Installation

To setup WDT & DIO Library, please follow instructions below.

1. Execute **WDT_DIO_Setup.2.2.9.9.exe**.

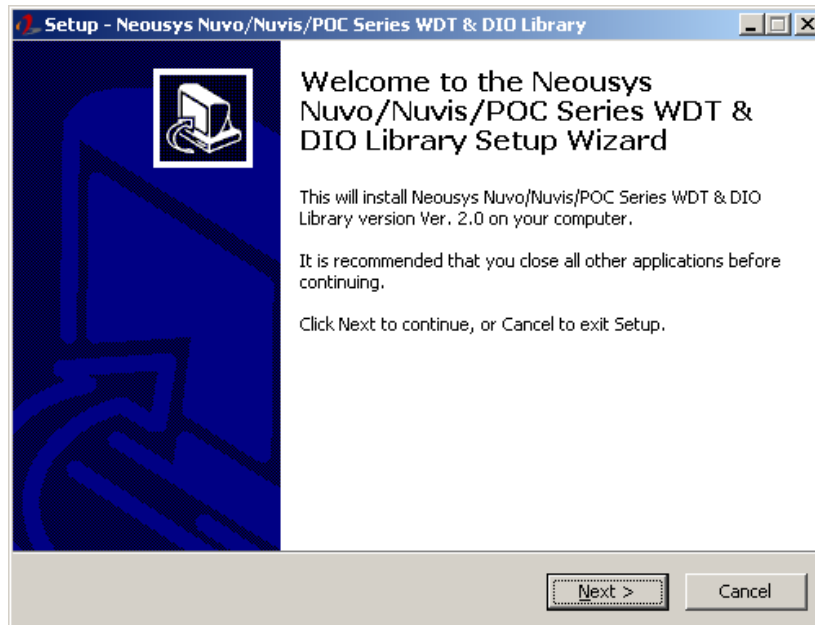

2. Click "Next >" and specify the directory of installing related files. The default directory is *C:\Neosys\WDT_DIO*.

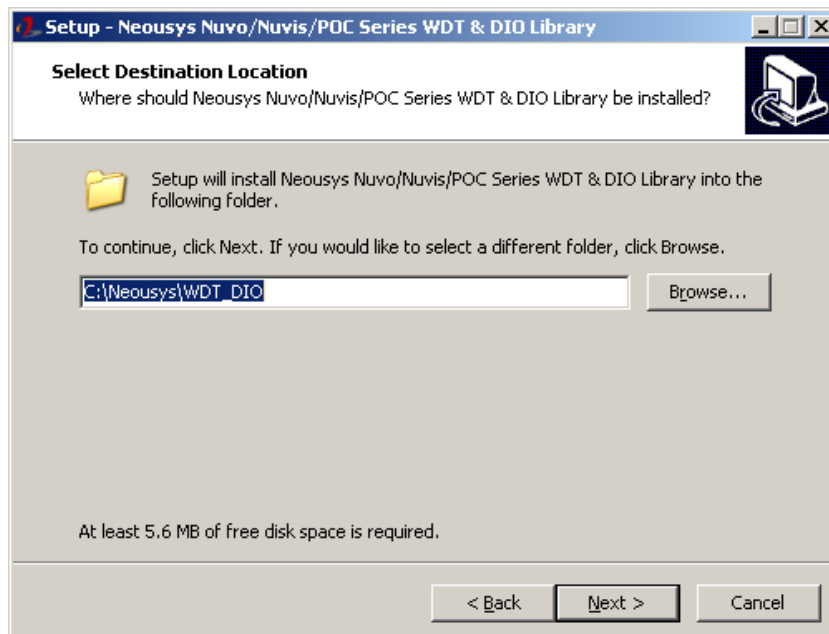

3. Once the installation has finished, a dialog will appear to prompt you to reboot the system. The WDT & DIO library will take effect after the system has rebooted.

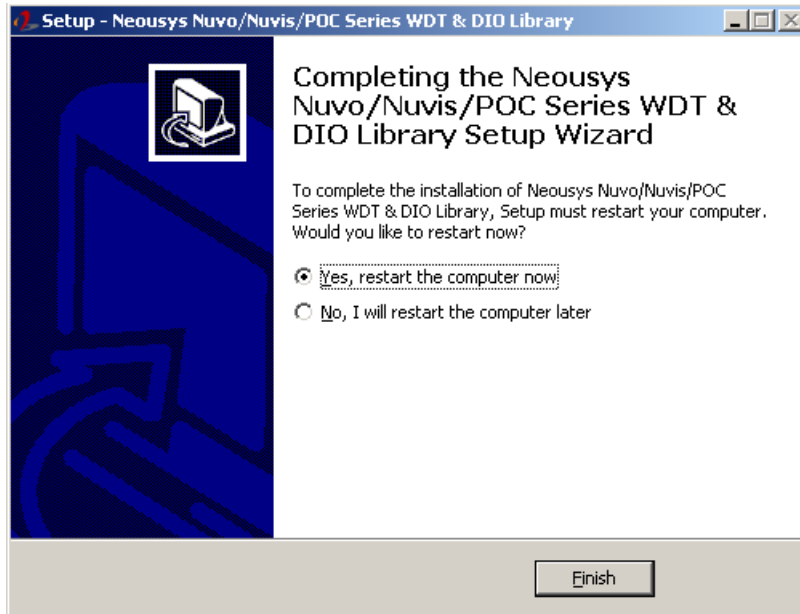

4. When programming your WDT or DIO program, the related files are located in

Header File:	\Include
Library File:	\Lib
Function	\Manual
Reference:	
Sample Code:	\Sample\WDT_Demo (Demo for Watchdog Timer) \Sample\DIO_Demo (Demo for isolated DIO Control) \Sample\COS_Demo (Demo for change-of-state DI)

WDT Function Reference

InitWDT

Syntax	BOOL InitWDT(void);
Description:	Initialize the WDT function. You should always invoke InitWDT() before set or start watchdog timer.
Parameter	None
Return Value	TRUE: Successfully initialized FALSE: Failed to initialize
Usage	BOOL bRet = InitWDT();

SetWDT

Syntax	BOOL SetWDT(WORD tick, BYTE unit);
Description	Set timeout value and unit for watchdog timer. When InitWDT() is invoked, a default timeout value of 255 seconds is assigned.
Parameter	<i>tick</i> WORD value (1 ~ 65535) to indicate timeout ticks. <i>unit</i> BYTE value (0 or 1) to indicate unit of timeout ticks. 0 : unit is minute 1: unit is second
Return Value	If value of unit is correct (0 or 1), this function returns TRUE, otherwise FALSE.
Usage	WORD tick=255; BYTE unit=1; //unit is second. BOOL bRet = SetWDT(tick, unit); //timeout value is 255 seconds

StartWDT

Syntax	BOOL StartWDT(void);
Description	Starts WDT countdown. Once started, the WDT LED indicator will begin blinking. If ResetWDT() or StopWDT is not invoked before WDT countdowns to 0, the WDT expires and the system resets.
Parameter	None
Return Value	If the timeout value is given in correct format (WDT started), this function returns TRUE, otherwise FALSE
Usage	BOOL bRet = StartWDT()

ResetWDT

Syntax	BOOL ResetWDT(void);
Description	Reset the timeout value to the value given by SetWDT().If ResetWDT() or StopWDT is not invoked before WDT countdowns to 0, the WDT expires and the system resets.
Parameter	None
Return Value	Always returns TRUE
Usage	BOOL bRet = ResetWDT()

StopWDT

Syntax	BOOL StopWDT(void);
Description	Stops the countdown of WDT. When WDT has stopped, the WDT LED indicator stops blinking.
Parameter	None
Return Value	Always returns TRUE
Usage	BOOL bRet = StopWDT()

Using DIO Function (POC516/ POC-546 Only)

Wiring for DIO

The digital input function of System series is implemented using a photo-coupler with an internally series-connected 1kΩ resistor. You need to provide a voltage to specify the logic high/low state. The input voltage for logic high is 5~24V, and the input voltage for logic low is 0~1.5V.

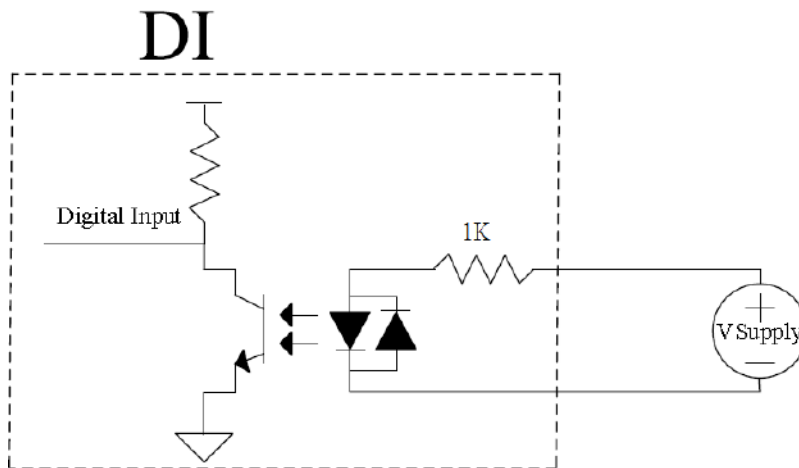

The digital output function of System series is implemented using Power MOSFET + Analog Device iCoupler® component. The DO channels are configured as NO (normally-open) configuration. When you turn on system, all DO channels have a deterministic state of logic 0 (circuit disconnected from GND return). When logic 1 is specified, MOSFET is activated and GND return path is established. The digital output function on System series supports sinking current connection. The following diagrams are the suggested wiring for DO:

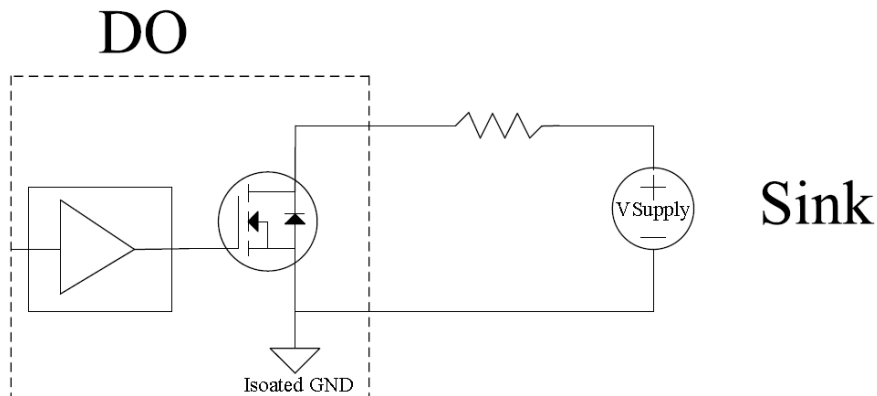

DIO Pin Definition

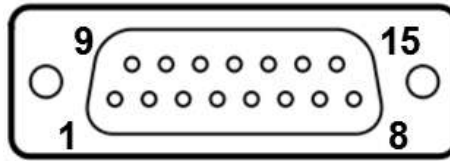

Pin#	Pin Definition	Pin#	Pin Definition
1	DI_0	9	DI_GND
2	DI_1	10	DI_2
3	DI_GND	11	DI_3
4	DO_GND	12	DO_GND
5	DO_0	13	DO_2
6	DO_1	14	DO_3
7	DO_GND	15	-
8	VDD		

DIO Function Reference

InitDIO

Syntax	BOOL InitDIO(void);
Description:	Initialize the DIO function. You should always invoke InitDIO() before write/read any DIO port/channel.
Parameter	None
Return Value	TRUE: Successfully initialized FALSE: Failed to initialize
Usage	BOOL bRet = InitWDT();

DIReadLine

Syntax	BOOL DIReadLine(BYTE ch);
Description:	Read a single channel of isolated digital input.
Parameter	<i>ch</i> BYTE value specifies the DI channel to be read. <i>ch</i> should be a value of 0 ~ 3.
Return Value	The status (TRUE or FALSE) of the specified DI channel.
Usage	BYTE ch=3; //DI channel #3 BOOL DIChValue = DIReadLine(ch); //read DI channel #3

DIReadPort

Syntax	WORD DIReadPort(void);
Description:	Read the entire isolated digital input port (4 channels).
Parameter	None
Return Value	The status (TRUE or FALSE) of the specified DI channel.
Usage	WORD DIPortValue = DIReadPort ();

DOWriteLine

Syntax	void DOWriteLine(BYTE ch, BOOL value);
Description:	Write a single channel of isolated digital output.
Parameter	<p><i>ch</i> BYTE value specifies the DO channel to be written. <i>ch</i> should be a value of 0 ~ 3.</p> <p><i>value</i> BOOL value (TRUE or FALSE) specifies the status of DO channel.</p>
Return Value	None
Usage	<pre> BYTE ch=3; //DI channel #3 BOOL DOChValue=TRUE; DOWriteLine(ch, DOChValue); //write DO channel #3 as TRUE </pre>

DOWritePort

Syntax	void DOWritePort(WORD value);
Description:	Write the entire isolated digital output port (4 channels).
Parameter	<p><i>value</i> WORD value specifies the status of the DO port. <i>value</i> should be a value of 0~15.</p>
Return Value	None
Usage	<pre> WORD DOPortValue=0x0C; //1100b DOWritePort(DOPortValue); //write DO port as 1100b </pre>

DOWriteLineChecked

Syntax	void DOWriteLineChecked(BYTE ch, BOOL value);
Description:	Write a single channel of isolated digital output and read-back the value of DO register. Note that this function is not returned until the DO register is checked and identical to the written value.
Parameter	<p><i>ch</i> BYTE value specifies the DO channel to be written. <i>ch</i> should be a value of 0 ~ 3.</p> <p><i>value</i> BOOL value (TRUE or FALSE) specifies the status of DO channel.</p>
Return Value	None
Usage	<pre> BYTE ch=3; //DI channel #3 BOOL DOChValue=TRUE; DOWriteLineChecked(ch, DOChValue); //write DO channel #3 as TRUE </pre>

DOWritePortChecked

Syntax	void DOWritePortChecked(WORD value);
Description:	Write the entire isolated digital output port (8 channels) and check it has been done. Note that this function is not returned until the write value has been checked the same with the device registry.
Parameter	<p><i>value</i> WORD value specifies the status of the DO port. <i>value</i> should be a value of 0~15.</p>
Return Value	None
Usage	<pre> WORD DOPortValue=0x0C; //1100b DOWritePortChecked(DOPortValue); //write DO port as 1100b </pre>

COS Function Reference

SetupDICOS

Syntax	<pre> BOOL SetupDICOS(COS_INT_SETUP *lpSetup, DWORD cbSetup); </pre>
Description	<p>Setup Digital-Input(DI) Change-of-State(COS) interrupt parameters.</p>
Parameter	<p><i>lpSetup</i> [in] A pointer to a COS_INT_SETUP structure that contains the COS configuration information for the DI device. This data structure contains the following variables:</p> <p><i>portMask</i> WORD value specifies the interrupt mask for corresponding channel(s).</p> <p><i>edgeMode</i> WORD value specifies that interrupt is generated when level change (set to 0) or on rising/falling edge (set to 1) for the corresponding channel(s).</p> <p><i>edgeType</i> WORD value specifies that interrupt is generated on rising edge (set to 0) or falling (set to 1) edge for corresponding channel(s). This value is neglected if <i>edgeMode</i> is set to 0 for the corresponding channel(s).</p> <p><i>cbSetup</i> [in] The length of the structure, in bytes. The caller must set this member to size of (COS_INT_SETUP).</p>
Return Value	<p>TRUE if setup successes FALSE if setup failed</p>
Usage	<pre> COS_INT_SETUP setup; memset(&setup, 0, sizeof(setup)); setup.portMask = 0x0f; // enable ch.0~3 setup.edgeMode = 0; // level setup.edgeType = 0x00; // Lo/Hi BOOL bRet = SetupDICOS(&setup, sizeof(setup)); </pre>

RegisterCallbackDICOS

Syntax	BOOL RegisterCallbackDICOS(COS_INT_CALLBACK callback);
Description:	Registers a callback function, which is called when the DICOS interrupt occurred.
Parameter	callback [in] Specifies the callback function. The prototype for this function is described as follow. void __stdcall callback_func(COS_INT_CALLBACK_ARG* arg);
Return Value	TRUE if setup successes, FALSE if setup failed.
Usage	void __stdcall callback_func(COS_INT_CALLBACK_ARG* arg) { printf("data=0x%02x, flag=0x%02x, seq=%02d\n", arg->portData, arg->intrFlag, arg->intrSeq); } BOOL bRet = RegisterCallbackDICOS(callback_func);

StartDICOS

Syntax	BOOL StartDICOS(void);
Description	Start DI Change-of-State interrupt
Parameter	None
Return Value	TRUE if start procedure successes FALSE if start procedure failed
Usage	BOOL bRet = StartDICOS();

StopDICOS

Syntax	BOOL StopDICOS(void);
Description	Stop DI Change-of-State interrupt
Parameter	None
Return Value	TRUE if stop procedure successes FALSE if stop procedure failed
Usage	BOOL bRet = StopDICOS();

DI COS Example

```

#include <stdio.h>
#include <stdlib.h>
#include <windows.h>
#include "WDT_DIO.h"

//Step 0,   define a Change-of-State Interrupt callback function
void __stdcall callback_function(COS_INT_CALLBACK_ARG* arg)
{
    printf("data=0x%02x, flag=0x%02x, seq=%02d\n",
        arg->portData, arg->intrFlag, arg->intrSeq);
}

int main(int argc, char* argv[])
{
    //Step 1, initialize DIO library by invoking InitDIO()
    if ( ! InitDIO() )
    {
        printf("InitDIO --> FAILED\n");
        return -1;
    }
    printf("InitDIO --> PASSED\n");

    //Step 2, setup Change-of-State Interrupt mask and level/edge mode
    COS_INT_SETUP  setup;

    memset(&setup, 0, sizeof(setup));

    setup.portMask = 0x0f;      // 00001111b, enable ch.0~3
    setup.edgeMode = 0x00;     // generate interrupt on level change
    setup.edgeType = 0x00;     // rising/falling edge, only effective when
    edgeMode = 1

    if ( ! SetupDICOS(&setup, sizeof(setup)) )
    {
        printf("SetupDICOS --> FAILED\n");
        return -2;
    }
    printf("SetupDICOS --> PASSED\n");
}

```

//Step 3, register the callback function

```
if ( ! RegisterCallbackDICOS(callback_function) )
{
    printf("RegisterCallbackDICOS --> FAILED\n");
    return -3;
}
printf("RegisterCallbackDICOS --> PASSED\n");
```

//Step 4, start the DI Change-of-State Interrupt

```
if ( ! StartDICOS() )
{
    printf("StartDICOS --> FAILED\n");
    return -4;
}
printf("StartDICOS --> PASSED\n");
```

```
printf("\npress any key to stop...\n");
system("pause >nul");
```

//Step 5, stop the DI Change-of-State Interrupt operation

```
if ( ! StopDICOS() )
{
    printf("StopDICOS --> FAILED\n");
    return -5;
}
printf("StopDICOS --> PASSED\n");
```

```
printf("\npress any key to exit...\n");
system("pause >nul");
return 0;
```

```
}
```

Appendix B PoE On/ Off Control

The system offers four 802.3at PoE+ ports with a unique feature to allow users manually turn on or off the power supply of each PoE port. This can be function can be useful in power device (PD) fault-recovery or power reset.

The function APIs are encapsulated in Neousys WDT_DIO driver package. Please follow the instructions in [Appendix A Watchdog Timer & Isolated DIO](#) to install the driver package prior to programming PoE on/off control function

PoE On/ Off Control Function Reference

GetStatusPoEPort

Syntax	BYTE GetStatusPoEPort (Byte port);
Description	Get current on/off status of designated PoE port.
Parameter	<i>port</i> BYTE value specifies the index of PoE port. Please refer to the following illustration, <i>port</i> should be a value of 1 ~ 4.
Return Value	BYTE value indicating PoE on/off status 0 if port is disabled (off) 1 if port is enabled (on)
Usage	BYTE bEnabled = GetStatusPoEPort (1); //Get on/off status of PoE Port#1

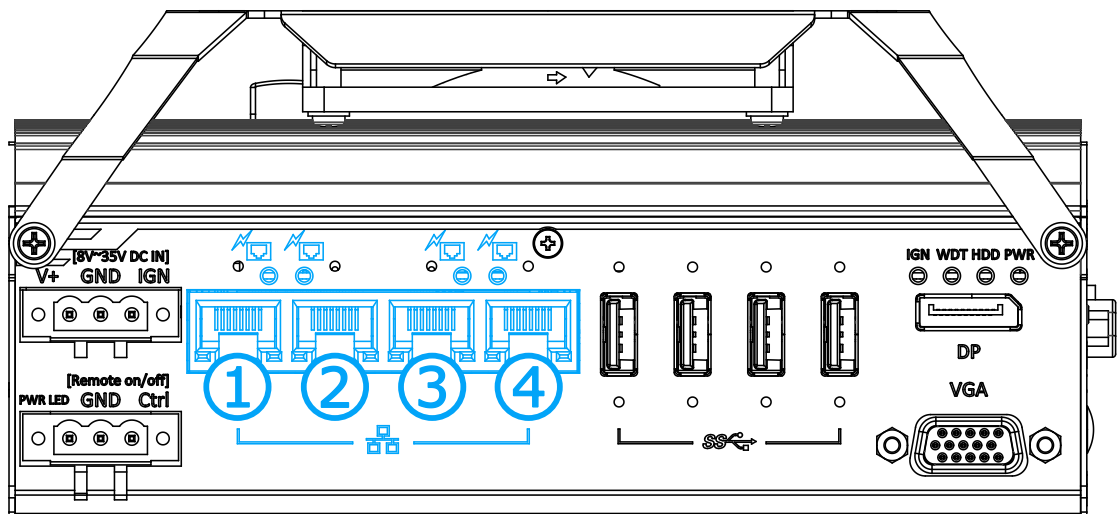

EnablePoEPort

Syntax	BOOL EnablePoEPort (BYTE port);
Description	Turn on PoE power of designated PoE port.
Parameter	<i>port</i> BYTE value specifies the index of PoE port. Please refer to the following illustration, <i>port</i> should be a value of 1 ~ 4
Return Value	TRUE if enabled success FALSE if fail to enable.
Usage	BOOL bRet = EnablePoEPort (1); //Turn on PoE Port#1

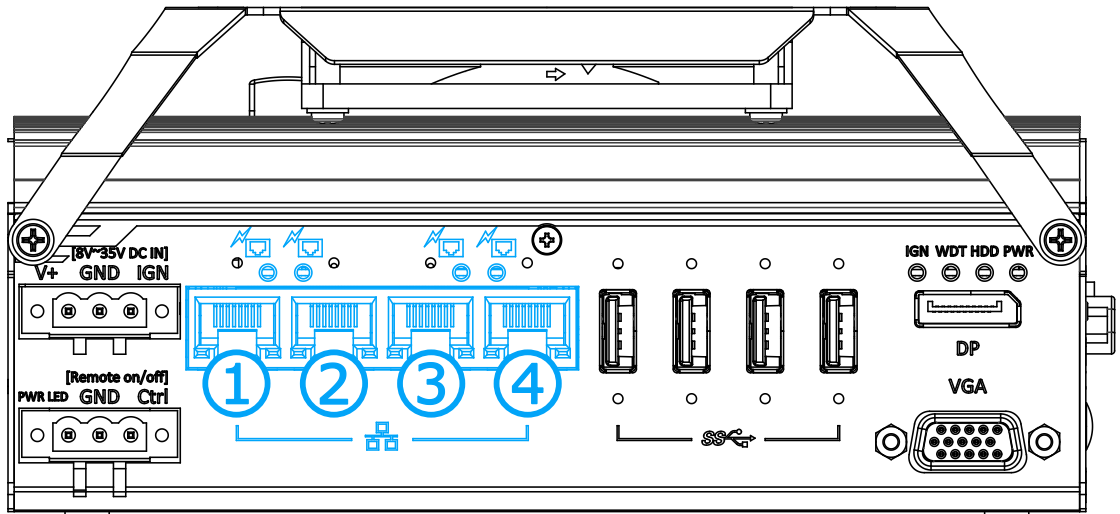

DisablePoEPort

Syntax	BOOL DisablePoEPort (BYTE port);
Description	Turn off PoE power of designated PoE port
Parameter	<i>port</i> BYTE value specifies the index of PoE port. Please refer to the following illustration, <i>port</i> should be a value of 1 ~ 4
Return Value	TRUE if disabled success FALSE if fail to disable
Usage	BOOL bRet = DisablePoEPort (1); //Turn off PoE Port#1

